

Surgiforce
Instruments

Page
101-109

- Syringes and Scissors

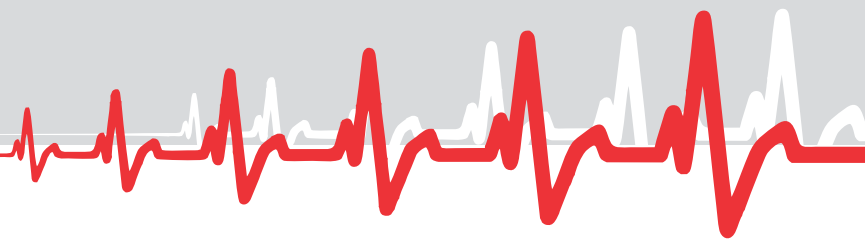



SF-5-5222

Water Syringe complete with 1 cannula (Lure-Lock)



SF-5-5223

Water Syringe complete with 1 cannula (Lure-Lock)



SF-5-5224

Metal water syringe, self-filling, with 1 cannula (Lure-Lock)



SF-5-5225

Sparrel Barrel with plunger suitable for syringes



SF-5-5226

Cannula, only, with Luer-Lock connector suitable for syringes



SF-5-5227
Aspirating Syringe

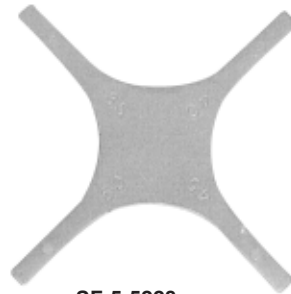

SF-5-5228
Position Gauge

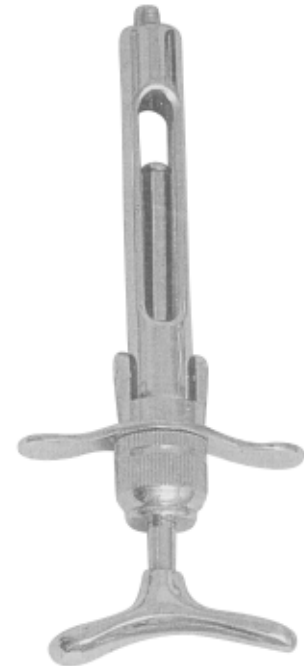

SF-5-5229
Breech Loading Syringe



SF-5-5230
Aspirating & Breech Syringe



SF-5-5231
Band Adaptor



SF-5-5232
Endo Finger Ruler
With Adjustable Slide

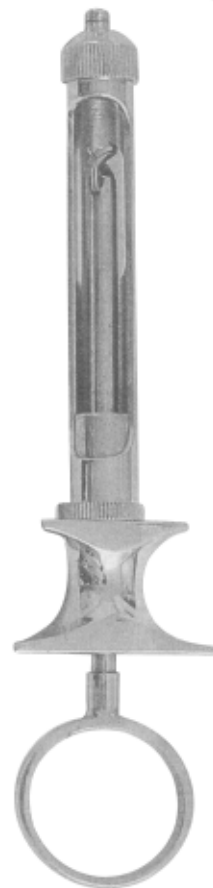

SF-5-5233
Aspirating Syringe



SF-5-5234



SF-5-5236



SF-5-5235



SF-5-5239
Tip Only, short



SF-5-5241



SF-5-5240
Tip Only, long

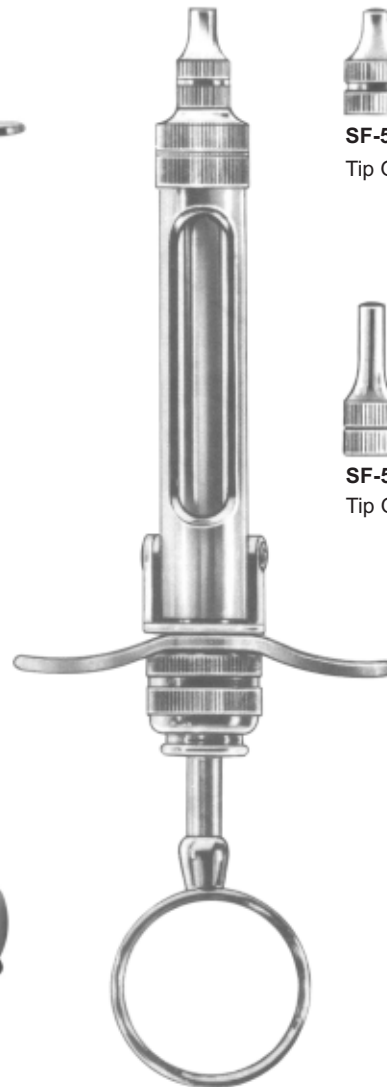

SF-5-5237 1,8 ml
SF-5-5238 2,2 ml
Cartridge Syringe complete
With 2 tips and without needles



SF-5-5242



SF-5-5243



SF-5-5244
Cork screw tip



SF-5-5245
Cork screw tip



SF-5-5246
Folding type, cork
screw tip



SF-5-5247
Folding type, cork
screw tip



SF-5-5248



SF-5-5249
Cork screw tip



SF-5-5250
Spare cap with
metric thread



SF-5-5251
With Whitworth
thread



SF-5-5252
Autoclavable Plastic Protection sleeve



SF-5-5253
Brass syringe with stainless steel moving parts

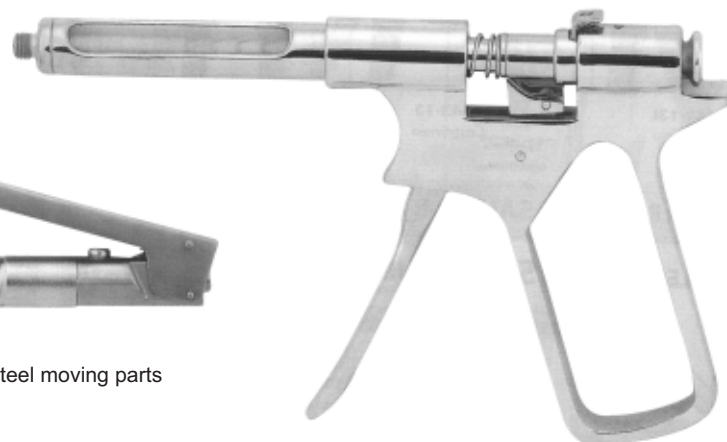

SF-5-5254
Brass syringe with stainless
steel moving parts

Operating Scissors

www.surgiforce.com

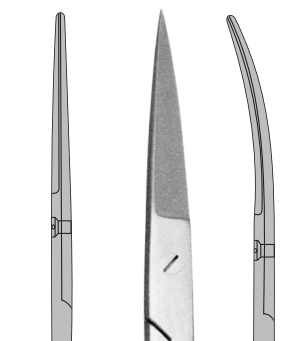

SF-5-5255
11.5 cm
SF-5-5256
13 cm
SF-5-5257
14 cm



Standard
Sharp / Sharp

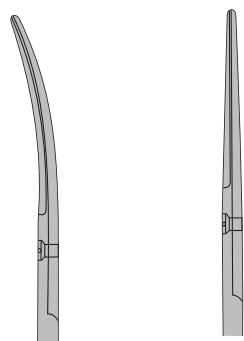

SF-5-5258
11.5 cm
SF-5-5259
13 cm
SF-5-5260
14 cm

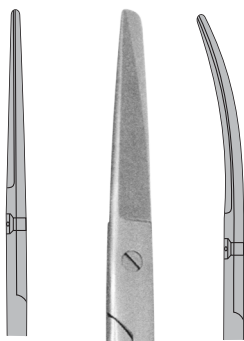

SF-5-5261
11.5 cm
SF-5-5262
13 cm
SF-5-5263
14 cm



Standard
Blunt / Sharp

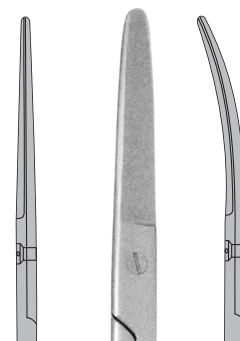

SF-5-5267
11.5 cm
SF-5-5268
13 cm
SF-5-5269
14 cm



Standard
Blunt / Blunt

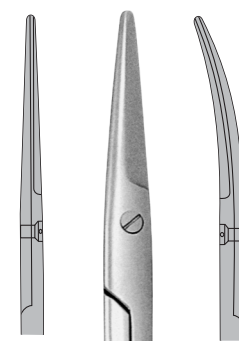

SF-5-5273
11.5 cm
SF-5-5271
13 cm
SF-5-5272
14 cm



Mayo
14.5 cm

Suture Scissors | Tijeras para Hilos | Fadenscheren

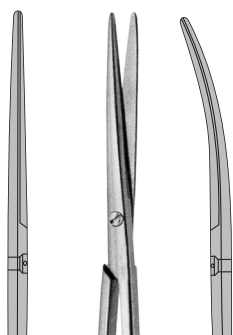

SF-5-5275



Metzenbaum-Delicate
14.5 cm

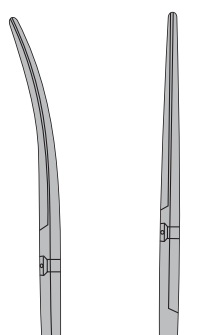

SF-5-5276 **SF-5-5277**



Metzenbaum
14.5 cm



SF-5-5278



SF-5-5279
Littauer
14 cm

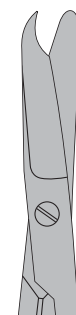

Spencer
SF-5-5280 9 cm
SF-5-5281 13 cm

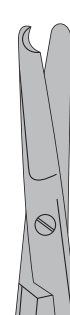

Bandage Scissors Lister
SF-5-5282 9 cm
SF-5-5283 11 cm
SF-5-5284 14 cm
SF-5-5285 18 cm

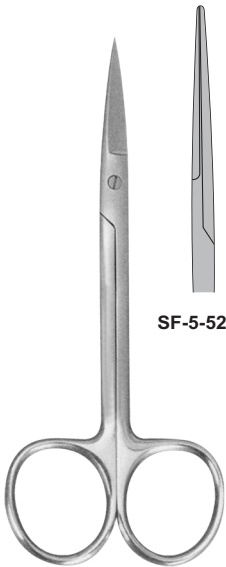

Iris
11.5 cm

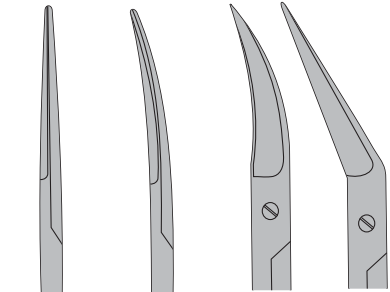

SF-5-5286 SF-5-5287 SF-5-5288 SF-5-5289

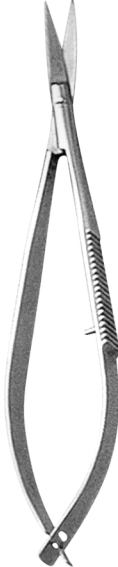

Noyes / Castroviejo
12 cm

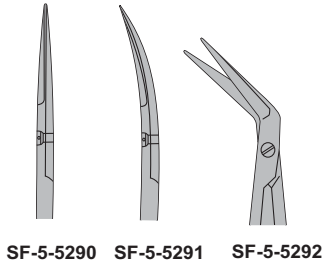

SF-5-5290 SF-5-5291 SF-5-5292

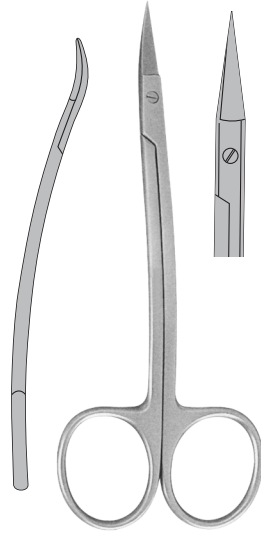

SF-5-52903
La Grange
11.5 cm



SF-5-5294
Universal
18 cm

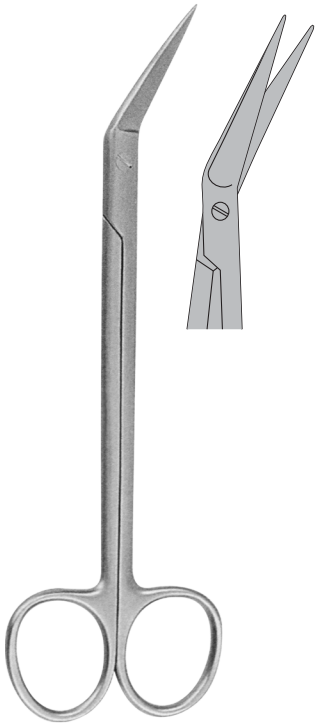

SF-5-5295
Kelly
16 cm

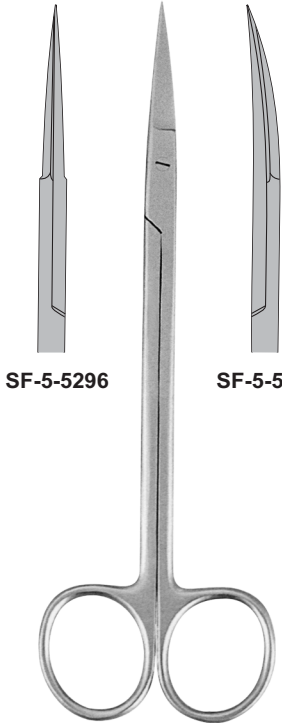

Kelly
16 cm

SF-5-5296

SF-5-5297



SF-5-5298
Goldman-Fox
13 cm

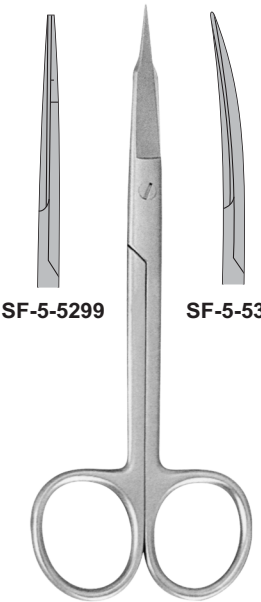

Goldman-Fox
13 cm

SF-5-5299

SF-5-5300

Scissors

www.surgiforce.com

Scissors, One Blade Serrated

- One blade is with fine serrations to avoid tissue or ligature slippage.
- Manufactured from high quality stainless steel to provide longer-lasting cutting edge.
- Single black ring for easy identification.



Iris
11.5 cm



Goldman-Fox
13 cm



SF-5-5306
Goldman-Fox
13 cm

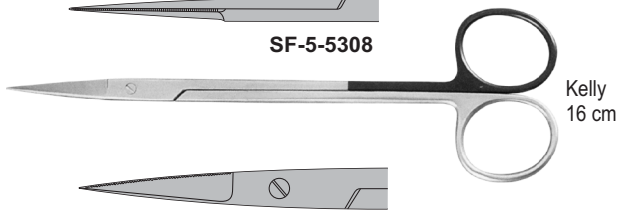
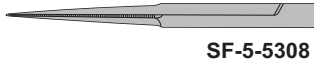
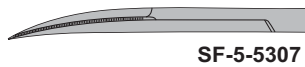

Super-Cut

- Cutting Blade horned to "razor" sharpness with opposing blade finished with fine serrations to avoid tissue slippage.
- Extremely smooth cutting with less trauma.
- Manufactured from high quality stainless steel to provide longer-lasting cutting edge.
- Single gold plated ring for easy identification.

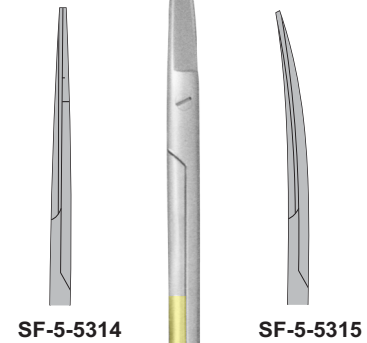
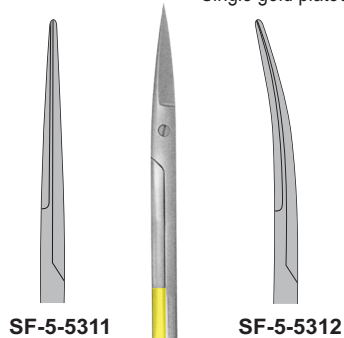



Iris
11.5 cm

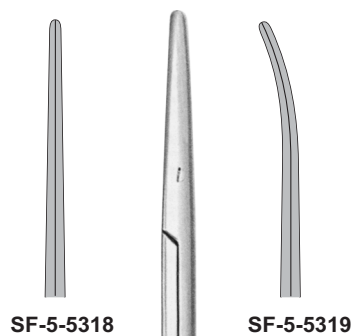

Metzenbaum
14.5 cm

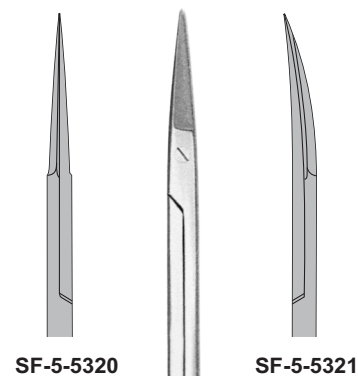

Kelly
16 cm

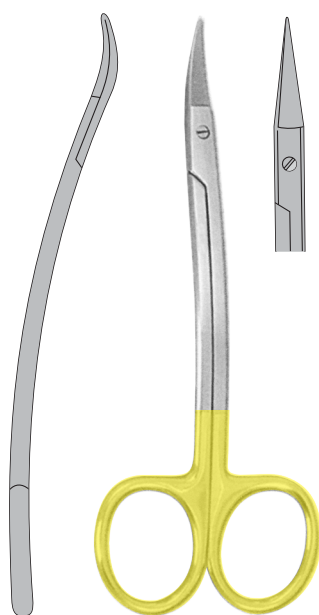

La Grange
11.5 cm

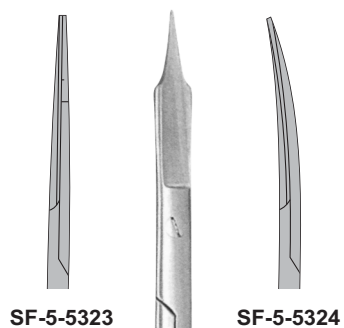

Goldman-Fox
13 cm

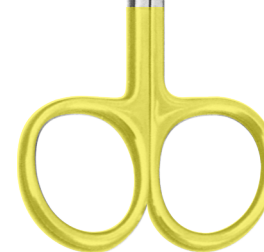
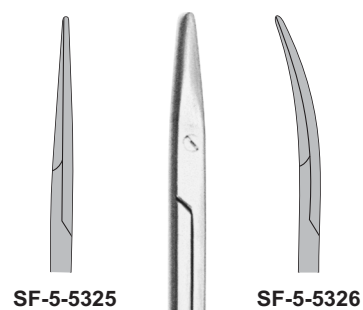

Strabismus
11.5 cm

Micro Scissors

www.surgiforce.com

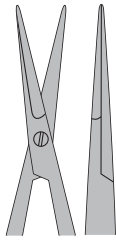
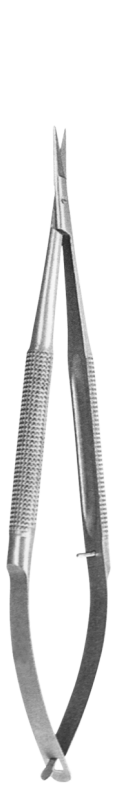

SF-5-5327
15 cm

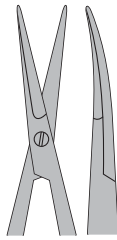

SF-5-5328
15 cm

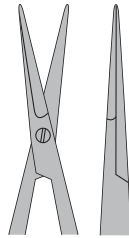
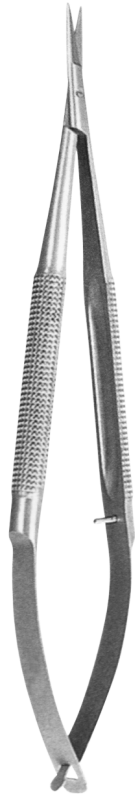

SF-5-5329
18 cm

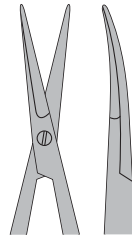

SF-5-5330
18 cm

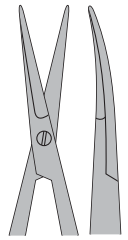

SF-5-5331
18 cm

Micro Scissor
Stainless Steel

Micro Scissor
Stainless Steel

Micro Scissor
Stainless Steel
for ligature, one blade serrated

Micro Scissors with Titanium Stainless Steel Tips

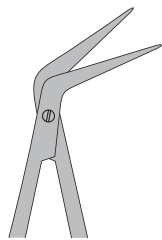
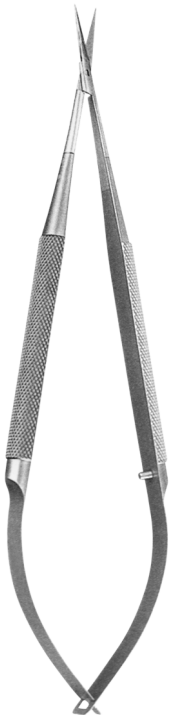

SF-5-5332
18 cm

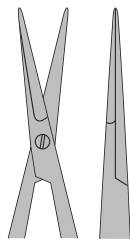

SF-5-5333
18 cm

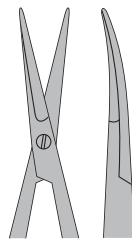

SF-5-5334
18 cm

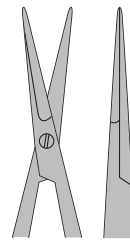

SF-5-5335
15.5 cm

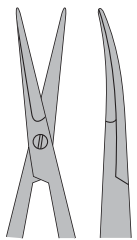

SF-5-5336
15.5 cm



smooth

SF-5-5337
College
15 cm



serrated

SF-5-5338
College
15 cm



smooth

SF-5-5339
College
15 cm



serrated

SF-5-5340
College
15 cm



smooth

SF-5-5341
College
15 cm



serrated

SF-5-5342
College
15 cm



smooth

SF-5-5343
College
15 cm



serrated

SF-5-5344
College
15 cm



Surgiforce Instruments



Opposite Surgical Association,
Malkay Kalan, Marala Road,
Sialkot-51050 Pakistan.



+92 523 559131



info@surgiforce.com
sales@surgiforce.com



www.surgiforce.com

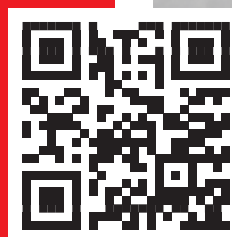

Our Certifications:

ISO 9001

CE Certified

EN 13485:2012

ISO 7153-1

ISO 7151

ISO 17664:2004

ISO 13402

ISO 15223

