

Page 130–151

- Pliers For Orthodontics
- Mouth Gags
- Tongue Depressors
- Lip and Cheek Retractors
- Implantology Instruments

Pinze per formare loops
Loops forming pliers



SF-7-5101
Adams

Adams pliers for bending wires up to 0,7mm. (.28").

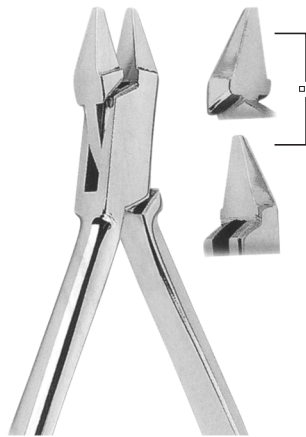

SF-7-5102
Adams

Adams pliers for bending wires up to 0,7mm. (.28").

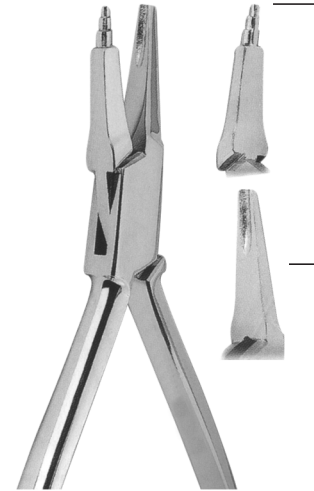

SF-7-5103
Adams

Tweed loop forming pliers. For forming loop in wires up to 0,56 mm. (.22").



SF-7-5104
Adams

Aderer three jaws bending pliers. For wires up to 0,7 mm. (.28").



SF-7-5105
Adams

Aderer three jaws bending pliers. For wires upto 0,7 mm. (.28").

Ligature Cutter Pliers



SF-7-5106

Micro-miniature light wire cutter. It cuts soft ligature wires. For use in caso of limited access. Caution: maximum cutting capacity: soft ligature wire up to 0,30 mm. (.012").



SF-7-5107

Wire cutter. For ligature wires and pins. It is strong enough to bend archwire ends after distal cutting. Maximum cutting capacity up to 0,56 x 0,7 mm. (.022" x .028").

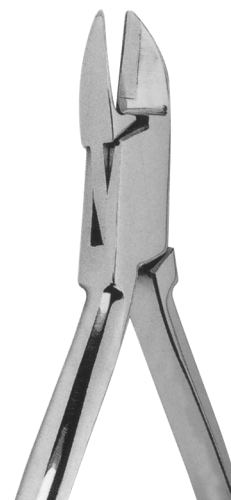

SF-7-5108

Wire cutter. For ligature wires and pins. It is strong enough to bend archwire ends after distal cutting. Maximum cutting capacity: up to 0,9 mm. (.036").



SF-7-5109

Wire cutter. For ligature wires and pins. It is strong enough to bend archwire ends after distal cutting. Maximum cutting capacity: up to 1,5 mm. (.044").

Pinze per formare laboratorio
Laboratory pliers



SF-7-5110

Flat nose pliers with smooth beaks for bending wires up to 0,7 mm. (.028").



SF-7-5111

Bending wires up to 0,7 mm. (.028").



SF-7-5112

Bending wires up to 0,7 mm. (.028").



SF-7-5113

Bending wires up to 0,7 mm. (.028").





SF-7-5114
Nance

Nance loop closing pliers, for bending of stop loops and special for Adams' clasps. Wires up to 0,7 mm. (.028").



SF-7-5115
Nance

Universal pliers for bending wires up to 0,9 mm. (.035") or cutting up to 0,7 mm. (.028").

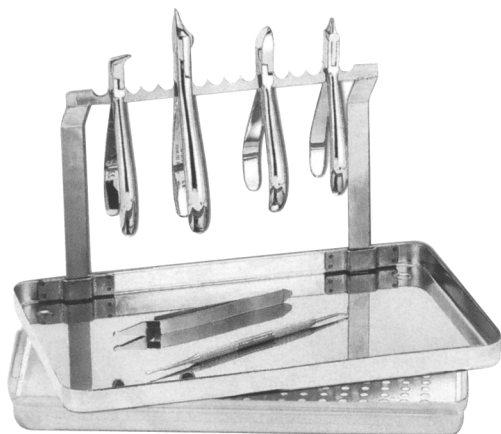

SF-7-5116

Stainless steel pliers tray
standard dimensions



SF-7-5117
Universal

Universal pin roughening, cutting and bending pliers. For wires up to 0,9 mm. (.035"). Will cut wires up to 0,7 mm. (.028").

Utility and specialty pliers



SF-7-5118
Reynolds

Reynolds contouring pliers.



SF-7-5119
Reynolds

Lingual arch pliers used to form double and triple back bends in 0,7 mm (.028") or 0,9 mm (.035") wire for insertion in lingual sheaths.



SF-7-5120
Weingart

Weingart pliers with serrated points.

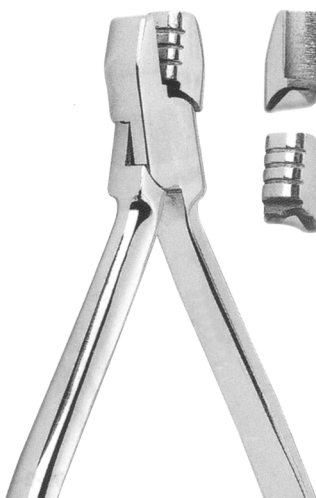

SF-7-5121
De La Rosa

De La Rosa arch forming pliers. Designed to form and contour arch wires on round or rectangular wire. The beak has grooves of 0,4 mm (.016"), 0,46 mm (.018") and 0,56 mm (.022").



SF-7-5122
De La Rosa

Arch forming pliers with a non grooved contouring surface the forming of precise arches.

Loop formare pliers



SF-7-5123
Waldsachs

Waldsachs universal pliers for bending wires up to 1,0 mm. (.039") or cutting up to 0,7 mm. (.028").



SF-7-5124

Round and Concave pliers for loop forming and bending of thin round and square wires up to 0,5 mm. (.020").

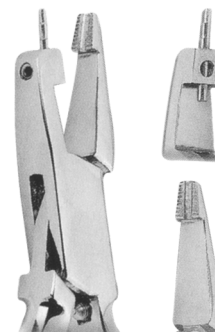

SF-7-5125
Tweed

Tweed loop Forming Pliers. For round or rectangular wires up to 0,56 x 0,7 mm. (.022" x .028"). Replaceable cylindrical beak with three sizes: 1,15 mm. (.045), 1,50 mm. (.059"), 1,90 mm. (.075"). Concave beak with slight parallel serrations, to keep the wire in proper position.

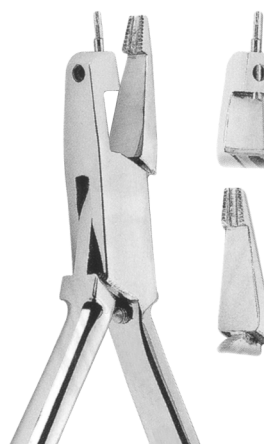

SF-7-5126
Tweed

Tweed Loop Forming Pliers. For making perfect Omega Loops with round or rectangular wires up to 0,56 x 0,7 mm. (.022" x .028"). The concave beak is exactly the same as pliers 5809-1

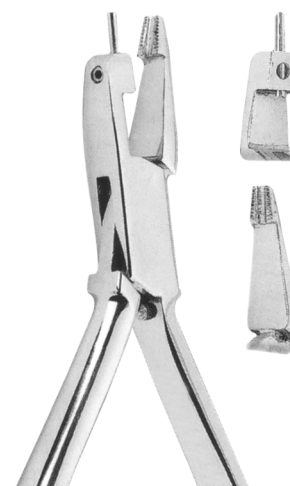

SF-7-5127
Tweed

Single diameter loop forming pliers. Wire up to 0,56 x 0,7 mm. (.022" x 0,28"). Replaceable concave beak has only one diameter section of 1,50 mm. (.059").

Distal end cutters



SF-7-5128

Distal end cutter -safety hold- a precision cutter designed for distal arch cutting in the patient's mouth. It cuts hard wires end holds the loose distal end preventing any damaging of oral tissue. Maximum cutting capacity rectangular wires up to 0,56 x 0,7 mm. (.022" x .020").

D.B. brachet remover pliers



SF-7-5129

Micro- distal end cutter - safety hold-. Similar to 3227



SF-7-5130

Direct bonding bracket remover (wide). The removal grip firmly for easy incisal-gingival (vertical) use or, if needed, for mesial-distal (horizontal) use with the same ease.

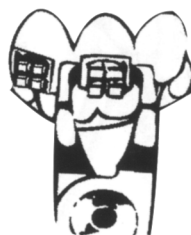

SF-7-5131

Direct bond attachment remover (angled). For removing all bonded attachments. May be used mesial-distal-horizontal) or incisal-gingival (vertical) in anterior areas. Angled perfectly for easy access to difficult posterior areas.

Bird beak pliers



SF-7-5132

Wire bending pliers. For wires up to 0,9 mm. (.036").

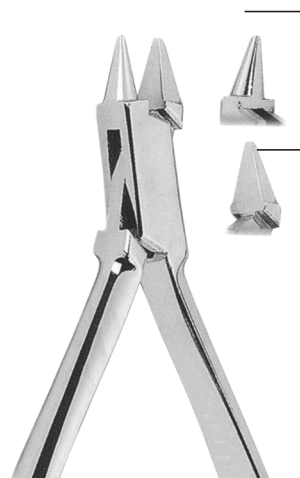

SF-7-5133

Bird Beak Angle pliers for bending round, square or rectangular wire up to 0,7 mm. (.028").

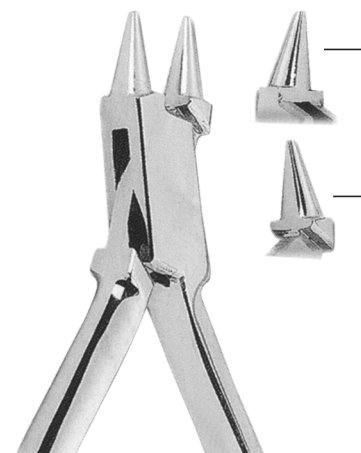

SF-7-5134

Double rounded jaw wire bending pliers. For wires up to 0,7 mm. (.028").



SF-7-5135

Bird beak pliers for bending round, square or rectangular wire up to 0,7 mm. (.028"). With cutter.



SF-7-5136

Double rounded jaw wire bending pliers. For wires up to 0,7 mm. (.028").



SF-7-5137
USA Model
125 mm



SF-7-5138
Waldron
125 mm

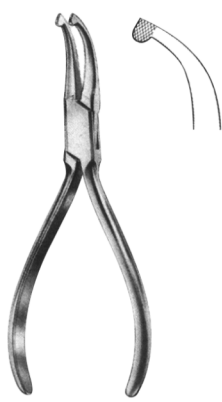

SF-7-5139
How
140 mm



SF-7-5140
How
145 mm

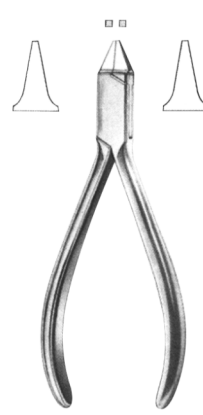

SF-7-5141
Adams
125 mm

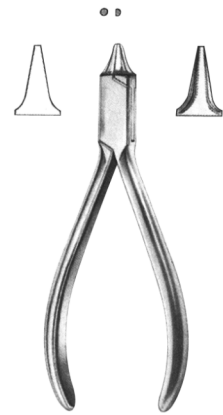

SF-7-5142
Angle
125 mm



SF-7-5143
young
130 mm



SF-7-5144
Nance
130 mm



SF-7-5145
Weingart
140 mm



SF-7-5146
Johnson
130 mm



SF-7-5147
Mc Kellops
155 mm

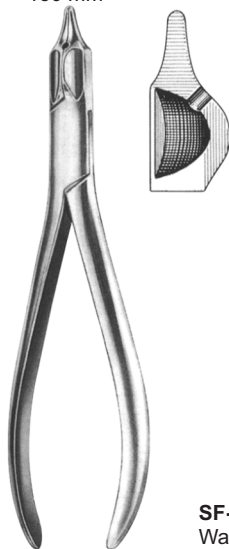

SF-7-5148
Universal
150 mm

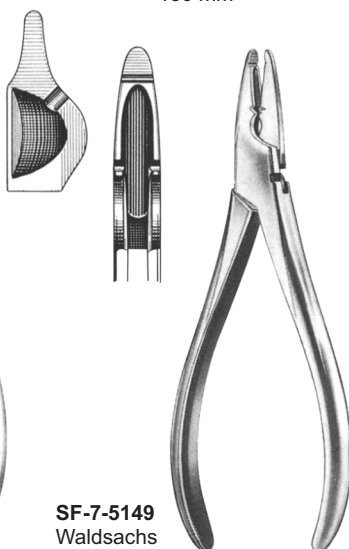

SF-7-5149
Waldsachs
155 mm

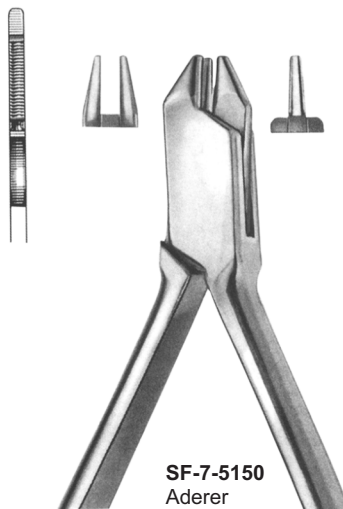

SF-7-5150
Aderer
125 mm



SF-7-5151
Nance
130 mm

Pliers for Othodontics and Prosthetics

www.surgiforce.com



SF-7-5152
Langenbeck
140 mm



SF-7-5153
Langenbeck
130 mm



SF-7-5154
Langenbeck
130 mm



SF-7-5155
Peeso
125 mm



SF-7-5156
Goslee
125 mm

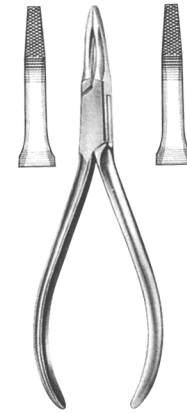

SF-7-5157
Fischer
140 mm

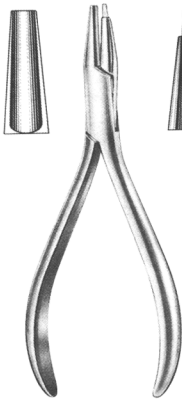

SF-7-5158
Andresen
130 mm

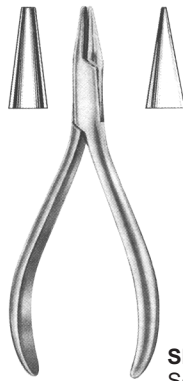

SF-7-5159
Schwarz
130 mm

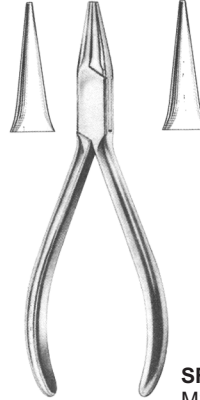

SF-7-5160
MSY
130 mm

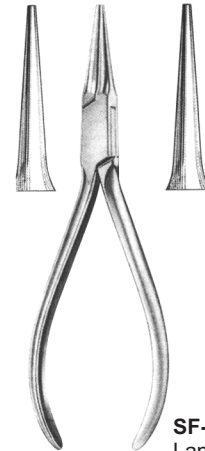

SF-7-5161
Langenbeck
125 mm



SF-7-5162

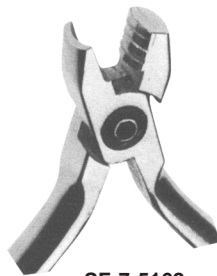

SF-7-5163



SF-7-5164



SF-7-5165



SF-7-5166

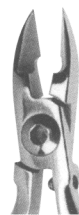

SF-7-5167

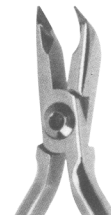

SF-7-5168



SF-7-5169

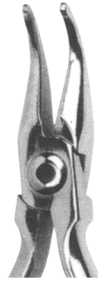

SF-7-5170

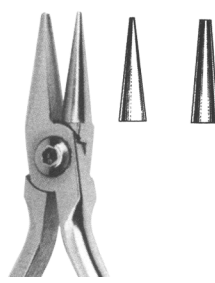

SF-7-5171

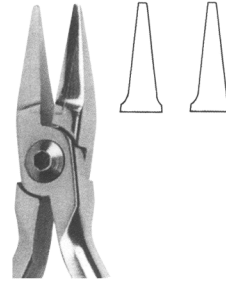

SF-7-5172

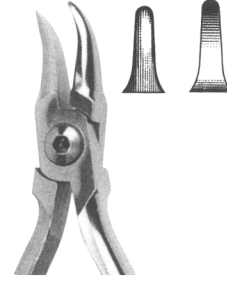

SF-7-5173

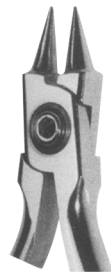

SF-7-5174

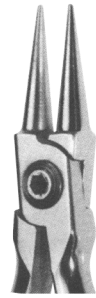

SF-7-5175

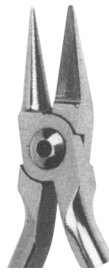

SF-7-5176

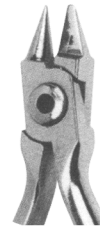

SF-7-5177



SF-7-5178

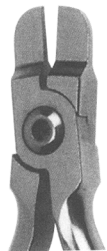

SF-7-5179

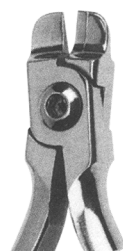

SF-7-5180



SF-7-5181

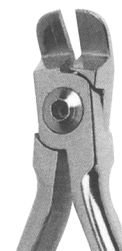

SF-7-5182

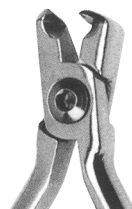

SF-7-5183

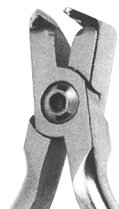

SF-7-5184

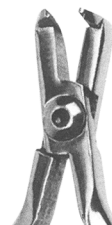

SF-7-5185



SF-7-5186

Mouth Gags

www.surgiforce.com



Molt
SF-7-5187 10 cm
SF-7-5188 11 cm
SF-7-5189 14 cm



SF-7-5190 16 cm
SF-7-5191 19 cm
 Roser-König

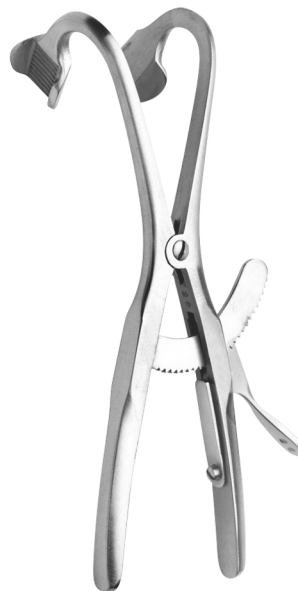

SF-7-5192
 Denhardt
 13 cm



SF-7-5193
 Fergusson - Ackland
 14.5 cm



SF-7-5194
 Heister
 Maunder Wood
 9.5 cm



SF-7-5195
 Obwegeser 11 cm
 Spreading 47 mm



SF-7-5196
 Heister
 13 cm



SF-7-5197 Small
SF-7-5198 Medium
SF-7-5199 Large
 Cheek Retractor

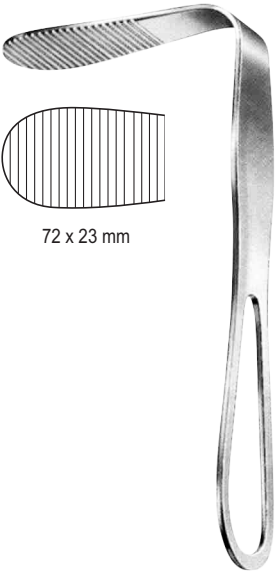

72 x 23 mm

SF-7-5200
Hartmann
15 cm



SF-7-5201
Doyen Tongue Spatula
13.5 cm



SF-7-5202
14.5 cm



SF-7-5203
18 cm



SF-7-5204
Bruenings
19 cm

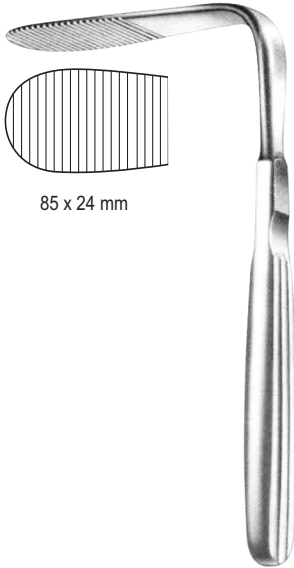

85 x 24 mm

SF-7-5205
Tobold
15 cm

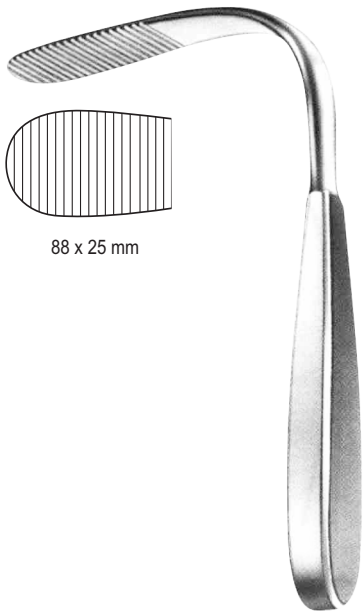

88 x 25 mm

SF-7-5206
Tobold
16 cm

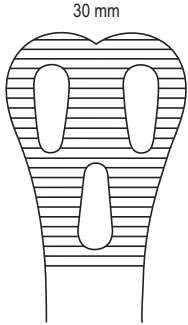

30 mm

SF-7-5207
14 cm

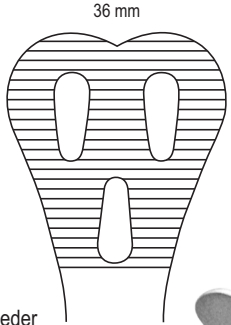

36 mm

Wieder

SF-7-5208
15 cm

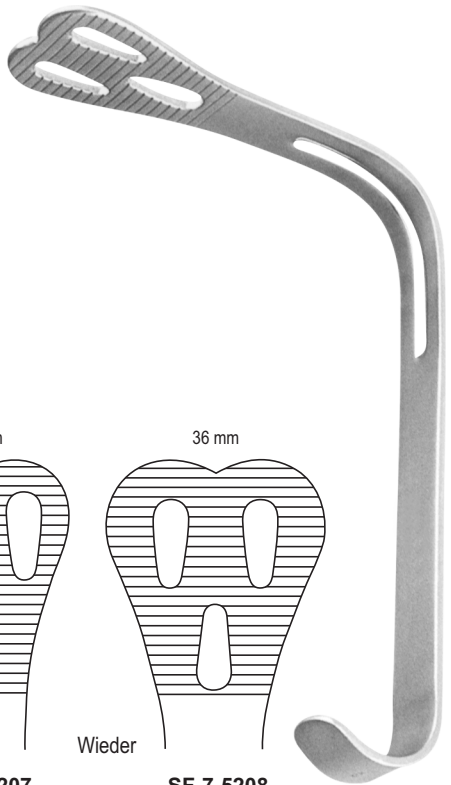

Lip and Cheek Retractors

www.surgiforce.com



SF-7-5209
Obwegeser Chin
Retractor
16.5 cm



Obwegeser 16 cm
SF-7-5210 8 mm
SF-7-5211 10 mm



SF-7-5212 43 x 11 mm
SF-7-5213 57 x 11 mm
SF-7-5214 83 x 16 mm



35 x 11 mm

SF-7-5215
Obwegeser
Spina-nasalis retractor
22 cm



72 x 11 mm

SF-7-5216
Obwegeser
Ramus retractor for
separation of ramus & tissue
22 cm



SF-7-5217
Simplex
10.5 cm

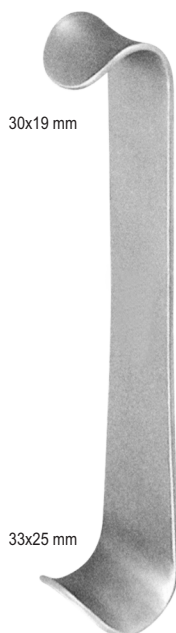

30x19 mm

33x25 mm

SF-7-5218
Kilner
15 cm



SF-7-5219
Minnesota
14 cm



SF-7-5220
Cawood-Minnesota
15 cm



SF-7-5221
Austin



SF-7-5222
Hilger
Fits any simple stem mouth mirror handle



SF-7-5223
Hilger
with handle

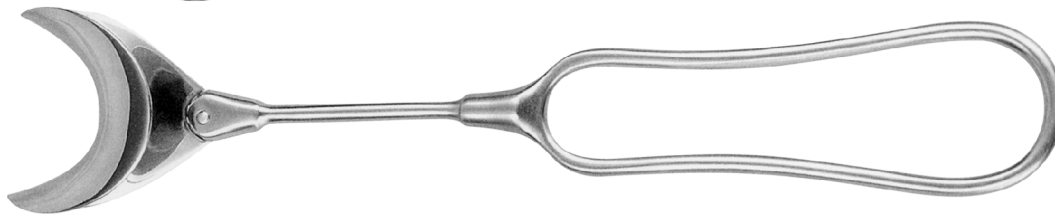

SF-7-5224
Max
20 cm

Finger protectors



Langenbeck

SF-7-5225 Small
SF-7-5226 Medium
SF-7-5227 Large

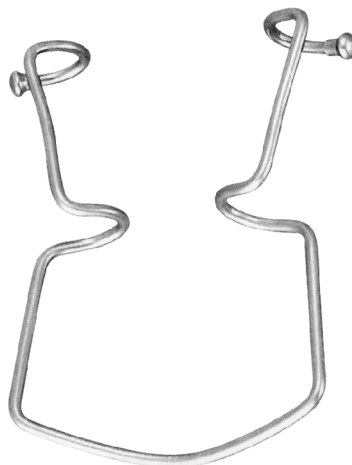

SF-7-5228
Oringer
11.5 cm

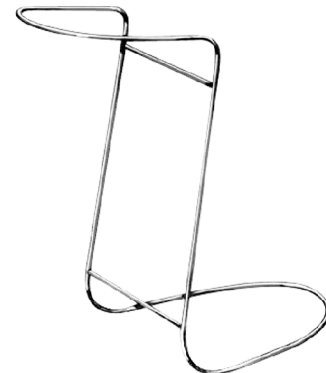

SF-7-5229
Obwegeser Cheek Retractor
12cm

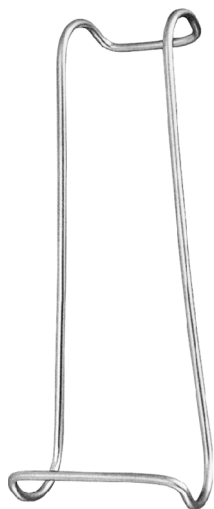

SF-7-5230
Columbia
14.5 cm



Sternberg

SF-7-5231 12 cm
SF-7-5232 14 cm
SF-7-5233 15 cm



Vestibulum
SF-7-5234



SF-7-5235
Max

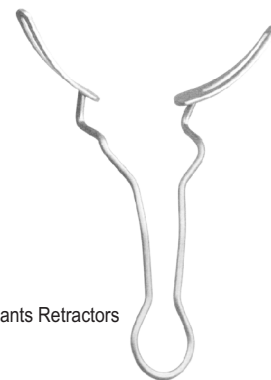

Implants Retractors

SF-7-5236
Max

Retractors

www.surgiforce.com

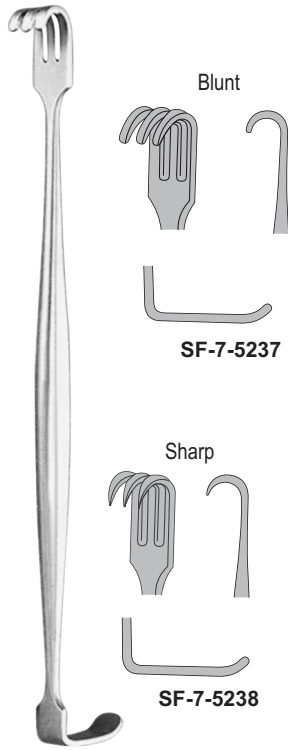

Blunt

SF-7-5237

Sharp

SF-7-5238

Senn-Miller
16 cm

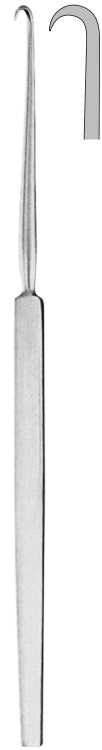

Sharp

SF-7-5239

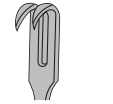

SF-7-5240



SF-7-5241



SF-7-5242

Max
16 cm

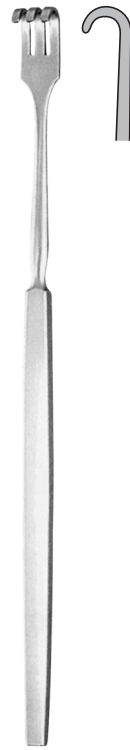

Blunt

SF-7-5243



SF-7-5244



SF-7-5245



SF-7-5246

Max
16 cm

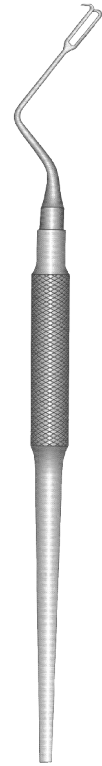

Kirkland
Gum & Tissue
Retractors

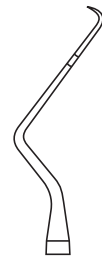

SF-7-5247
Fig. 23 K



SF-7-5248
Fig. 24 K

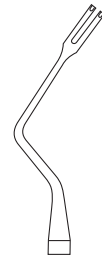

SF-7-5249
Fig. 27 K

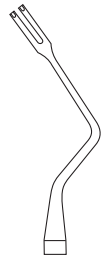

SF-7-5250
Fig. 28 K



SF-7-5251
Collin Tongue holding forceps
17 cm



SF-7-5254
Rubber Pad pair

Young Tongue holding forceps
SF-7-5252 15 cm
SF-7-5253 17 cm



SF-7-5255
Farabeuf 12 cm
Pair

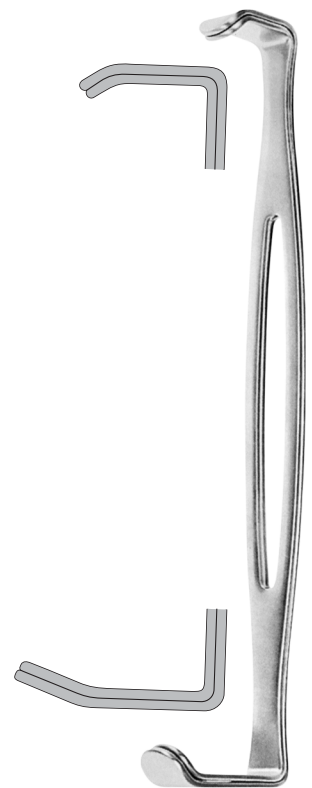

SF-7-5256
Parker-Langenbeck 21 cm
Pair

Osteotomes



15.5 cm

# 1	Diam.
0	Ø 1.60
7.5	Ø 1.80
10	Ø 2.00
13.5	Ø 2.40
15.5	Ø 3.60

1
Ø 1.6 mm



SF-7-5257
15.5 cm

# 2	Diam.
0	Ø 1.90
7.5	Ø 2.20
10	Ø 2.35
13.5	Ø 3.30
15.5	Ø 3.40
23.5	Ø 4.50

2
Ø 1.9 mm



SF-7-5258
15.5 cm

# 3	Diam.
0	Ø 2.80
7.5	Ø 3.20
10.5	Ø 3.35
13.5	Ø 3.60
21	Ø 4.40

3
Ø 2.8 mm



SF-7-5259
15.5 cm

# 4	Diam.
0	Ø 3.10
7.5	Ø 3.70
10.5	Ø 3.90
15.5	Ø 4.30

4
Ø 3.10 mm



SF-7-5260
15.5 cm

# 5	Diam.
0	Ø 3.90
10	Ø 5.00
13	Ø 5.20
20.5	Ø 6.30

5
Ø 3.90 mm



SF-7-5261
15.5 cm

# 6	Diam.
0	Ø 5.50
10	Ø 6.20
13	Ø 6.30

6
Ø 5.50 mm



SF-7-5262
15.5 cm

# 1	Diam.
0	Ø 1.50
5	Ø 1.90
8	Ø 2.20
10	Ø 2.40
12	Ø 2.60
14	Ø 2.80

1
Ø 1.5 mm



SF-7-5263
15.5 cm

# 2	Diam.
0	Ø 2.10
5	Ø 2.60
8	Ø 2.80
10	Ø 3.00
12	Ø 3.20
14	Ø 3.40

2
Ø 2.1 mm



SF-7-5264
15.5 cm

# 3	Diam.
0	Ø 2.60
5	Ø 3.00
8	Ø 3.30
10	Ø 3.50
12	Ø 3.70
14	Ø 3.90

3
Ø 2.6 mm



SF-7-5265
15.5 cm

# 4	Diam.
0	Ø 3.00
5	Ø 3.50
8	Ø 3.80
10	Ø 4.00
12	Ø 4.20
14	Ø 4.40

4
Ø 3.0 mm



SF-7-5266
15.5 cm

# 5	Diam.
0	Ø 3.50
5	Ø 3.90
8	Ø 4.20
10	Ø 4.40
12	Ø 4.60
14	Ø 4.80

5
Ø 3.5 mm



SF-7-5267
15.5 cm

Ø 2.8 mm



SF-7-5268
15.5 cm

Ø 3.5 mm



SF-7-5269
15.5 cm

Ø 4.2 mm



SF-7-5270
15.5 cm

Spelling Straight
Bone Pusher

Osteotomes

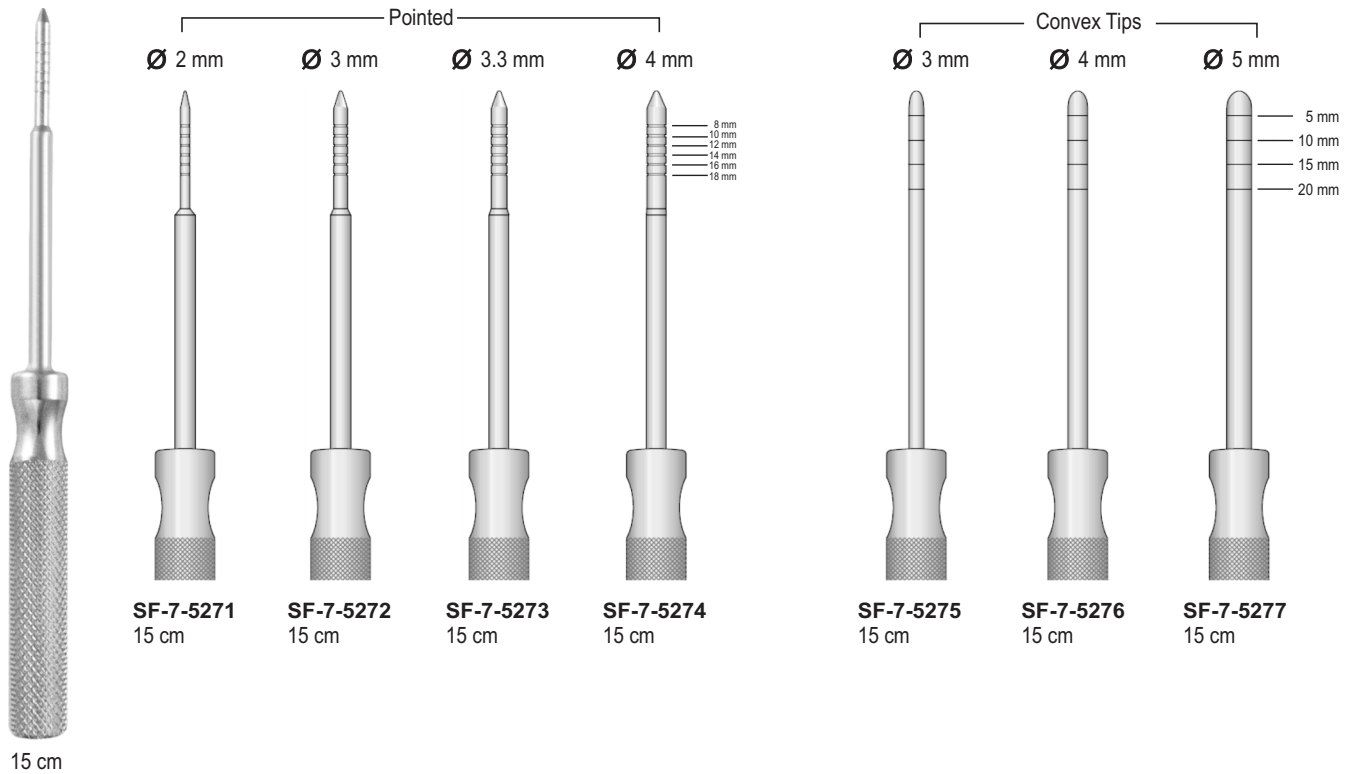

Convex Tips

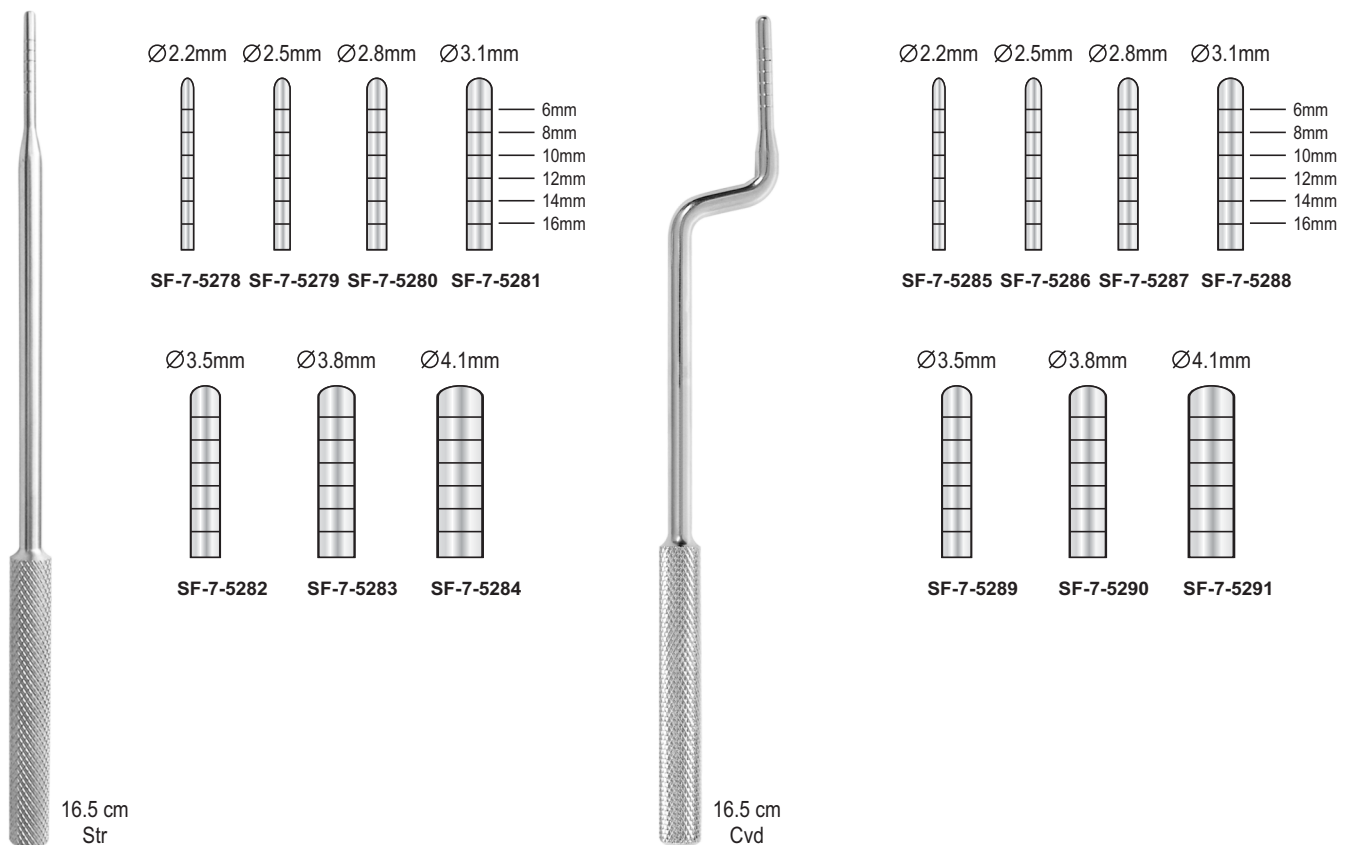

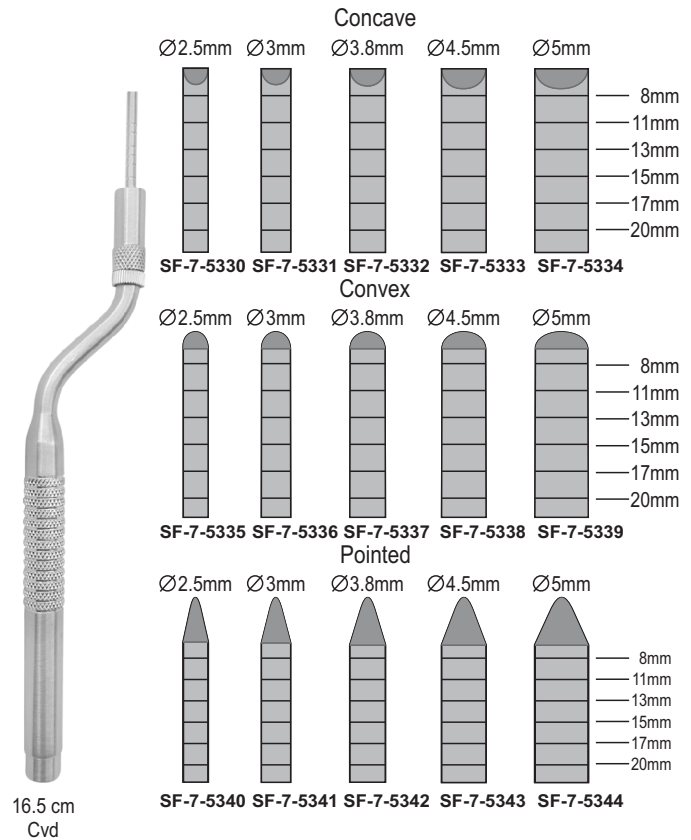
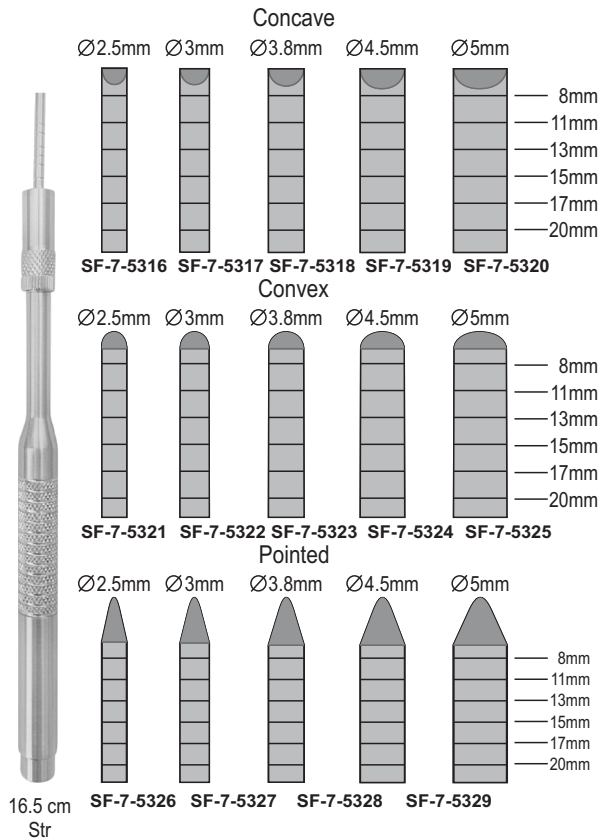
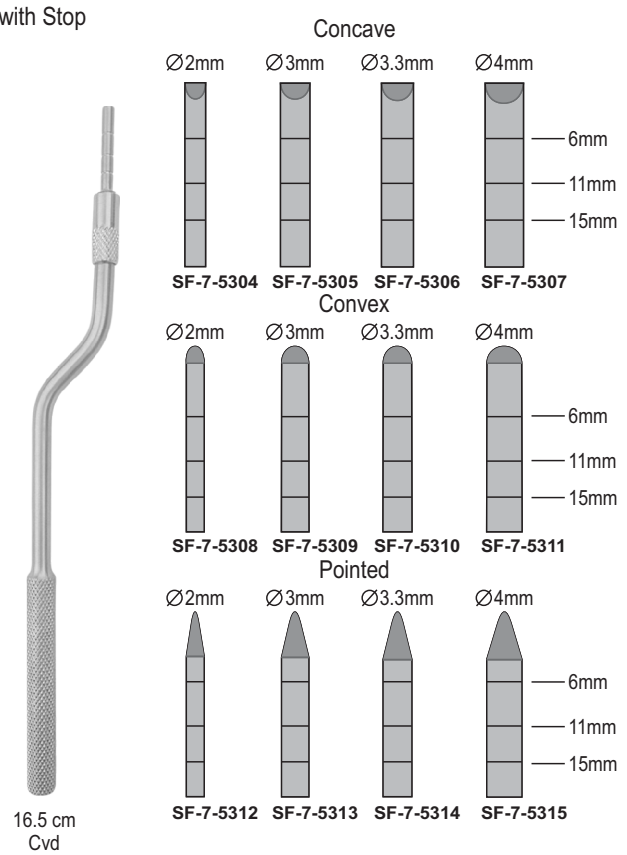
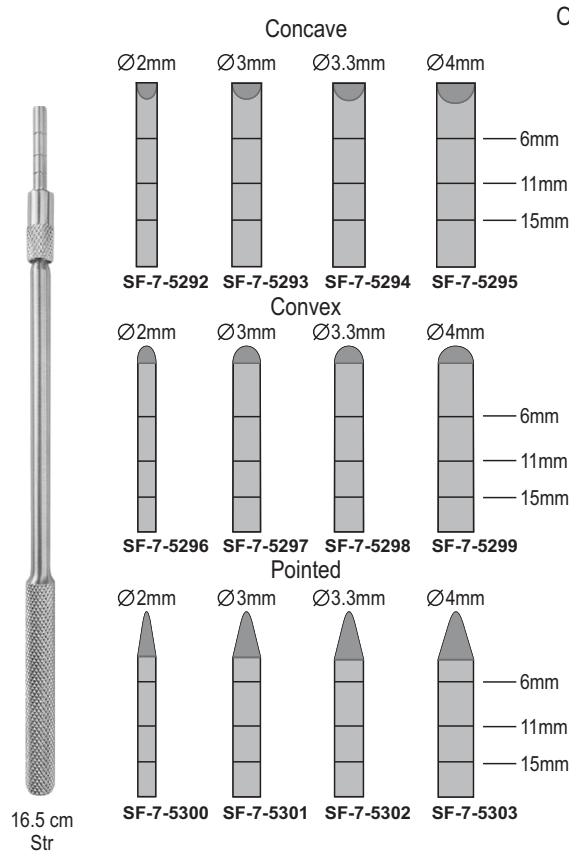

PDL Elevators



SF-7-5345 Distal, 2.5 mm Micro Edge

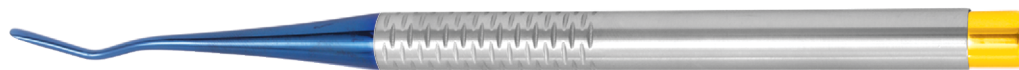

SF-7-5346 Mesial, 2.5 mm Micro Edge

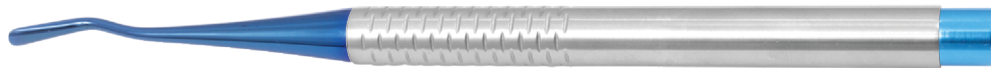

SF-7-5347 Distal, 4 mm Micro Edge



SF-7-5348 Mesial 4 mm Micro Edge

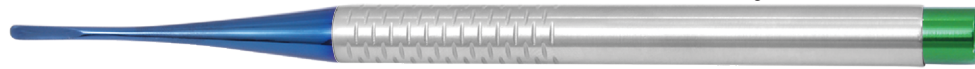

SF-7-5349 2.5 mm Micro Edge, Straight



SF-7-5350 2.5 mm Micro Edge, Curved



SF-7-5351 3.4 mm Straight

SF-7-5352 Set Of 7 Pieces



SF-7-5353 Distal, 2.5 mm Micro Edge

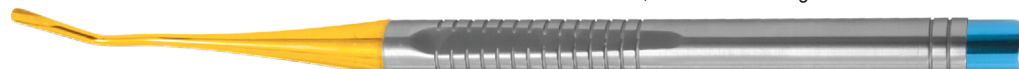

SF-7-5354 Mesial, 2.5 mm Micro Edge



SF-7-5355 Distal, 4 mm Micro Edge



SF-7-5356 Mesial 4 mm Micro Edge



SF-7-5357 2.5 mm Micro Edge, Straight



SF-7-5358 2.5 mm Micro Edge, Curved



SF-7-5359 3.4 mm Straight

SF-7-5360 Set Of 7 Pieces



Instruments Tray

Trephine Drills



SF-7-5361
Interior 2 mm
Exterior 3 mm



SF-7-5362
Interior 3 mm
Exterior 4 mm



SF-7-5363
Interior 4 mm
Exterior 5 mm



SF-7-5364
Interior 5 mm
Exterior 6 mm



SF-7-5365
Interior 6 mm
Exterior 7 mm



SF-7-5366
Interior 7 mm
Exterior 8 mm



SF-7-5367
Interior 8 mm
Exterior 9 mm



SF-7-5368
Interior 9 mm
Exterior 10 mm

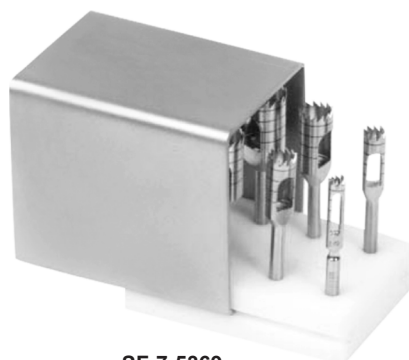

SF-7-5369
Trephine Drills Stand
Complete with drills



SF-7-5370
Trephine Drills Stand
Complete with drills

Tissue Punches



SF-7-5371
2 mm

SF-7-5372
3 mm

SF-7-5373
4 mm

SF-7-5374
5 mm

SF-7-5375
6 mm

SF-7-5376
7 mm

SF-7-5377
8 mm

Keyes



SF-7-5378
3 mm

SF-7-5379
4 mm

SF-7-5380
5 mm

SF-7-5381
6 mm

Keyes

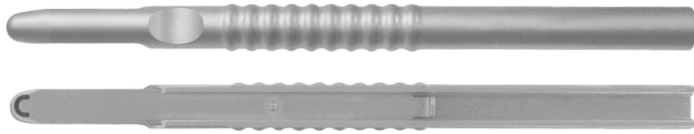

SF-7-5382
Bone Collector Chisel Straight



SF-7-5383
Blade for Straight bone collector chisel



SF-7-5384
Bone Collector Chisel Curved



SF-7-5385
Blade for Curved bone collector chisel



SF-7-5386
Ratchet Screw driver handle
Hexagonal head



SF-7-5387
Bone Morselizer with Titanium Grinding



SF-7-5388
Bone Mixing Basin
Dia 35 mm



SF-7-5389
Manual Easy Bone Mill



SF-7-5390
Bone Craker Titanium



Surgiforce Instruments



Opposite Surgical Association,
Malkay Kalan, Marala Road,
Sialkot-51050 Pakistan.



+92 523 559131



info@surgiforce.com
sales@surgiforce.com



www.surgiforce.com



Our Certifications:

ISO 9001

CE Certified

EN 13485:2012

ISO 7153-1

ISO 7151

ISO 17664:2004

ISO 13402

ISO 15223

