

# Surgiforce Instruments

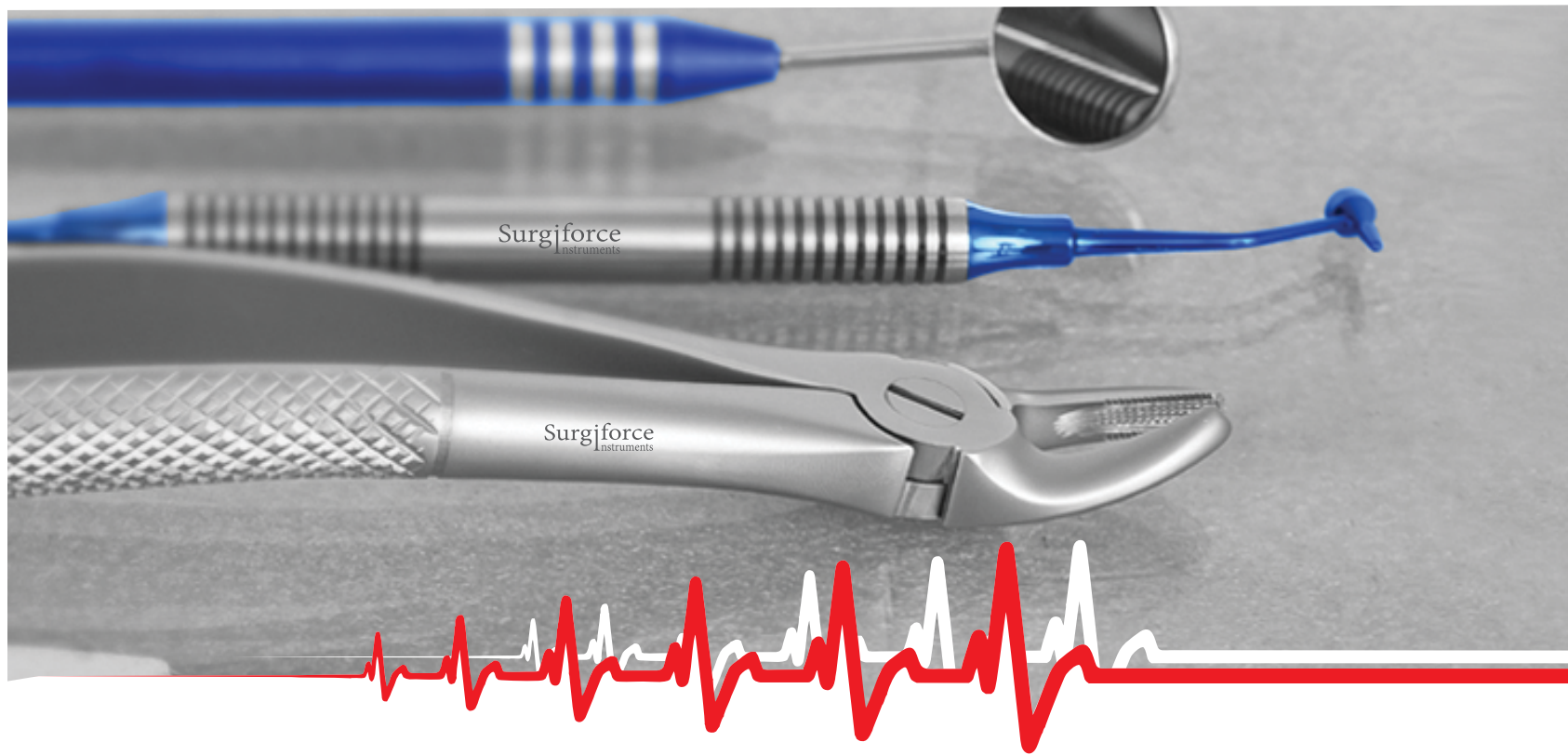

## DENTAL instruments Catalogue

[www.surgiforce.com](http://www.surgiforce.com)

# Company Profile

We at **SURGIFORCE INSTRUMENTS** welcome you to the world of reliable quality in the products where it matters the most, to the world of precision, where lack of it could be a matter of life and death.

**SURGIFORCE INSTRUMENTS** is an industry leader in manufacturing and providing worldwide solutions for SURGICAL / DENTAL / DIAGNOSTIC & HOLLOW WARE instruments.

Our Professionals continually strive to satisfy your technical and clinical needs of surgical instruments. We maintain a team work environment throughout the company by placing experienced members on critical manufacturing processes in instrument craftsmanship with state-of-the-art precision manufacturing equipments and the latest technologies to achieve the highest possible results.

Our instruments range from precision micro handheld surgical instruments(including forceps, clamps, scissors, needle holders, cutting and clamping devices) used in general surgery, ophthalmic, neurosurgical, ENT and cardiovascular specialties to macro instruments used in spinal, orthopedic and other surgical areas.

**SURGIFORCE INSTRUMENTS** holds worldwide recognized certifications such as:

ISO 9001

CE Certified

EN 13485:2012

ISO 7153-1

ISO 7151

ISO 17664:2004

ISO 13402

ISO 15223



Which ensures our clientage that they are in best hands when it comes to quality of the instruments as well as their compliance with the international standards.

Our Quality policy ensures that every instrument is manufactured to its highest quality by maintaining quality checks at every stage, as it is our belief that our success depends on establishing enduring relationships with our customers and consistently producing high quality products that meet their demanding standards and timetables.

---

## Production View



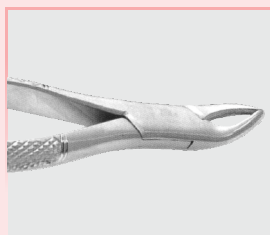

01

Extracting Forceps

Page 01-31



02

Root Elevators

Page 32-50

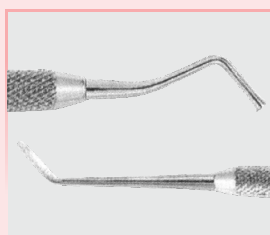

03

Filling Instruments

Page 51-55

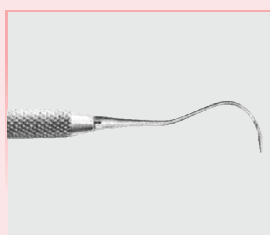

04

Dental Probes

Page 56-59

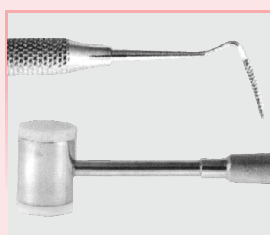

05

Periodontia Instruments  
Mallets

Page 60-67

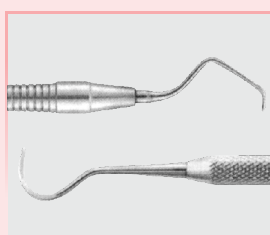



06

Curettes  
Scalers

Page 68-74

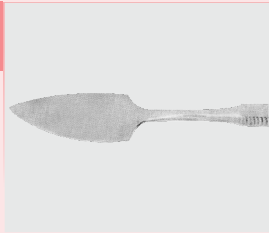
## TABLE OF CONTENTS

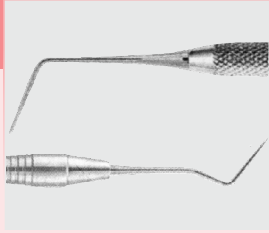
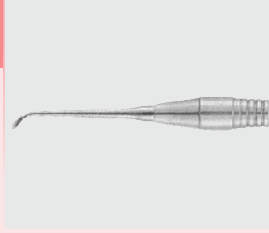
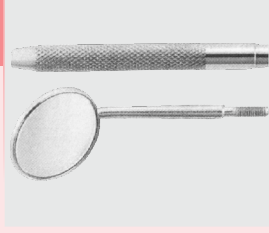
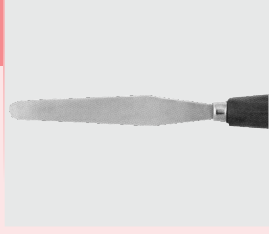
Page 75-77	Modelling Instruments Measuring Instruments	07	
Page 78-79	Wax / Plaster Knives	08	
Page 80-85	Diagnostic (Explorers) Endodontic Instruments	09	
Page 86-87	Excavators	10	
Page 88-89	Handles For Mouth Mirrors Mouth Mirrors	11	
Page 90-93	Spatulas	12	

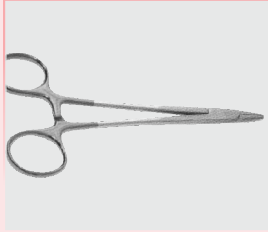

13

Needle Holders &  
Saliva Ejectors

Page 94-100

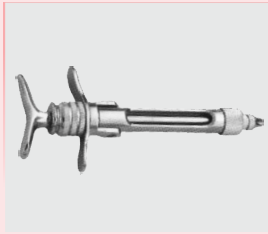

14

Syringes & Scissors

Page 101-109



15

Dental Tweezers

Page 110-114

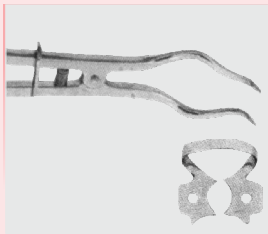

16

Rubber Dam Clamps

Page 115-117

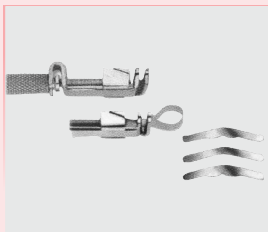

17

Matrix Retainers &  
Matrix Bands

Page 118-119

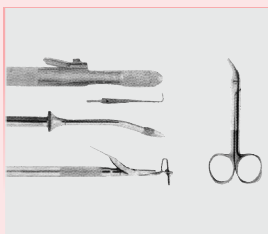



18

Crown Removers, Scissors,  
Forceps, Amalgam Guns & Carriers

Page 120-122

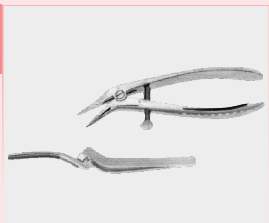
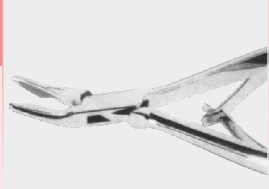
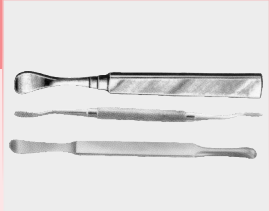
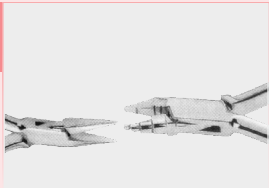
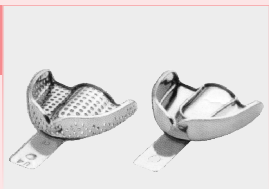
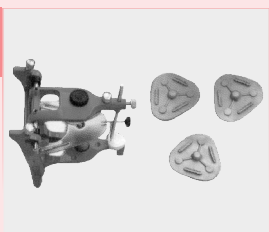
## TABLE OF CONTENTS

Page 123	Copper Ring Removing Pliers & Paper Articulating Forceps	19	
Page 124-127	Rongeurs	20	
Page 128-129	Bone Elevators, Files & Chisels	21	
Page 130-151	Pliers For Orthodontics, Mouth Gags, Tongue Depressors Lip and Cheek Retractors and Implantology Instruments	22	
Page 152-155	Impression Trays	23	
Page 156-157	Articulators	24	
Page 158-160	Hollowares	25	

Page  
1-31

- Extracting Forceps - English Pattern

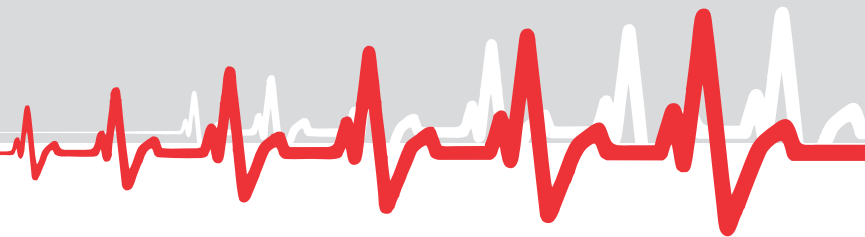



**SF-1-5101**  
Fig 8  
lower premolars



**SF-1-5102**  
Fig 13  
lower premolars



**SF-1-5103**  
Fig 17  
upper molars, right

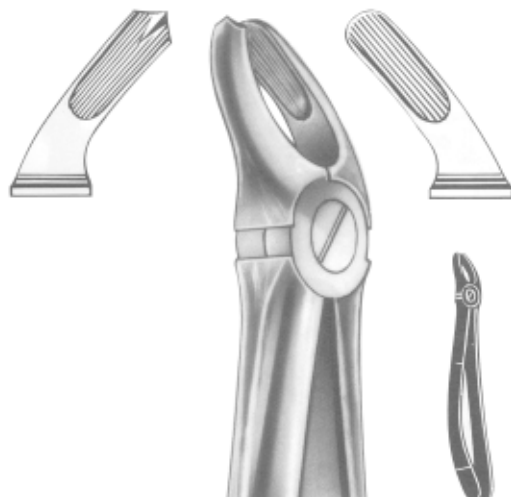
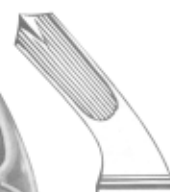

**SF-1-5104**  
Fig 18  
upper molars, left

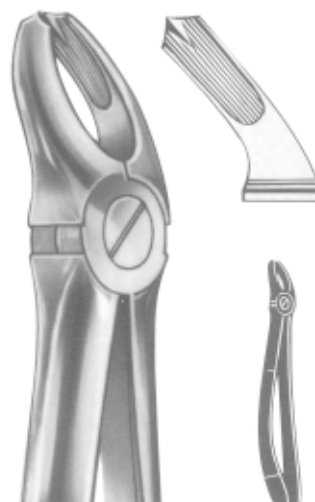

**SF-1-5105**  
Fig 18 A  
upper molars





**SF-1-5106**  
Fig 19  
upper wisdoms

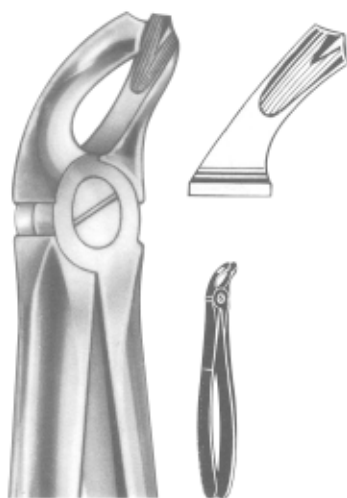

**SF-1-5107**  
Fig 20  
lower wisdoms

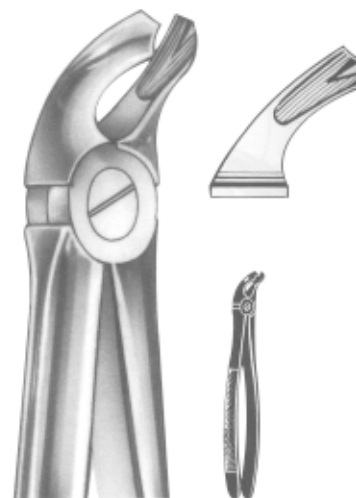

**SF-1-5108**  
Fig 21  
lower molars



**SF-1-5109**  
Fig 22  
lower molars

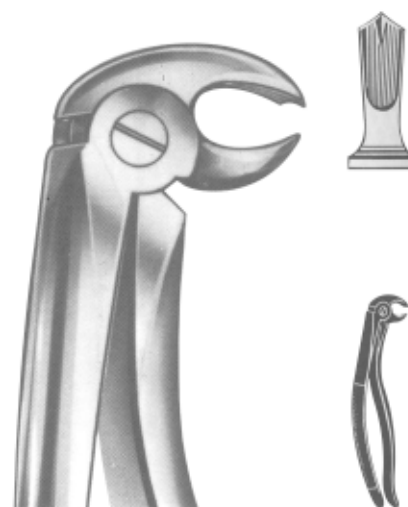

**SF-1-5110**  
Fig 22 A  
Albrecht  
lower molars



**SF-1-5111**  
Fig 33 A  
lower roots



**SF-1-5112**  
Fig 33 B  
lower roots



**SF-1-5113**  
Fig 33 L  
lower roots



**SF-1-5114**  
Fig 33 L  
lower roots



**SF-1-5115**  
Fig 33 S  
lower roots, for children



**SF-1-5116**  
Fig 44  
upper roots

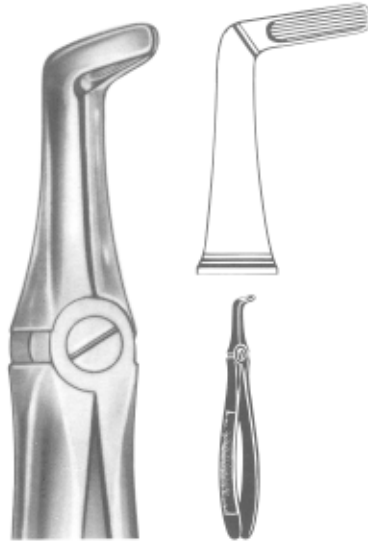

**SF-1-5117**  
Fig 45  
lower roots

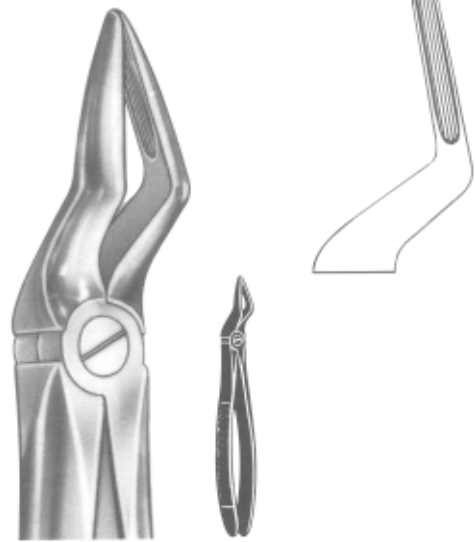

**SF-1-5118**  
Fig 12  
upper roots

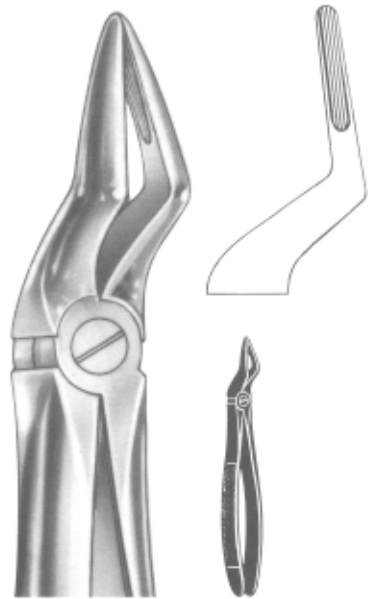

**SF-1-5119**  
Fig 51 A  
upper roots

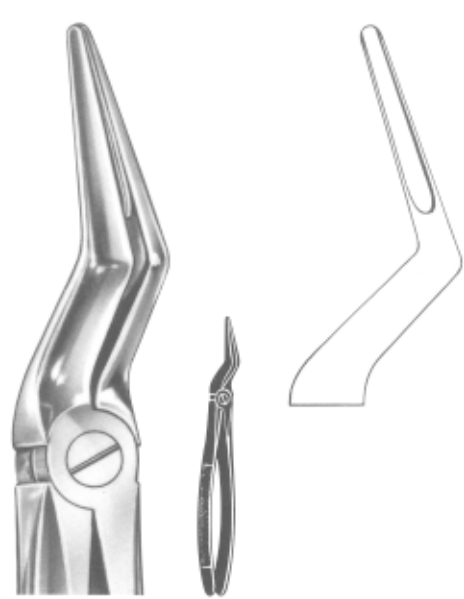

**SF-1-5120**  
Fig 51 L  
upper roots



**Relax**  
**SF-1-5121**  
Fig 51  
upper roots

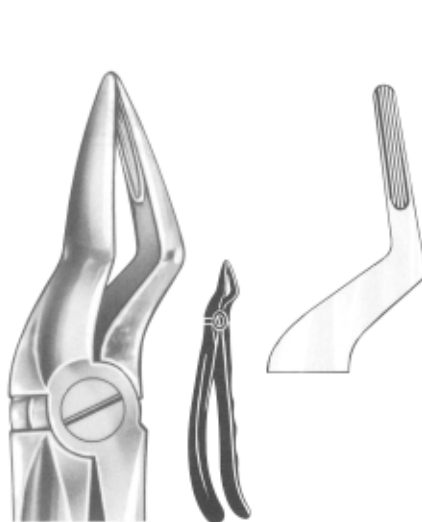

**Relax**  
**SF-1-5122**  
Fig 51 A  
upper roots

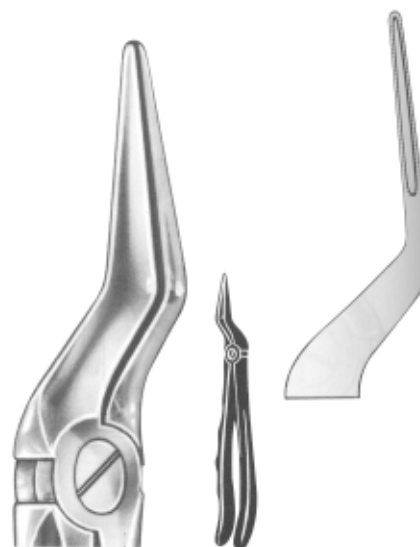

**Relax**  
**SF-1-5123**  
Fig 51 L  
upper roots

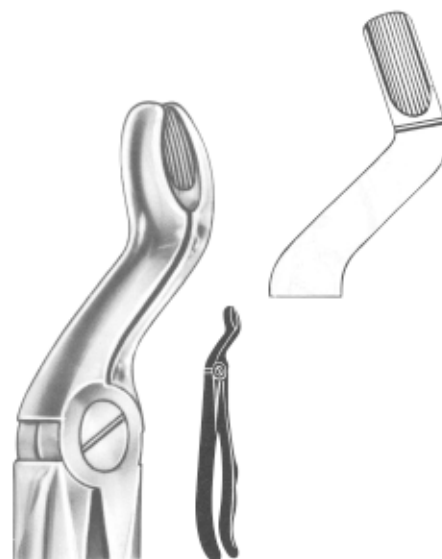

**Relax**  
**SF-1-5124**  
Fig 67  
upper wisdoms

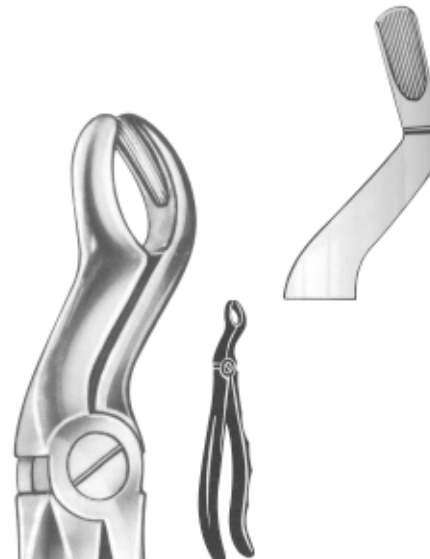

**Relax**  
**SF-1-5125**  
Fig 67 A  
upper wisdoms

# Extracting Forceps For Children - English Pattern

[www.surgiforce.com](http://www.surgiforce.com)



**SF-1-5126**  
Fig 37  
Upper incisors

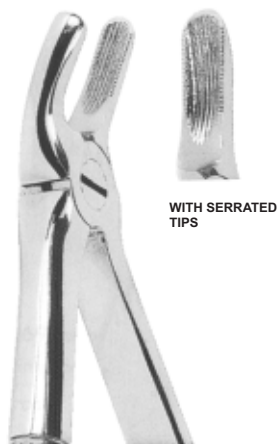

WITH SERRATED  
TIPS

**SF-1-5127**  
Fig 39  
Upper molars

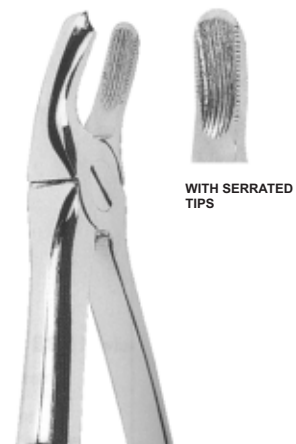

WITH SERRATED  
TIPS

**SF-1-5128**  
Fig 39 R  
Upper molars, right



WITH SERRATED  
TIPS

**SF-1-5129**  
Fig 39 L  
Upper molars, left



WITH SERRATED  
TIPS

**SF-1-5130**  
Fig 515  
Upper roots



**Klein**  
**SF-1-5132**  
Fig 137  
upper incisors



**Klein**  
**SF-1-5131**  
Fig 6  
lower molars



**Klein**  
**SF-1-5133**  
Fig 5  
lower incisors

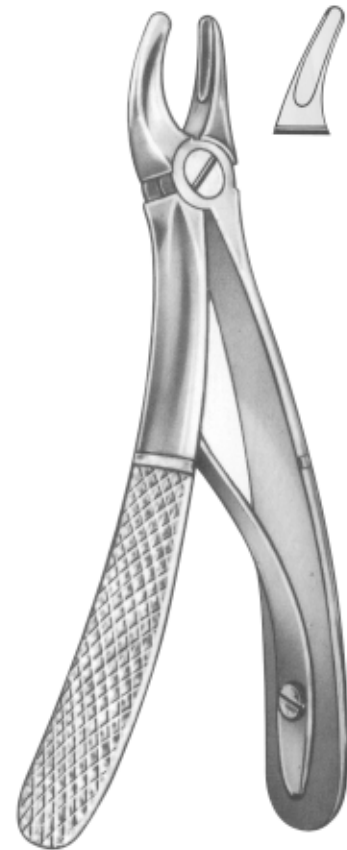

**Klein**  
**SF-1-5134**  
Fig 139  
uper premolars



**SF-1-5135**  
Fig 43 A  
Fractured or decayed  
upper teeth

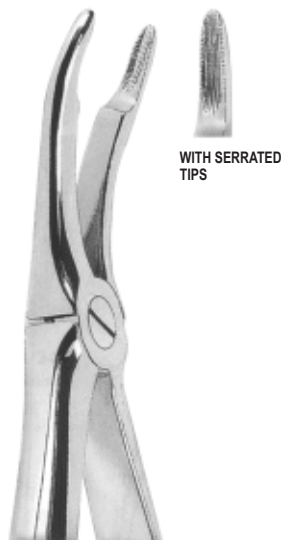

**SF-1-5136**  
Fig 44  
Upper roots



**SF-1-5137**  
Fig 45  
Lower roots

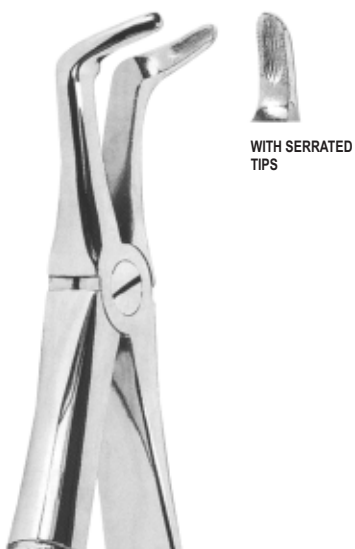

**SF-1-5138**  
Fig 46  
Lower roots

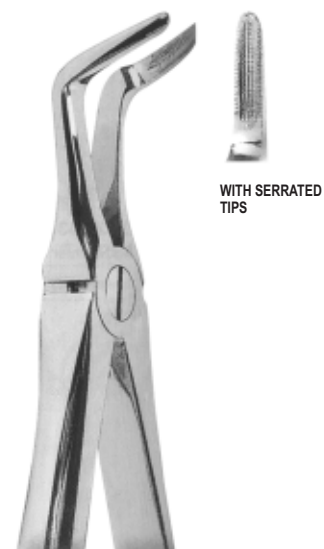

**SF-1-5139**  
Fig 46 L  
Lower roots



**SF-1-5140**  
Fig 48  
Upper roots

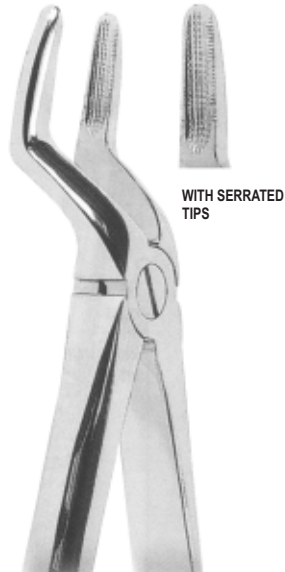

**SF-1-5141**  
Fig 51  
Upper roots

WITH SERRATED TIPS

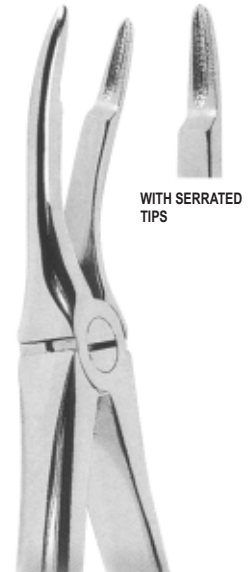

**SF-1-5142**  
Fig 49  
Upper roots

WITH SERRATED TIPS



**SF-1-5143**  
Fig 51 L  
Upper roots

WITH SERRATED TIPS



**SF-1-5144**  
Fig 51 A  
Upper roots

WITH SERRATED TIPS





**SF-1-5145**  
Fig 51 LX  
Upper roots



**1046**  
Fig 52  
Upper roots and  
canines



**SF-1-5147**  
Fig 54  
For separating  
upper molars



**SF-1-5148**  
Fig 55  
For separating  
upper molars



**SF-1-5149**  
Fig 56  
For separating  
lower molars



**SF-1-5150**  
Fig 59  
Lower roots



WITH SERRATED  
TIPS

**SF-1-5151**  
Fig 59 L  
Lower incisor  
roots

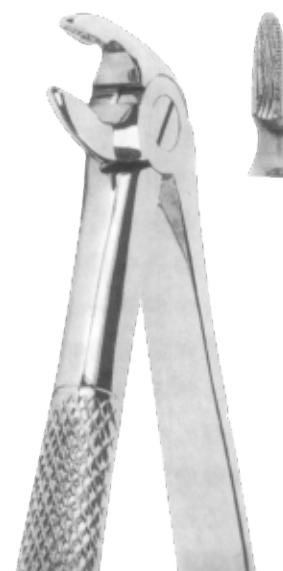

**SF-1-5152**  
Fig 60  
Lower roots



WITH SERRATED  
TIPS

**SF-1-5153**  
Fig 65 L  
Upper Molars, Left



WITH SERRATED  
TIPS

**SF-1-5154**  
Fig 65 R  
Upper Molars, right



**SF-1-5155**  
Fig 66 L  
Upper molars, left



**SF-1-5156**  
Fig 66 R  
Upper molars, right



**SF-1-5157**  
Fig 67  
Upper third molars



**SF-1-5158**  
Fig 67 A  
Upper third molars



**SF-1-5159**  
Fig 68  
Lower roots





**SF-1-5160**  
Fig 67½ L  
Upper third molars, left



**SF-1-5161**  
Fig 67½ R  
Upper third molars, right



**SF-1-5162**  
Fig 73  
Lower molars



**SF-1-5163**  
Fig 74  
Lower roots



**SF-1-5164**  
Fig 74 M  
Lower roots



**SF-1-515**  
Fig 74 N  
Lower roots



**SF-1-5166**  
Fig 75  
Lower canines and  
premolars

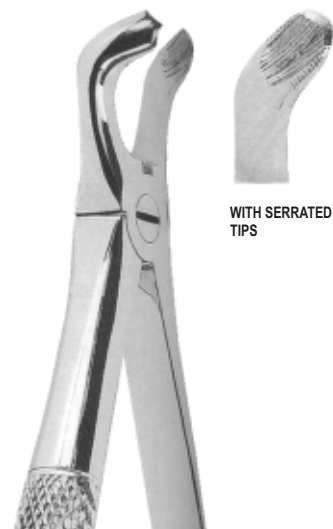

**SF-1-5167**  
Fig 79  
Lower third molars

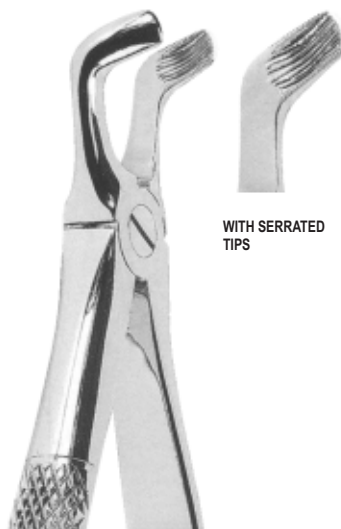

**SF-1-5168**  
Fig 79 A  
Lower third molars

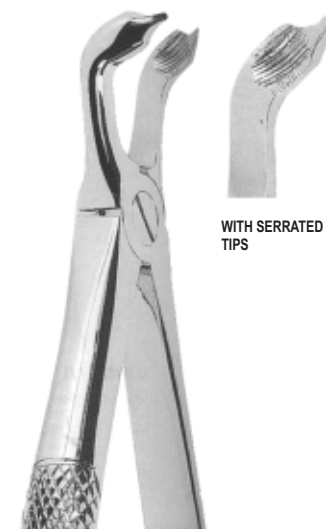

**SF-1-5169**  
Fig 79 C  
Lower third molars



**SF-1-5170**  
Fig 86 W  
Lower third molars



**SF-1-5171**  
Fig 86 1/2 L  
Lower third molars, left



**SF-1-5172**  
Fig 86 1/2 R  
Lower third molars, right



**SF-1-5173**  
Fig 86 C  
Lower molars



**SF-1-5174**  
Fig 87  
Lower decayed molars  
or broken-down crowns



WITH SERRATED  
TIPS

**SF-1-5175**  
Fig 89  
Upper molars, right



WITH SERRATED  
TIPS

**SF-1-5176**  
Fig 90  
Upper molars, left

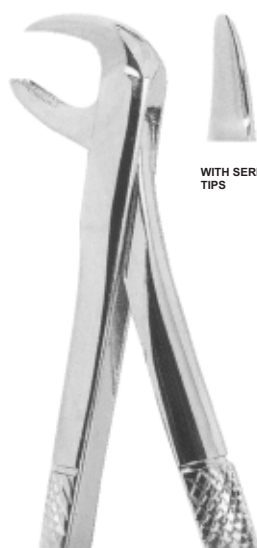

WITH SERRATED  
TIPS

**SF-1-5177**  
Fig 99  
Broken-down lower molars

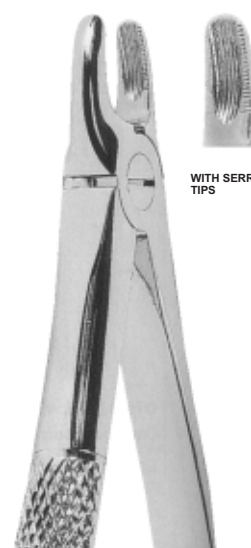

WITH SERRATED  
TIPS

**SF-1-5178**  
Fig 107  
Upper canines





**SF-1-5179**  
Fig 121  
Upper third molars



**SF-1-5180**  
Fig 145  
Lower roots



**SF-1-5181**  
Fig 151½  
Upper roots

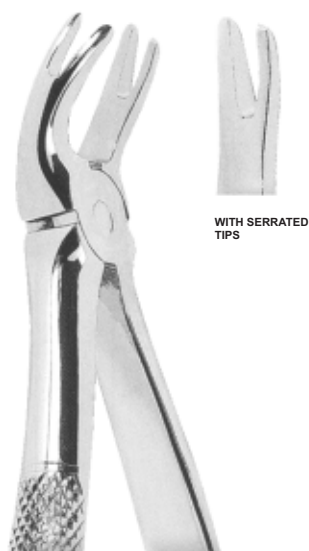

**SF-1-5182**  
Fig 166  
Universal extracting forceps for  
upper teeth, in particular molars  
and premolars



**SF-1-5183**  
Fig 167  
Universal extracting forceps for  
lower teeth, in particular molars  
and premolars



WITH SERRATED TIPS

**SF-1-5184**  
Fig 168  
Upper canines



WITH SERRATED TIPS

**SF-1-5185**  
Fig 169  
Lower canines

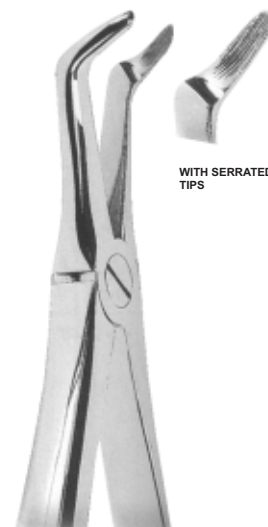

WITH SERRATED TIPS

**SF-1-5186**  
Fig 346  
Lower roots



WITH SERRATED TIPS

**SF-1-5187**  
Fig 349  
Upper roots



WITH SERRATED TIPS

**SF-1-5188**  
Fig 359  
Lower roots



**SF-1-5189**  
Fig 1  
Universal extracting forcep for  
upper incisors and canines

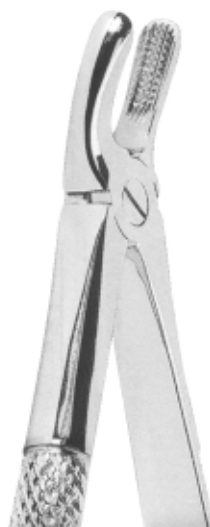

**SF-1-5190**  
Fig 2  
Upper molars



**SF-1-5191**  
Fig 3  
Lower incisors, premolar  
and roots

WITH SERRATED  
TIPS



**SF-1-5192**  
Fig 4  
Lower molars

WITH SERRATED  
TIPS

# Extracting Forceps With Anatomically Shyped Handle

[www.surgiforce.com](http://www.surgiforce.com)



**SF-1-5193**  
Fig 1  
Upper incisors  
and canines



WITH SERRATED  
TIPS



**SF-1-5194**  
Fig 2  
Upper incisors  
and canines



WITH SERRATED  
TIPS



**SF-1-5195**  
Fig 4  
Lower incisors  
and canines



WITH SERRATED  
TIPS



**SF-1-5196**  
Fig 7  
Upper premolars



WITH SERRATED  
TIPS



**SF-1-5197**  
Fig 13  
Lower premolars



WITH SERRATED  
TIPS



**SF-1-5198**  
Fig 17  
Upper molars, right



WITH SERRATED TIPS

**SF-1-5199**  
Fig 18  
Upper molars, left

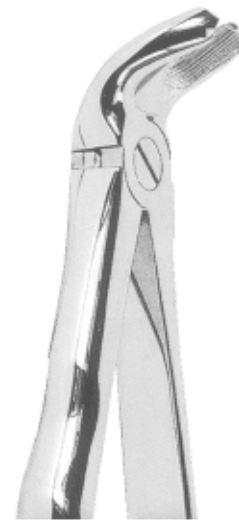

WITH SERRATED TIPS

**SF-1-5200**  
Fig 21  
Lower molars



WITH SERRATED TIPS

**SF-1-5201**  
Fig 22  
Lower molars



WITH SERRATED TIPS

**SF-1-5202**  
Fig 33  
Lower roots

# Extracting Forceps With Anatomically Shaped Handle

[www.surgiforce.com](http://www.surgiforce.com)



**SF-1-5203**  
Fig 45  
Lower roots



WITH SERRATED TIPS



**SF-1-5204**  
Fig 51 A  
Upper roots

WITH SERRATED TIPS



**SF-1-5205**  
Fig 67 A  
Upper third molars

WITH SERRATED TIPS



**SF-1-5206**  
Fig 74  
Lower roots

WITH SERRATED TIPS

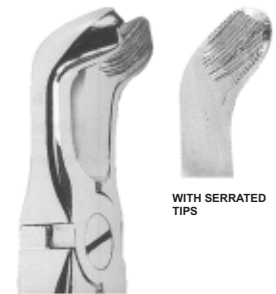

**SF-1-5207**  
Fig 79  
Lower third molars

WITH SERRATED TIPS



**SF-1-5208**  
Fig 86 C  
Lower molars

WITH SERRATED TIPS



**SF-1-5209**  
Fig 359  
Lower roots

WITH SERRATED TIPS



**SF-1-5210**  
Fig 89  
Upper molars, right



WITH SERRATED TIPS



**SF-1-5211**  
Fig 90  
Upper molars, left



WITH SERRATED TIPS



**SF-1-5212**  
Fig 145  
Lower roots



WITH SERRATED TIPS



**SF-1-5213**  
Fig 151 1/2  
Upper roots



WITH SERRATED TIPS



**SF-1-5214**  
Fig 349  
Upper roots



WITH SERRATED TIPS



**SF-1-5215**  
Fig 5  
Lower third molars



**SF-1-5216**  
Fig 6  
Separating forcep



**SF-1-5217**  
Fig 105  
Upper molars



**SF-1-5218**  
Fig 16  
Lower molars



**SF-1-5219**  
Fig 17  
Lower molars





**SF-1-5220**  
Fig 18 L  
Upper molars, left



**SF-1-5221**  
Fig 18 R  
Upper molars, right



**SF-1-5222**  
Fig 23  
Lower molars



**SF-1-5223**  
Fig 53 R  
Upper molars, right



**SF-1-5224**  
Fig 53 L  
Upper molars, left



**SF-1-5225**  
Fig 65  
Upper incisors and roots



**SF-1-5226**  
Fig 69  
Upper and lower roots



**SF-1-5227**  
Fig 88 R  
Upper molars, right



**SF-1-5228**  
Fig 88 L  
Upper molars, left



**SF-1-5229**  
Fig 101  
Deciduous teeth



**SF-1-5230**  
Fig 150  
Upper incisors, premolars, roots



**SF-1-5231**  
Fig 150 S  
Upper teeth (for children)



**SF-1-5232**  
Fig 151  
Upper incisors, premolars, roots



**SF-1-5233**  
Fig 151S  
Lower teeth (for children)



**SF-1-5234**  
Fig 222  
Lower third molars

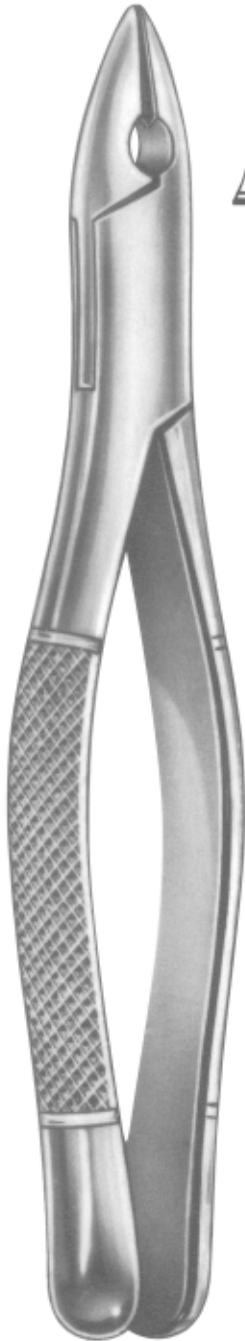

**SF-1-5235**  
Fig 1  
upper incisors and bicuspid



**SF-1-5236**  
Fig 1 B  
upper roots, anterior



**Physick**  
**SF-1-5237**  
Fig 5  
lower wisdoms



**SF-1-5238**  
Fig 6  
lower molars, splitting forceps



**SF-1-5239**  
Fig 10 H  
upper molars





**SF-1-5240**  
Fig 135  
Lower premolars



WITH SERRATED TIPS



**SF-1-5241**  
Fig 225  
Lower molars

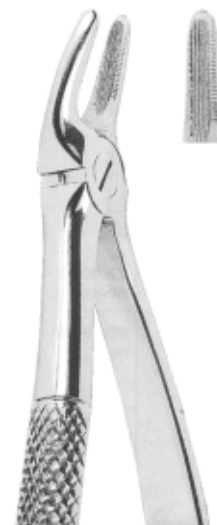

**SF-1-5242**  
Fig 305  
Upper incisors  
and roots



**SF-1-5243**  
Fig 33 S  
Lower roots



WITH SERRATED TIPS



**SF-1-5244**  
Fig 38  
Lower incisors  
and canines



WITH SERRATED TIPS

# Extracting Forceps For Children - Klein Pattern

[www.surgiforce.com](http://www.surgiforce.com)



**SF-1-5245**  
Fig 1  
Upper incisors



**SF-1-5246**  
Fig 2  
Upper permolars



**SF-1-5247**  
Fig 3  
Upper molars



**SF-1-5248**  
Fig 4  
Upper roots



**SF-1-5249**  
Fig 5  
Lower incisors



**SF-1-5250**  
Fig 6  
Lower molars



**SF-1-5251**  
Fig 7  
Lower roots



**SF-1-5252**  
Fig 1  
Lower roots



**SF-1-5253**  
Fig 2  
Upper roots



**SF-1-5255**  
Fig 2  
Roots fragments



**SF-1-5254**  
Fig 1  
Roots fragments

Page  
32–50

- Root Elevators

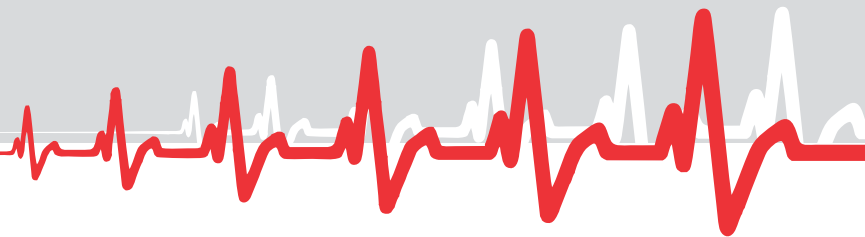



lower jaw, left side

lower jaw, right side

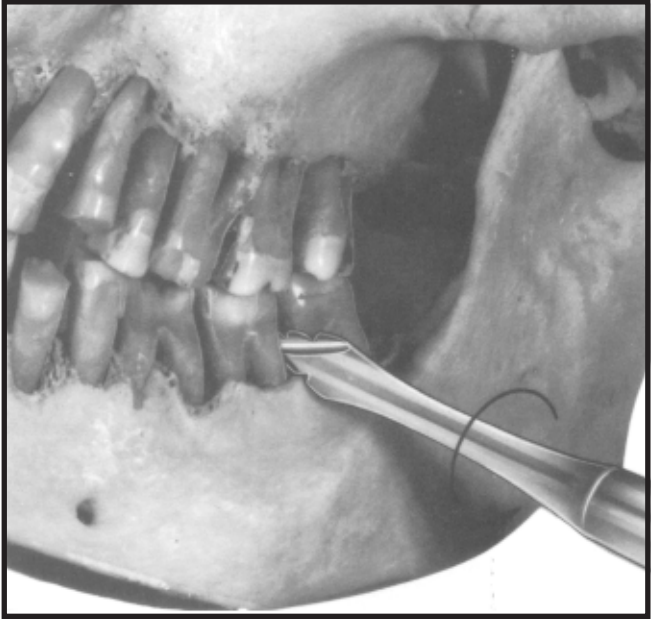

SF-2-5101



SF-2-5102

Root elevator, spiral-shaped, for extremely facilitated extraction of the molars in the lower jaw. The slender, conical points allow deep penetration between tooth and gum. Owing to the hook-shaped working parts, slipping of the elevator is avoided.



Bein



**Bein  
SF-2-5103**  
Fig 1



**Bein  
SF-2-5104**  
Fig 2

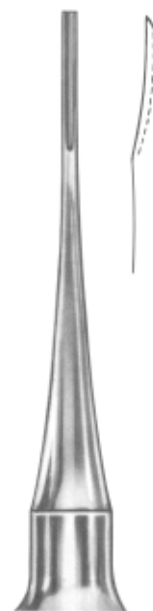

**Bein  
SF-2-5105**  
Fig 0



**Bein  
SF-2-5106**  
Fig 3

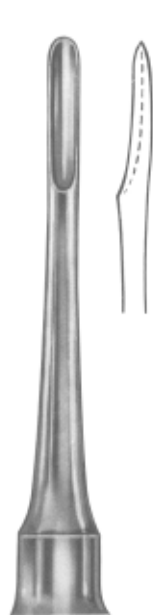

**Bein  
SF-2-5107**  
Fig 4



**Bein  
SF-2-5108**  
Fig 5



**Bein  
SF-2-5109**  
Fig 6



Seldin



Seldin  
SF-2-5110  
Fig 1L



Seldin  
SF-2-5111  
Fig 1R



Seldin  
SF-2-5112  
Fig 2



Seldin  
SF-2-5113  
Fig 3



Seldin  
SF-2-5114  
Fig 4L



Seldin  
SF-2-5115  
Fig 4R



**Cryer  
SF-2-5116  
Fig 3**



**Cryer  
SF-2-5117  
Fig 4**



**Cryer  
SF-2-5118  
Fig 12**



**Cryer  
SF-2-5119  
Fig 27**



**Cryer  
SF-2-5120  
Fig 28**



**Cryer  
SF-2-5121  
Fig 27 S**



**Cryer  
SF-2-5122  
Fig 28 S**



Apical



Apical  
SF-2-5123  
Fig 1



Apical  
SF-2-5124  
Fig 2



Apical  
SF-2-5125  
Fig 3



Apical  
SF-2-5126  
Fig 4



**Cryer**



**Cryer  
SF-2-5127  
Fig 1**

**Cryer  
SF-2-5128  
Fig 2**



**Coupland**



**Coupland  
SF-2-5129  
Fig 1**

**Coupland  
SF-2-5130  
Fig 2**

**Coupland  
SF-2-5131  
Fig 3**



SF-2-5132  
Fig 1

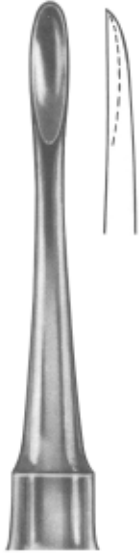

SF-2-5133  
Fig 2



SF-2-5134  
Fig 3



Flohr  
SF-2-5135  
Fig 1



Flohr  
SF-2-5136  
Fig 2



Flohr  
SF-2-5137  
Fig 3



**Kopp**  
SF-2-5138  
Fig 1



**Kopp**  
SF-2-5139  
Fig 2



**Kopp**  
SF-2-5144  
Fig 1



**Kopp**  
SF-2-5145  
Fig 2



**Kopp**



**Kopp**  
SF-2-5140  
Fig 3



**Kopp**  
SF-2-5141  
Fig 4



**Kopp**



**Kopp**  
SF-2-5146  
Fig 3



**Kopp**  
SF-2-5147  
Fig 4



**Kopp**  
SF-2-5142  
Fig 5



**Kopp**  
SF-2-5143  
Fig 6





**Hylin**  
**SF-2-5148**  
Fig 1

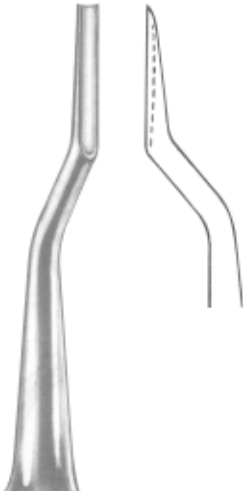

**Bein**  
**SF-2-5150**  
Fig 1

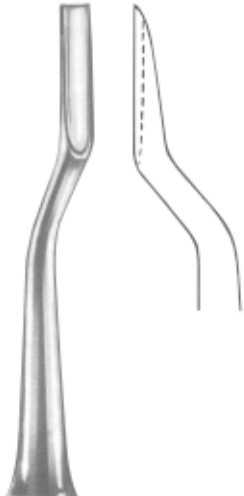

**Bein**  
**SF-2-5151**  
Fig 2



**Hylin**



**Hylin**  
**SF-2-5149**  
Fig 2



**Bein**

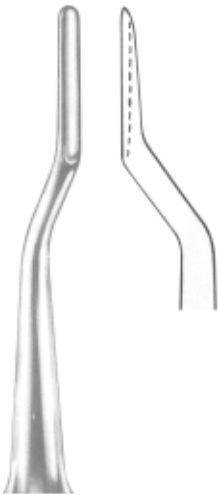

**Bein**  
**SF-2-5152**  
Fig 3

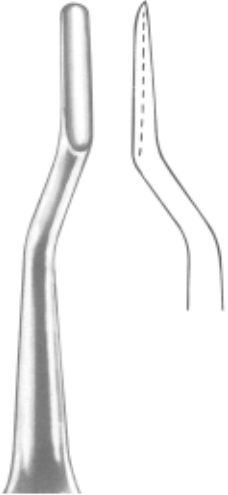

**Bein**  
**SF-2-5153**  
Fig 4



**Warwick-James  
SF-2-5154  
Fig 1**



**Warwick-James  
SF-2-5155  
Fig 2**



**Warwick-James  
SF-2-5156  
Fig 3**

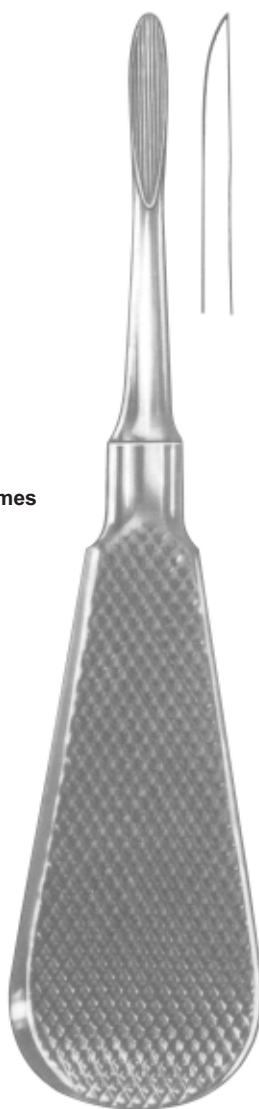

**London Hospital  
SF-2-5157  
Fig 1**



**London Hospital  
SF-2-5158  
Fig 2**



**London Hospital  
SF-2-5159  
Fig 3**



**Ott  
SF-2-5160**

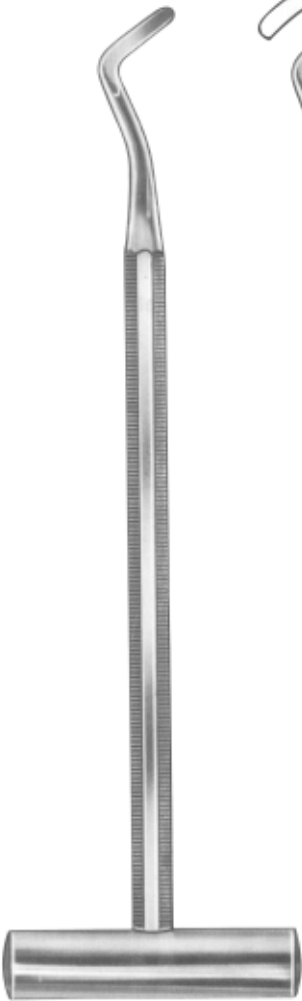

Pott



Pott  
SF-2-5162  
Fig 1



Pott  
SF-2-5163  
Fig 2



SF-2-5164  
Fig 1

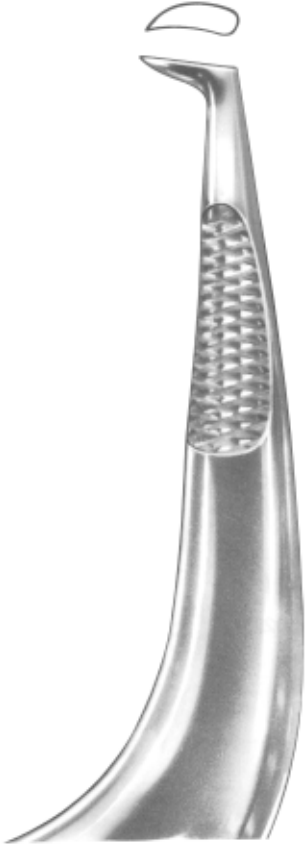

SF-2-5165  
Fig 2

# Root Elevators

[www.surgiforce.com](http://www.surgiforce.com)

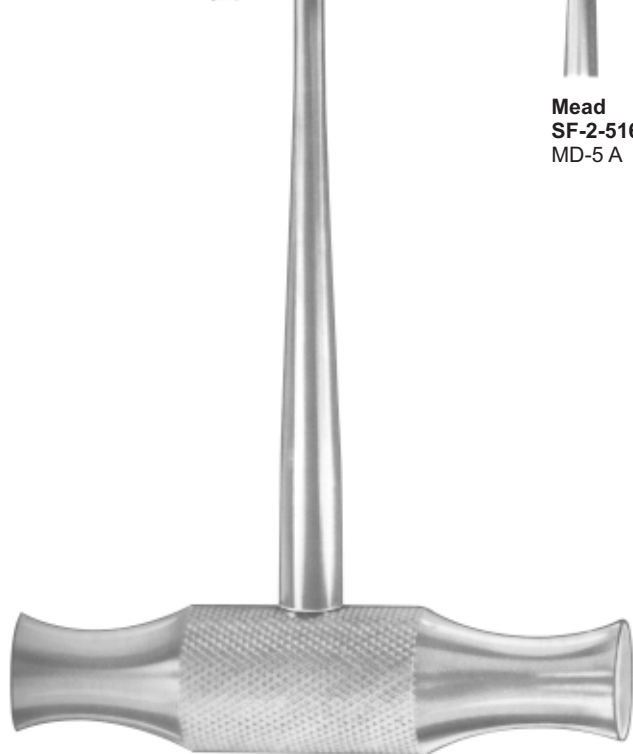

**Mead  
SF-2-5166  
MD 1**



**Mead  
SF-2-5167  
MD-5 A**



**Mead  
SF-2-5168  
MD-6 A**



**Mead  
SF-2-5169  
MD-7 A**



**Mead  
SF-2-5170  
MD-8**

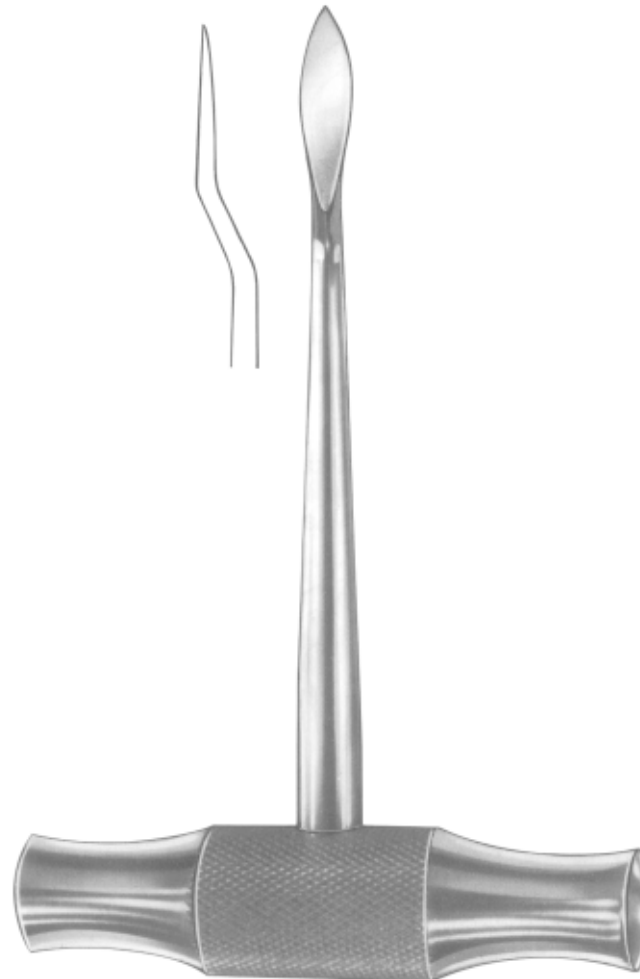

**Lecluse  
SF-2-5171**



**Chompret  
SF-2-5172  
Fig 1**



**Chompret  
SF-2-5173  
Fig 2**



**Chompret  
SF-2-5174  
Fig 3**



**Chompret  
SF-2-5175  
Fig 4**



**Apical  
SF-2-5176**



**SF-2-5177**  
Fig 1



**SF-2-5178**  
Fig 2



**SF-2-5179**  
Fig 3



**Heidbrink  
SF-2-5180**  
Fig 1



**Heidbrink  
SF-2-5181**  
Fig 2



**Heidbrink  
SF-2-5182**  
Fig 3



Winter  
SF-2-5183  
Fig 1L



Winter  
SF-2-5184  
Fig 1R



Winter  
SF-2-5185  
Fig 2L



Winter  
SF-2-5186  
Fig 2R



Winter



Winter  
SF-2-5187  
Fig 11 L



Winter  
SF-2-5188  
Fig 11 R



Winter  
SF-2-5189  
Fig 12 L



Winter  
SF-2-5190  
Fig 12 R



Winter  
SF-2-5191  
Fig 14 L



Winter  
SF-2-5192  
Fig 14 R



**Barry  
SF-2-5193  
Fig 1**



**Barry  
SF-2-5194  
Fig 2**



**Barry  
SF-2-5195  
Fig 3**



**Barry  
SF-2-5196  
Fig 4**



**Barry**



**Barry  
SF-2-5197  
Fig 11**



**Barry  
SF-2-5198  
Fig 12**



**Barry  
SF-2-5199  
Fig 17**



**Barry  
SF-2-5200  
Fig 18**





Cryer  
SF-2-5201  
Fig 26



Seldin  
SF-2-5202  
Fig 27



Cryer  
SF-2-5203  
Fig 28



Cryer  
SF-2-5204  
Fig 29



Heidbrink  
SF-2-5205  
Fig 22



Heidbrink  
SF-2-5206  
Fig 23



SF-2-5207



**Kopp**  
**SF-2-5208**  
Fig 31



**Kopp**  
**SF-2-5209**  
Fig 32



**Kopp**  
**SF-2-5210**  
Fig 33



**Kopp**  
**SF-2-5211**  
Fig 34



**Kopp**  
**SF-2-5212**  
Fig 35



**Kopp**  
**SF-2-5213**  
Fig 44



**SF-2-5214**



**Heidbrink**  
**SF-2-5215**  
Fig 10



**Winter**  
**SF-2-5216**  
Fig 11



**Winter**  
**SF-2-5217**  
Fig 12



**Barry**  
**SF-2-5218**  
Fig 17



**Barry**  
**SF-2-5219**  
Fig 18



**SF-2-5220**  
Fig 20



**SF-2-5221**

Root Elevators according to Dr. Sader,  
with interchangeable working tips



SF-2-5222

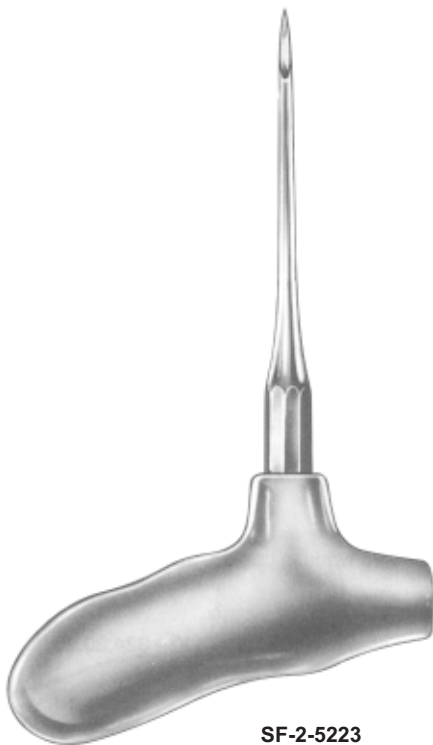

SF-2-5223



SF-2-5224

Page  
51–55

- Filling Instruments

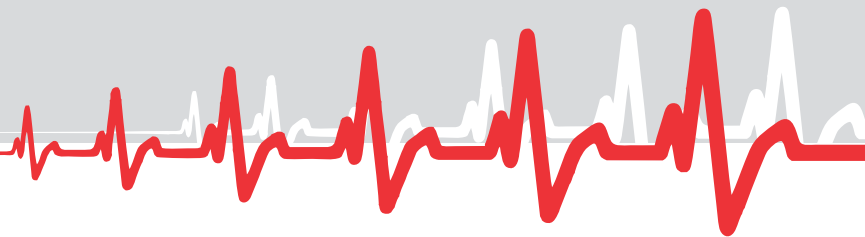



SF-2-5225  
Williams

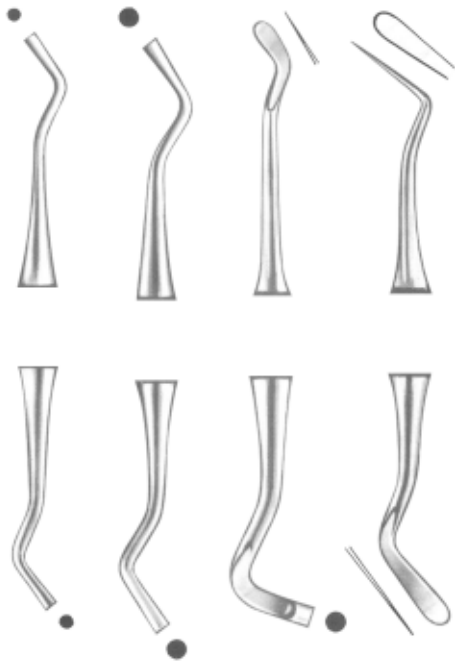

SF-2-5226 Williams  
SF-2-5227 Williams  
SF-2-5228 Williams  
SF-2-5229 Williams

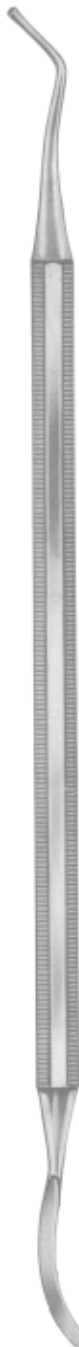

SF-2-5233  
White

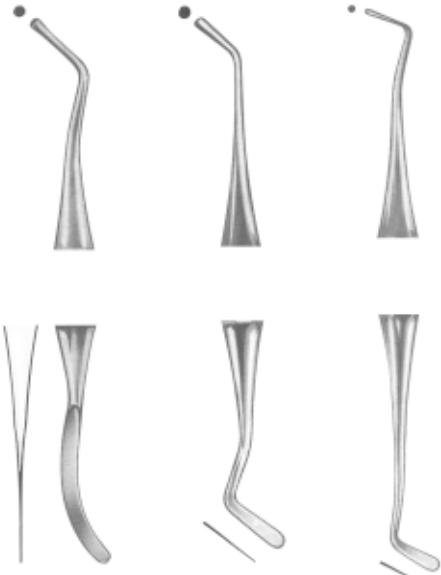

SF-2-5234 White  
SF-2-5235 White  
SF-2-5236 White

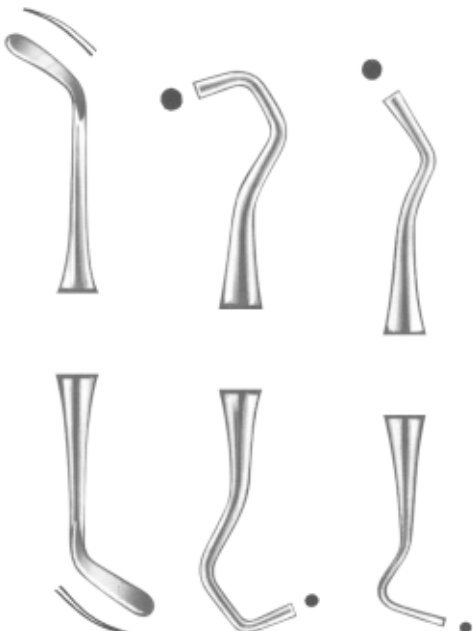

SF-2-5230 Williams  
SF-2-5231 Williams  
SF-2-5232 Williams

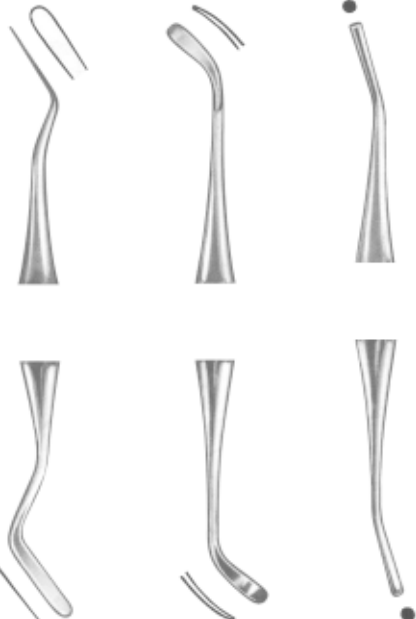

SF-2-5237 White  
SF-2-5238 White  
SF-2-5239 White

# Filling Instruments

[www.surgiforce.com](http://www.surgiforce.com)

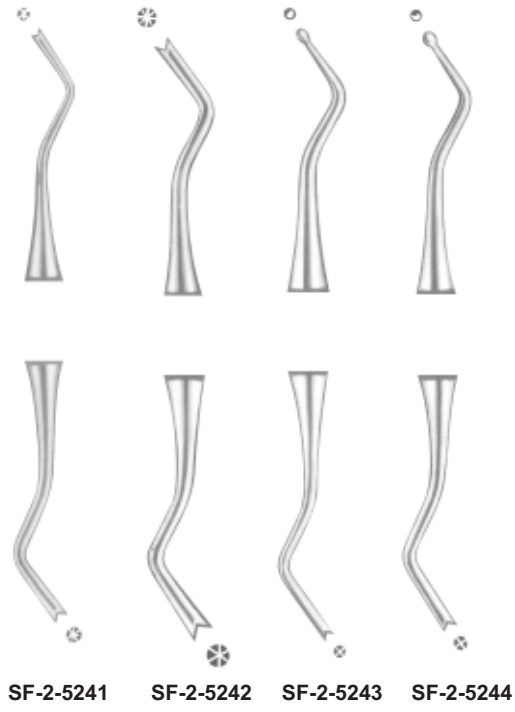
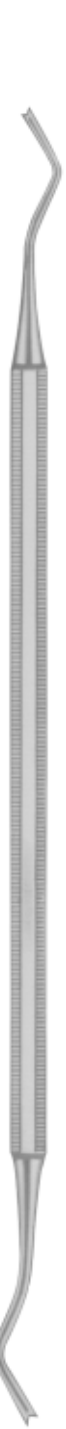

SF-2-5241 SF-2-5242 SF-2-5243 SF-2-5244

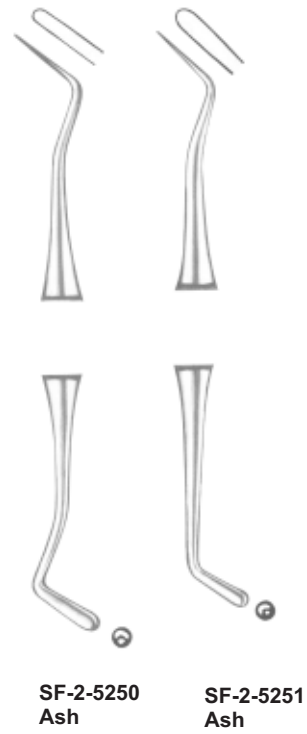
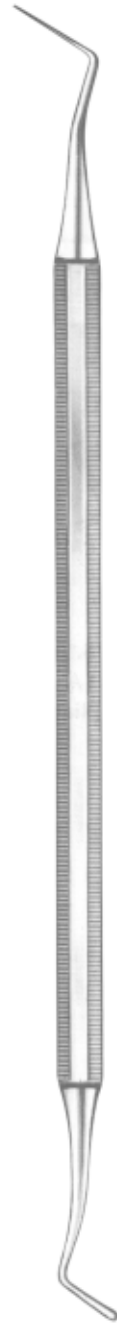

SF-2-5250 Ash SF-2-5251 Ash

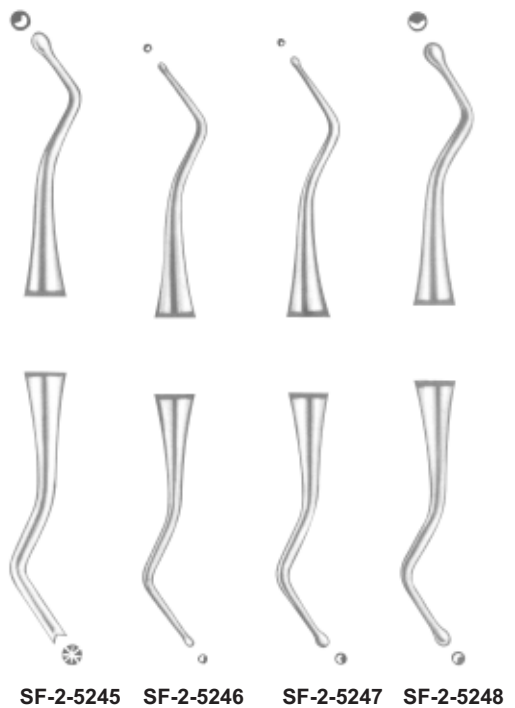

SF-2-5245 SF-2-5246 SF-2-5247 SF-2-5248

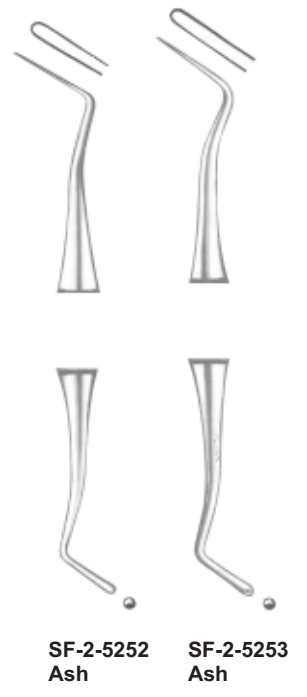

SF-2-5252 Ash SF-2-5253 Ash

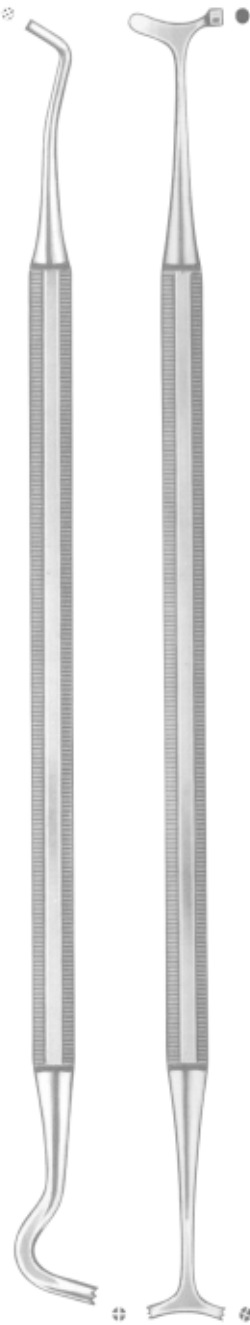

SF-2-5254 Elliott SF-2-5255 Bennett

SF-2-5240

SF-2-5249 Ash

SF-2-5254 Elliott

SF-2-5255 Bennett

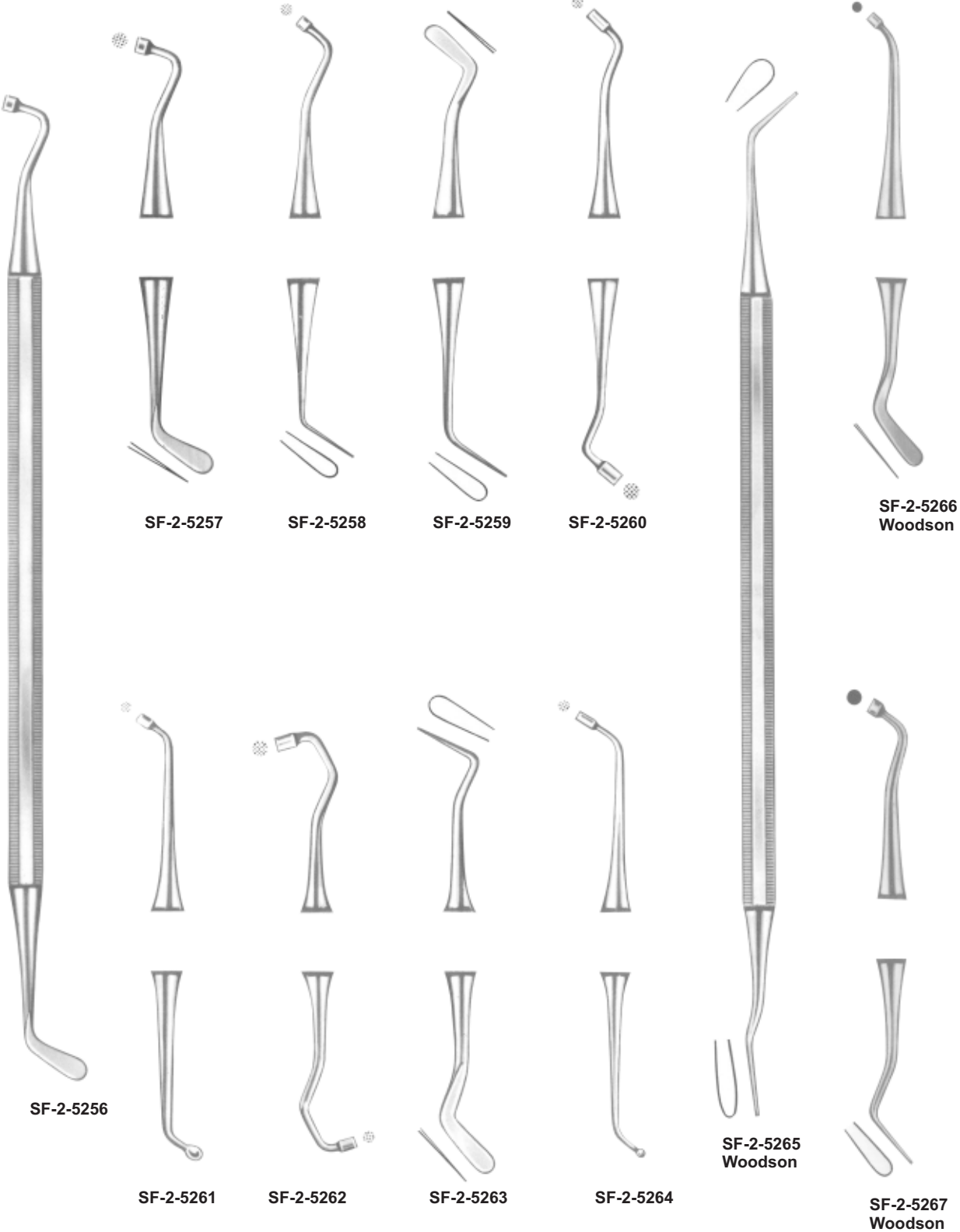



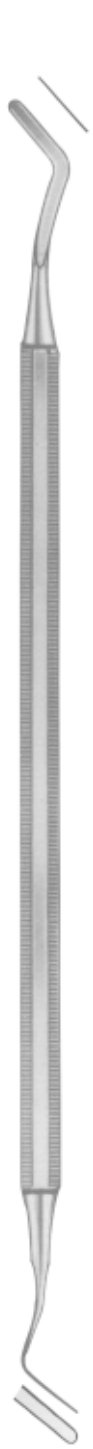

**SF-2-5268**  
Heidemann  
Fig 1



**SF-2-5269**  
Heidemann  
Fig 2



**SF-2-5271**



**SF-2-5272**  
Fig 146



**SF-2-5273**  
Fig 147

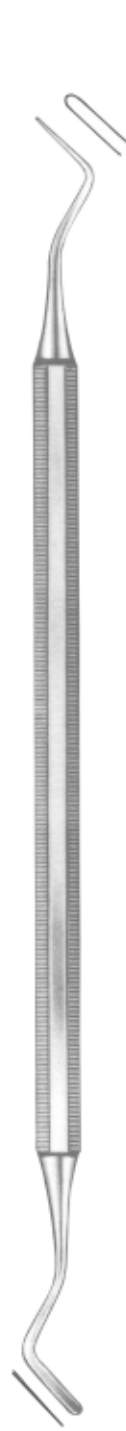

**SF-2-5276**  
Fig 158



**SF-2-5277**  
Fig 159



**SF-2-5270**  
Heidemann  
Fig 3



**SF-2-5274**  
Fig 148



**SF-2-5275**  
Fig 149

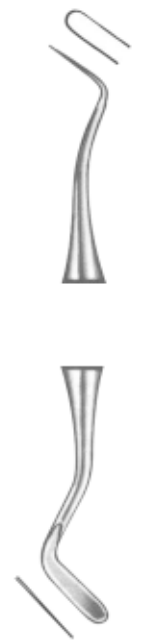

**SF-2-5278**  
Woodson  
Fig 160



**SF-2-5279**  
Gracey



**SF-2-5280**  
Gracey  
Fig 1



**SF-2-5281**  
Gracey  
Fig 2



**SF-2-5282**  
Gracey  
Fig 3



**SF-2-5283**  
Gracey  
Fig 4



**SF-2-5284**  
Gracey  
Fig 5



**SF-2-5285**  
Gracey  
Fig 6



**SF-2-5286**



**SF-2-5287**  
Fig 18



**SF-2-5288**  
Fig 19



**SF-2-5289**  
Fig 20



**SF-2-5290**  
Fig 22



**SF-2-5291**  
Fig 23



**SF-2-5292**  
Fig 25



**SF-2-5293**  
Fig 26



**SF-2-5294**  
Fig 27



Page  
56–59

- Dental Probes

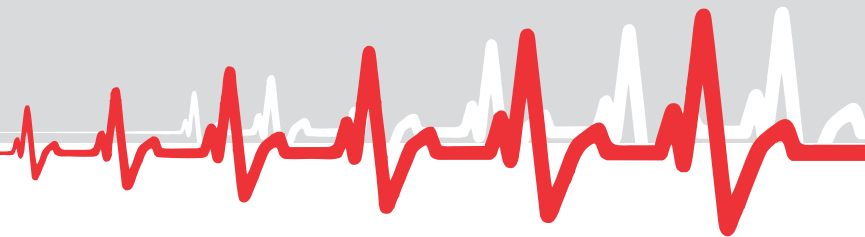

With Point Set In



SF-2-5295



SF-2-5296



SF-2-5297



SF-2-5298



SF-2-5299



SF-2-5300



SF-2-5301



SF-2-5302



SF-2-5303



SF-2-5304



SF-2-5305



SF-2-5306



SF-2-5307  
Woodson

**Polishing Instruments**

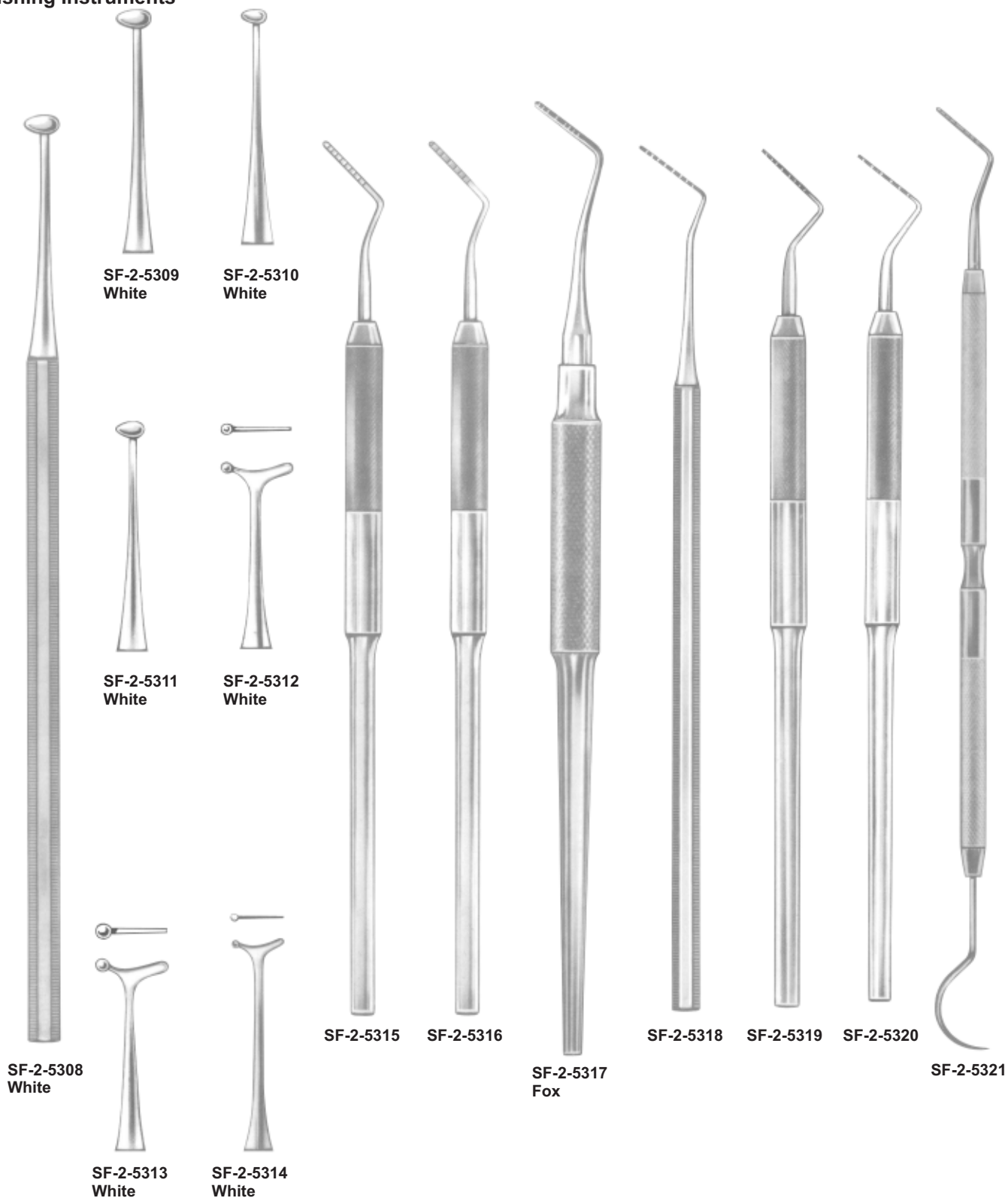

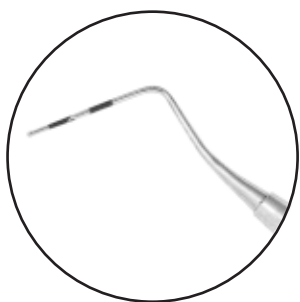

- New marking process.
- Laser system marking.
- No more paint peeling off.
- Permanent marking.
- Antiglare, low depth marking.
- Maximum tip resistance against breaking.



**SF-2-5322**  
Fig CP-C



**SF-2-5323**  
Fig CP-11



**SF-2-5324**  
Fig CP-12



**SF-2-5325**  
Fig CP-12S  
O.M.S

10-9-8-7-5-3-2-1



**SF-2-5326**  
Williams

10-9-8-7-5-3-2-1



**SF-2-5327**  
Merrit A

10-9-8-7-5-3-2-1



**SF-2-5328**  
Merrit B

10-9-8-7-5-3-2-1



**SF-2-5329**  
Goldman  
Fox

8-6-3



**SF-2-5330**  
University of  
Michigan

10-9-8-5-3-2-1



**SF-2-5331**  
26 G

Page  
60–67

- Periodontia Instruments, Mallets

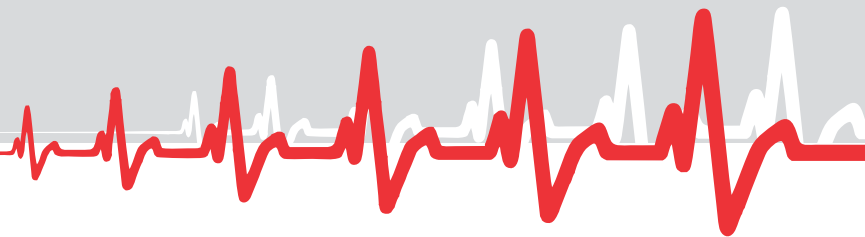



**Files**

**Chisels**



**SF-3-5101**  
Sugarman  
Fig. 1S/2S



**SF-3-5102**  
Sugarman  
Fig. 3S/4S



**SF-3-5103**  
Schluger  
Fig. 9/10



**SF-3-5104**  
Buck  
Fig. 11/12



**SF-3-5105**  
Ochsenbein  
Fig. 3



**SF-3-5106**  
Ochsenbein  
Fig. 4



**SF-3-5107**  
Rhodes  
Back - Action  
Fig. 36/37

Files

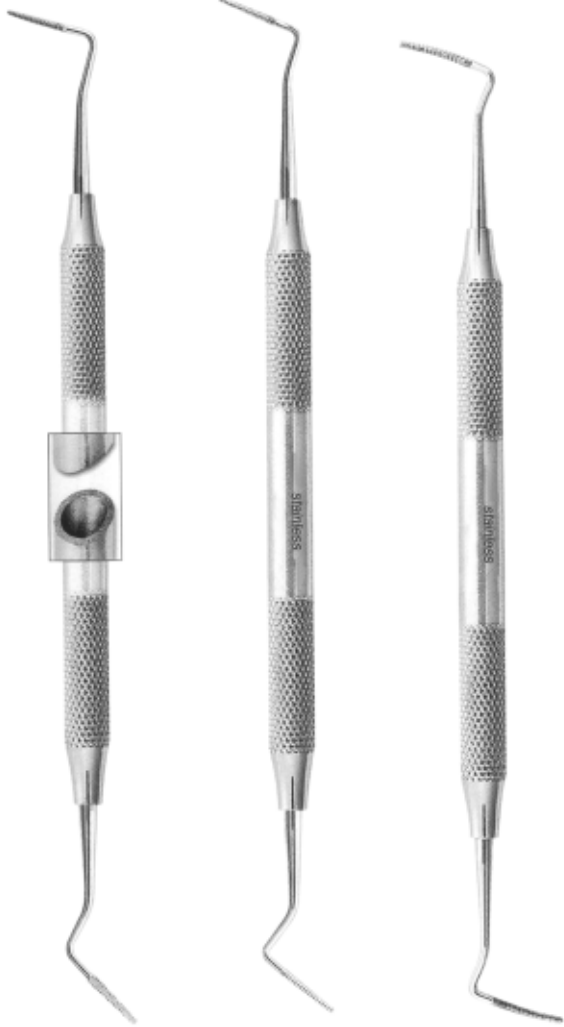

**SF-3-5108**  
Sugarman  
Fig. 1S/2S

**SF-3-5109**  
Sugarman  
Fig. 3S/4S

**SF-3-5110**  
Schluger  
Fig. 9/10



**SF-3-5111**  
Buck  
Fig. 11/12

Chisels



**SF-3-5112**  
Ochsenbein  
Fig. 3



**SF-3-5113**  
Ochsenbein  
Fig. 4



**SF-3-5114**  
Rhodes  
Back - Action  
Fig. 36/37

Gingivectomy knives



**SF-3-5115**  
Goldman-Fox  
Fig. 7



**SF-3-5116**  
Goldman-Fox  
Fig. 8



**SF-3-5117**  
Goldman-Fox  
Fig. 9



**SF-3-5118**  
Goldman-Fox  
Fig. 11



**SF-3-5119**  
Buck  
Fig. 3/4



**SF-3-5120**  
Buck  
Fig. 5/6

## Curettes and Scalers



**SF-3-5121**  
Curette  
Fig. HU 1/2



**SF-3-5122**  
Columbia  
Fig. 2R/2L



**SF-3-5123**  
Columbia  
Fig. 4R/4L



**SF-3-5124**  
Columbia  
Fig. 13/14



**SF-3-5125**  
Fig. 411/412



**SF-3-5126**  
Fig. 413/414



**SF-3-5127**  
Zerfing-chisel

Gingivectomy knives



**SF-3-5128**  
Goldman - Fox  
Fig. 7



**SF-3-5129**  
Goldman - Fox  
Fig. 8



**SF-3-5130**  
Goldman - Fox  
Fig. 9



**SF-3-5131**  
Goldman - Fox  
Fig. 11



**SF-3-5132**  
Buck  
Fig. 3/4



**SF-3-5133**  
Buck  
Fig. 5/6

## Curettes and Scalers



**SF-3-5134**  
Curette  
Fig. HU 1/2



**SF-3-5135**  
Columbia  
Fig. 2R/2L



**SF-3-5136**  
Columbia  
Fig. 4R/4L



**SF-3-5137**  
Columbia  
Fig. 13/14



**SF-3-5138**  
Fig. 413/412



**SF-3-5139**  
Fig. 411/414



**SF-3-5140**  
Zerfing-chisel

**Bone Chisels and Gouges**

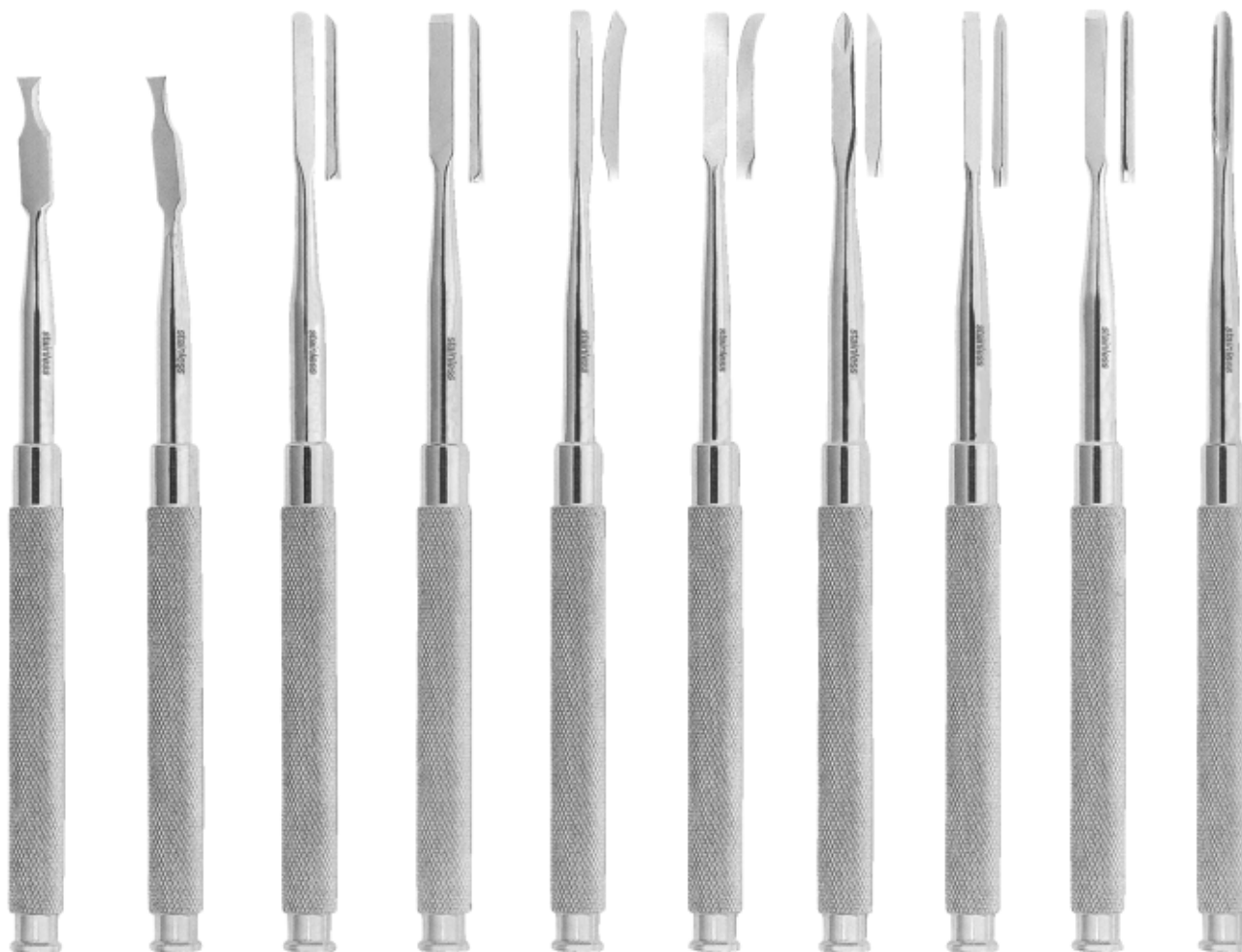

**SF-3-5141**  
Ochsenbein  
Fig. 1

**SF-3-5142**  
Ochsenbein  
Fig. 2

**SF-3-5143**  
Gardner  
Fig. 1

**SF-3-5144**  
Gardner  
Fig. 2

**SF-3-5145**  
Gardner  
Fig. 5

**SF-3-5146**  
Gardner  
Fig. 5R

**SF-3-5147**  
Gardner  
Fig. 6

**SF-3-5148**  
Wakefield  
Fig. 1W

**SF-3-5149**  
Wakefield  
Fig. 2W

**SF-3-5150**  
Buckley  
Fig. 3

## Bone Chisels and Gouges

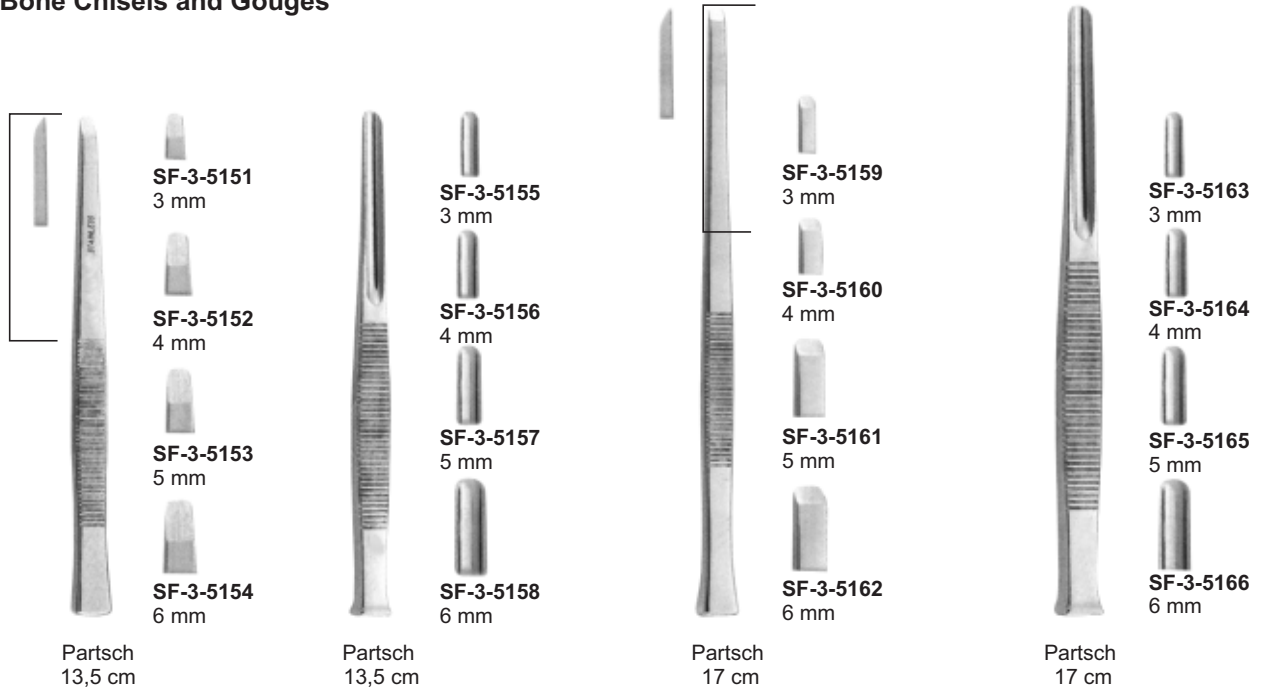

## Martelli chirurgici Mallet

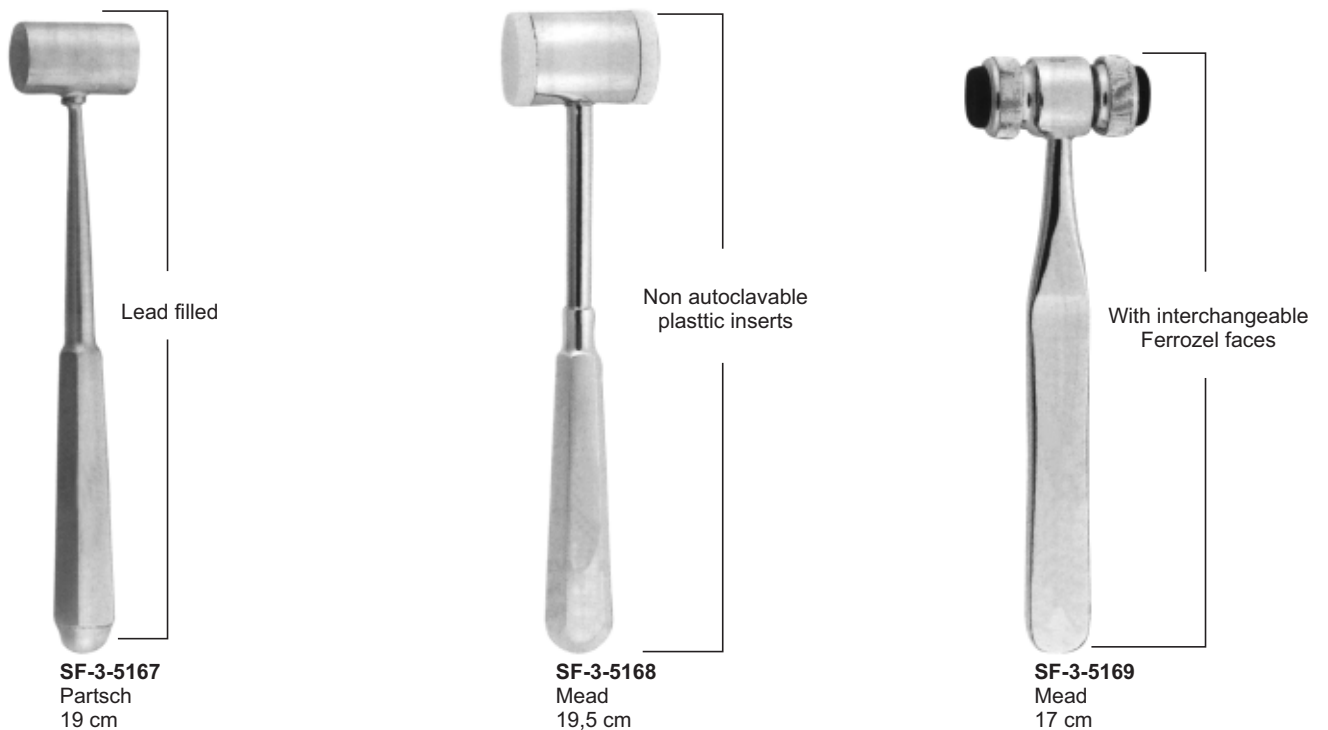



Surgiforce  
Instruments

Page  
68-74

▪ Currettes Scalers

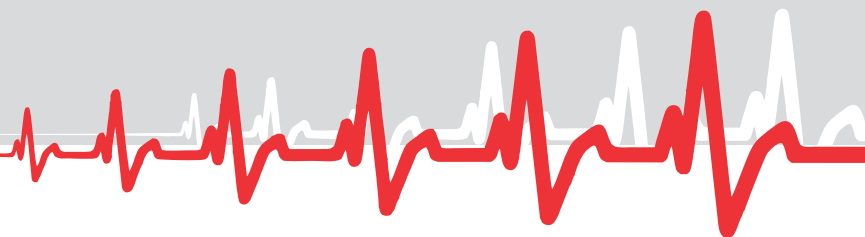

[www.surgiforce.com](http://www.surgiforce.com)

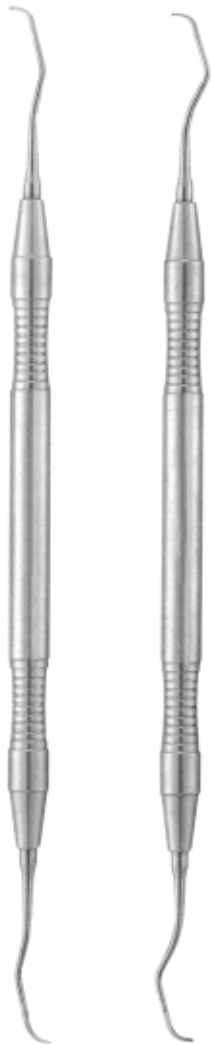
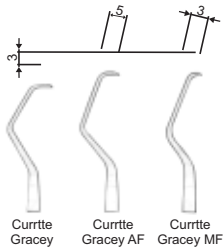

**SF-3-5170**  
Gracey  
Fig. 1/2



**SF-3-5171**  
Gracey  
Fig. 3/4



**SF-3-5172**  
Gracey  
Fig. 5/6



**SF-3-5173**  
Gracey  
Fig. 7/8



**SF-3-5174**  
Gracey  
Fig. 9/10



**SF-3-5175**  
Gracey  
Fig. 11/12



**SF-3-5176**  
Gracey  
Fig. 13/14



**SF-3-5177**  
Gracey  
Mesial Distal  
Fig. 11/14



**SF-3-5178**  
Gracey  
Mesial Distal  
Fig. 12/13

# Gracey Curettes AF Type

[www.surgiforce.com](http://www.surgiforce.com)

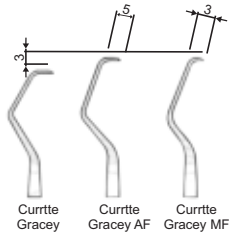

**SF-3-5179**  
Gracey  
AF/type  
Fig. 1/2



**SF-3-5180**  
Gracey  
AF/type  
Fig. 3/4



**SF-3-5181**  
Gracey  
AF/type  
Fig. 5/6



**SF-3-5182**  
Gracey  
AF/type  
Fig. 7/8



**SF-3-5183**  
Gracey  
AF/type  
Fig. 11/12



**SF-3-5184**  
Gracey  
AF/type  
Fig. 13/14



**SF-3-5185**  
Gracey  
AF/type  
Fig. 15/16



**SF-3-5186**  
Gracey  
AF/type



**SF-3-5187**  
Gracey  
AF/type  
Fig. 1/2



**SF-3-5188**  
Gracey  
AF/type  
Fig. 3/4



**SF-3-5189**  
Gracey  
AF/type  
Fig. 5/6



**SF-3-5190**  
Gracey  
AF/type  
Fig. 7/8



**SF-3-5191**  
Gracey  
AF/type  
Fig. 11/12



**SF-3-5192**  
Gracey  
AF/type  
Fig. 13/14



**SF-3-5193**  
Gracey  
AF/type  
Fig. 15/16



**SF-3-5194**  
Gracey  
MF/type  
Fig. 1/2



**SF-3-5195**  
Gracey  
MF/type  
Fig. 3/4



**SF-3-5196**  
Gracey  
MF/type  
Fig. 5/6



**SF-3-5197**  
Gracey  
MF/type  
Fig. 7/8



**SF-3-5198**  
Gracey  
MF/type  
Fig. 11/12



**SF-3-5199**  
Gracey  
MF/type  
Fig. 13/14



**SF-3-5200**  
Gracey  
MF/type  
Fig. 15/16

# Gracey Curettes AF Type

[www.surgiforce.com](http://www.surgiforce.com)

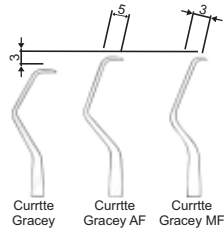

**SF-3-5201**  
Gracey  
MF/type  
Fig. 1/2



**SF-3-5202**  
Gracey  
MF/type  
Fig. 3/4



**SF-3-5203**  
Gracey  
MF/type  
Fig. 5/6



**SF-3-5204**  
Gracey  
MF/type  
Fig. 7/8



**SF-3-5205**  
Gracey  
MF/type  
Fig. 11/12



**SF-3-5206**  
Gracey  
MF/type  
Fig. 13/14



**SF-3-5207**  
Gracey  
MF/type  
Fig. 15/16



**SF-3-5208**  
Goldman - Fax  
Fig. 1



**SF-3-5209**  
Goldman - Fax  
Fig. 2



**SF-3-5210**  
Goldman - Fax  
Fig. 3



**SF-3-5211**  
Goldman - Fax  
Fig. 4



**SF-3-5212**  
Goldman - Fax  
Fig. 21

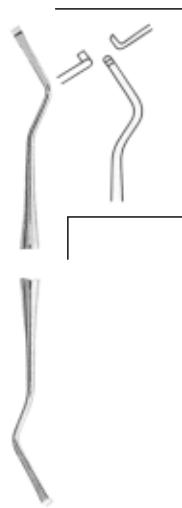

**SF-3-5213**  
Goldman - Fax  
Fig. 5



**SF-3-5214**  
Mc Call  
Fig. 13S/14S



**SF-3-5215**  
Younger-Good  
Fig. 7/8

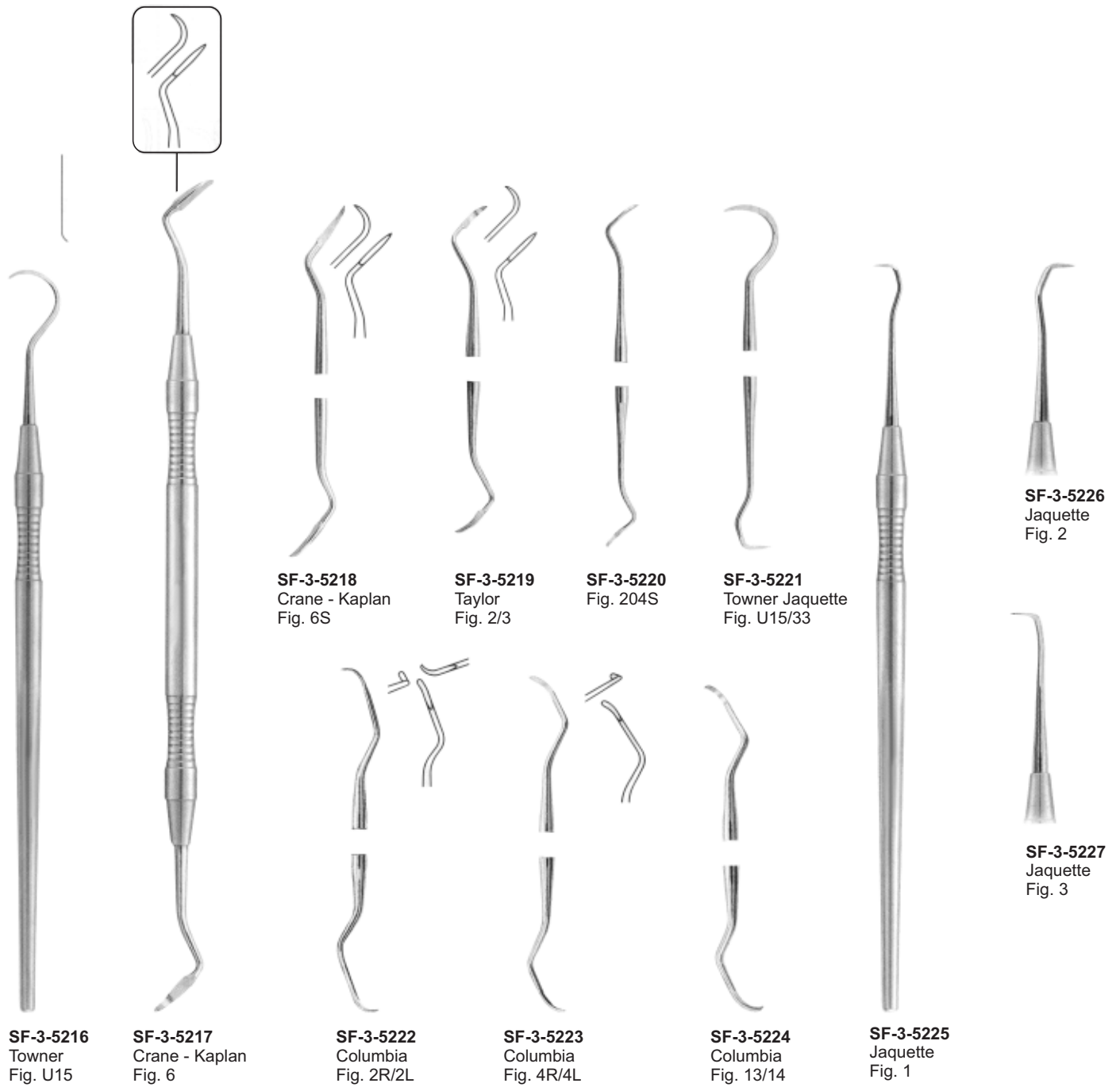



**SF-3-5228**  
Hemingway  
Fig. 1



**SF-3-5229**  
Hemingway  
Fig. 2



**SF-3-5230**  
Hemingway  
Fig. 3



**SF-3-5231**  
Lucas  
Fig. 85



**SF-3-5232**  
Lucas  
Fig. 86



**SF-3-5233**  
Lucas  
Fig. 87



Page  
75–77

- Modelling Instruments & Measuring Instruments

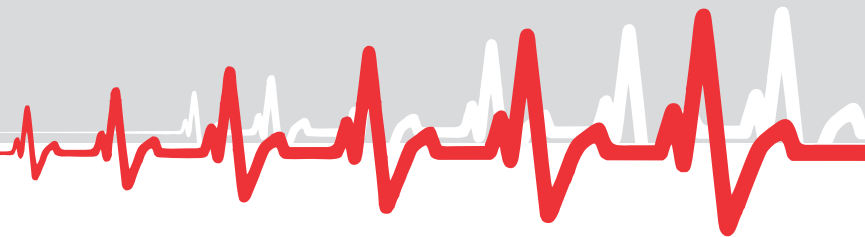

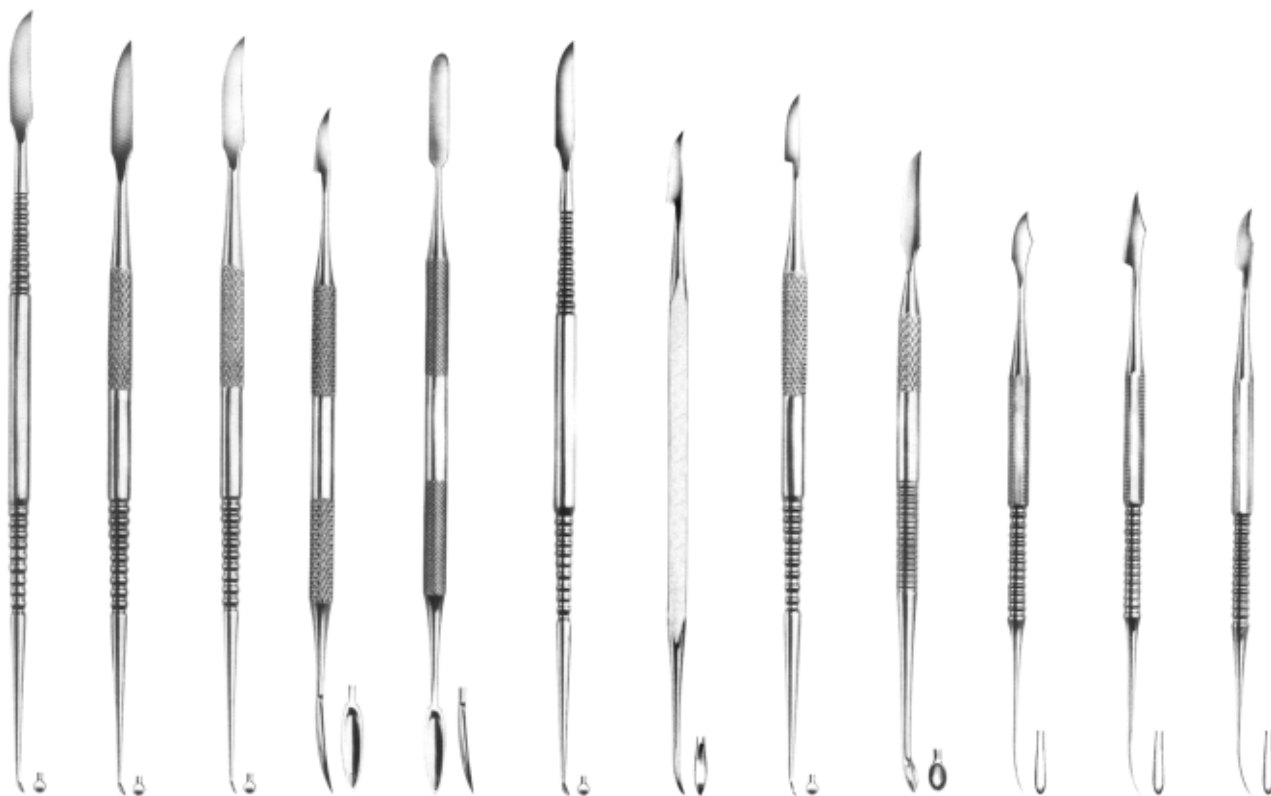

**SF-4-5101** Le Cron   
**SF-4-5102** Le Cron   
**SF-4-5103** Le Cron   
**SF-4-5104** MSY   
**SF-4-5105** MSY   
**SF-4-5106** Le Cron   
**SF-4-5107** Hylin   
**SF-4-5108** Hylin   
**SF-4-5109** Hylin   
**SF-4-5110** Zahle   
**SF-4-5111** Zahle   
**SF-4-5112** Zahle

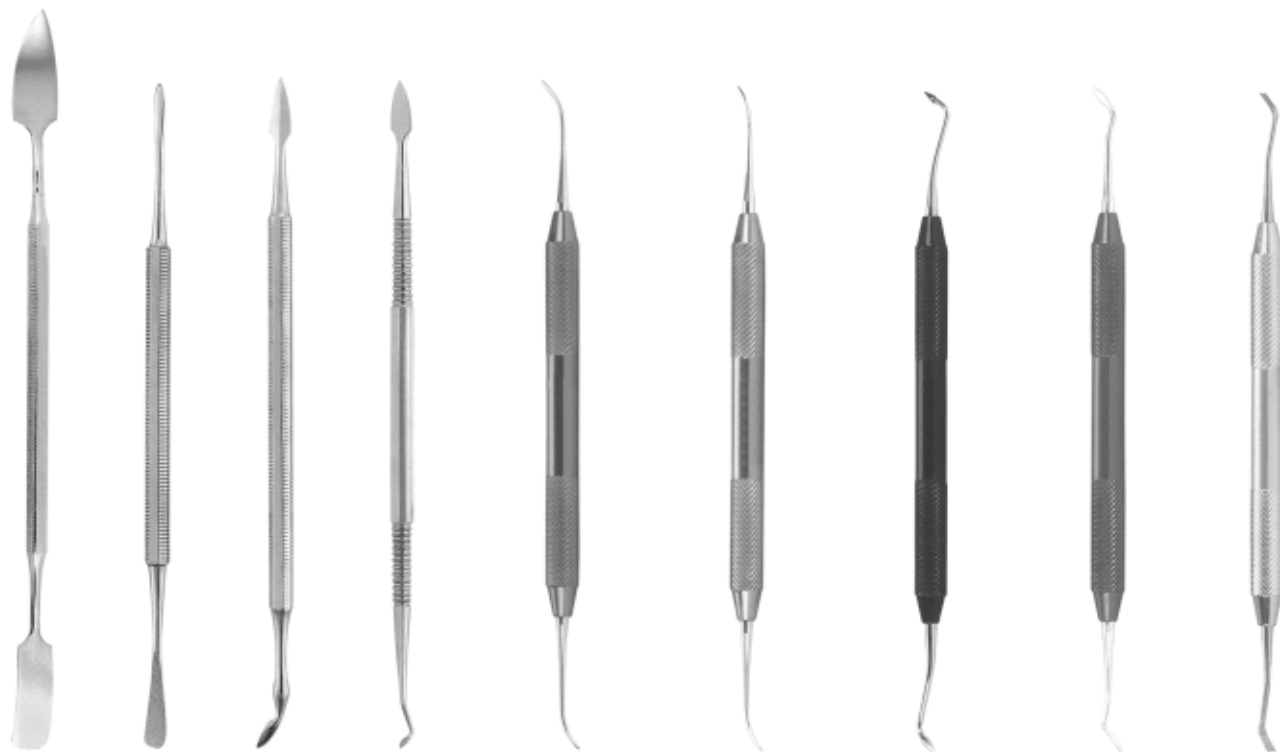

**SF-4-5113** Gritman   
**SF-4-5114** Beale   
**SF-4-5115** Roach   
**SF-4-5116** Vehe   
**SF-4-5117** P.K. Thomas Fig. 1   
**SF-4-5118** P.K. Thomas Fig. 2   
**SF-4-5119** P.K. Thomas Fig. 3   
**SF-4-5120** P.K. Thomas Fig. 4   
**SF-4-5121** P.K. Thomas Fig. 5



**SF-4-5122**  
Boley



**SF-4-5123**  
Zuricher  
130 mm



**SF-4-5124**  
Vernier  
12 cm



**SF-4-5125**  
Vernier

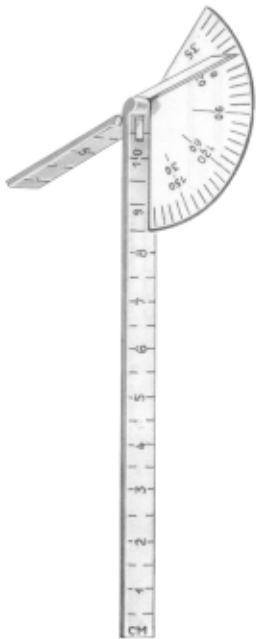

**SF-4-5126**  
Caroll



**SF-4-5127**  
Castroviejo's  
Scleral Marker



**SF-4-5128**  
Iwanson



**SF-4-5129**  
Albee



**SF-4-5130**  
18 cm  
7 1/8"



**SF-4-5131**  
18 cm  
7 1/8"



**SF-4-5132**  
17 cm  
6 3/4"  
Gritman

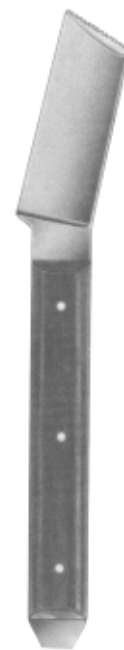

**SF-4-5133**  
17 cm  
6 3/4"  
Medicon



**SF-4-5134**  
22 cm  
8 3/4"



**SF-4-5135**  
Antkoviak



**SF-4-5136**  
Ermert



**SF-4-5137**  
Ermert

Page  
78–79

▪ Wax Knives/plaster

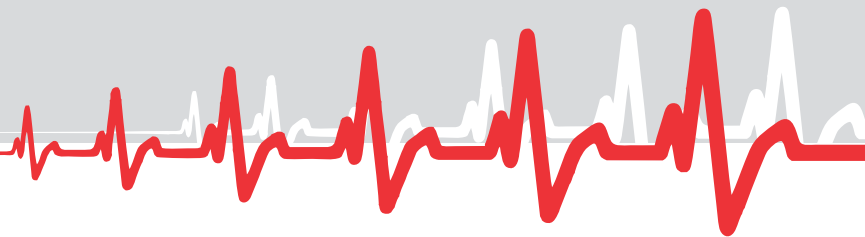



**SF-4-5138**  
Fahnenstock  
Fig. 1  
12,5cm



**SF-4-5139**  
Fahnenstock  
Fig. 2  
17cm



**SF-4-5140**  
Lessmann  
Fig. 1  
12,5cm



**SF-4-5141**  
Lessmann  
Fig. 2  
17cm



**SF-4-5142**  
Con scodellino  
Fig. 1  
12,5cm



**SF-4-5143**  
Con scodellino  
Fig. 2  
17cm



**SF-4-5144**  
Fig. 1  
17 cm



**SF-4-5145**  
Gritman  
Fig. 2  
17 cm



**SF-4-5146**  
Fig. 3  
16 cm



**SF-4-5147**  
Fig. 4  
16 cm

Page  
80–85

▪ Diagnostic, Explorer, Endodontic Instruments

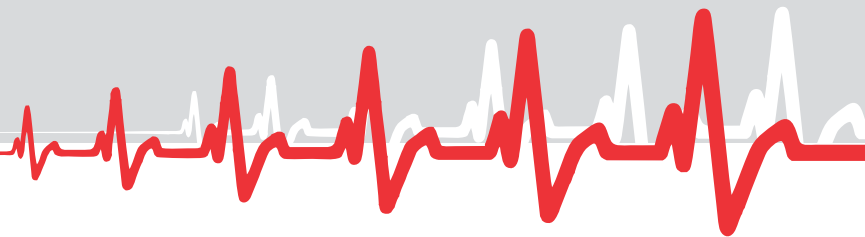



## Explorers



**SF-4-5148**  
Fig 23



**SF-4-5149**  
Fig 6



**SF-4-5150**  
Fig 8



**SF-4-5151**  
Fig 9



**SF-4-5152**  
Fig 17



**SF-4-5153**  
Fig 3  
Rein



**SF-4-5154**  
Fig 23/17



**SF-4-5155**  
Fig 17

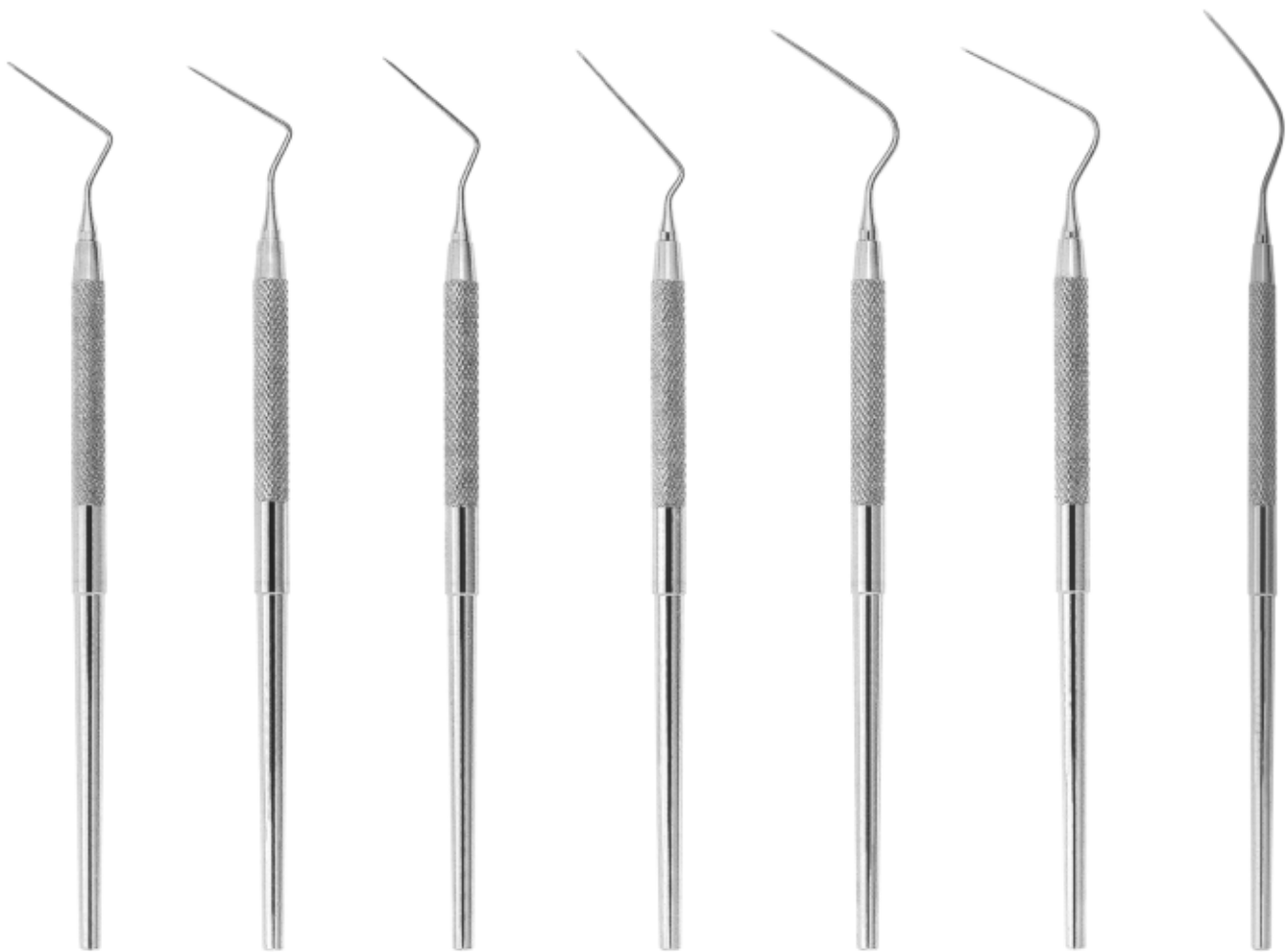

**SF-4-5156**  
Fig.1  
Spreader

**SF-4-5157**  
Fig.2  
Spreader

**SF-4-5158**  
Fig.3  
Spreader

**SF-4-5159**  
Fig.4  
Spreader

**SF-4-5110**  
Fig.5  
Spreader

**SF-4-5111**  
Fig.6  
Spreader

**SF-4-5112**  
Fig.7  
Spreader

## Double-Ended Root Canal Explorers Plugger/Spreaders

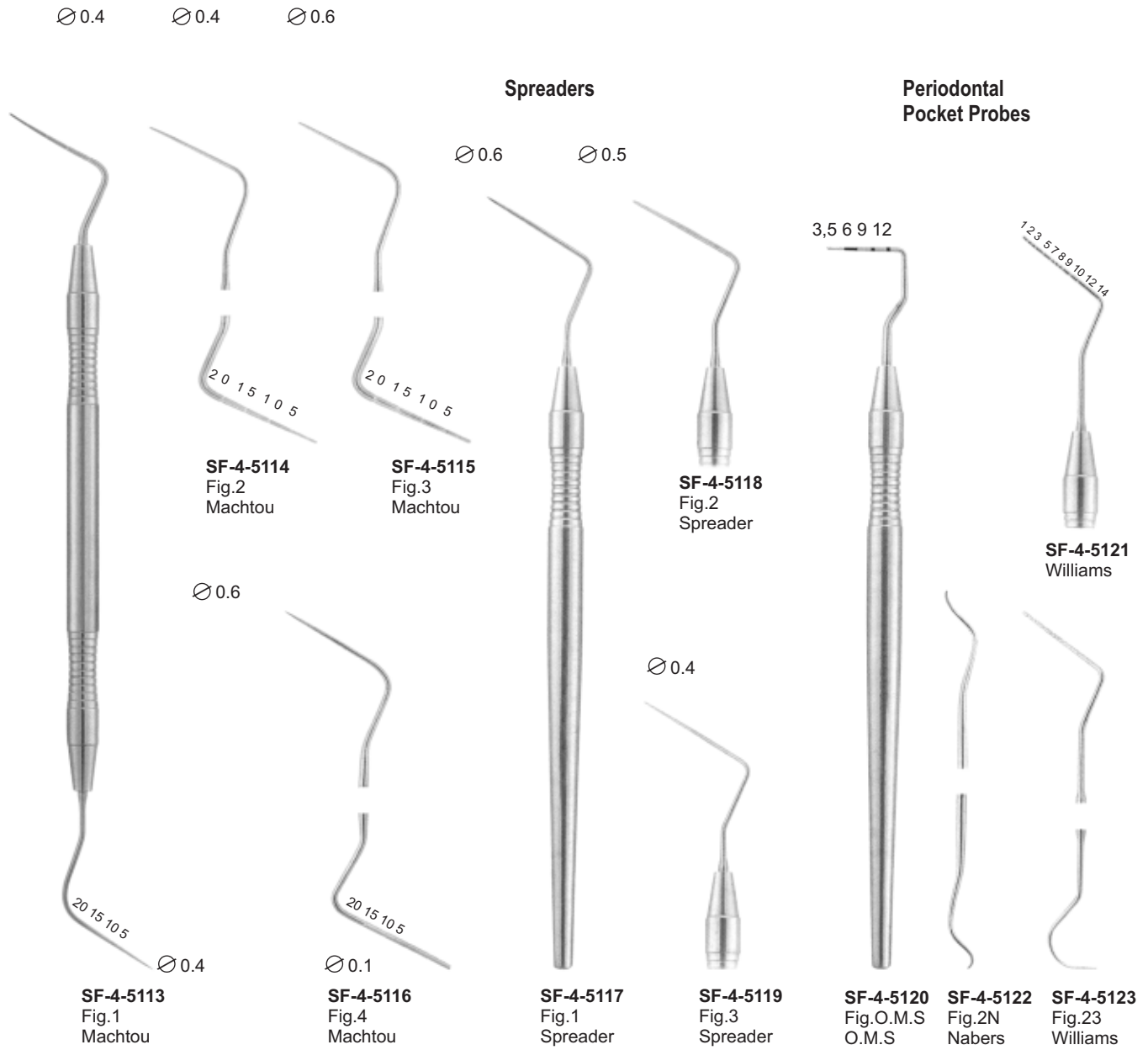



## Root-canal pluggers

Optimum Flexibility  
Very Fine Points

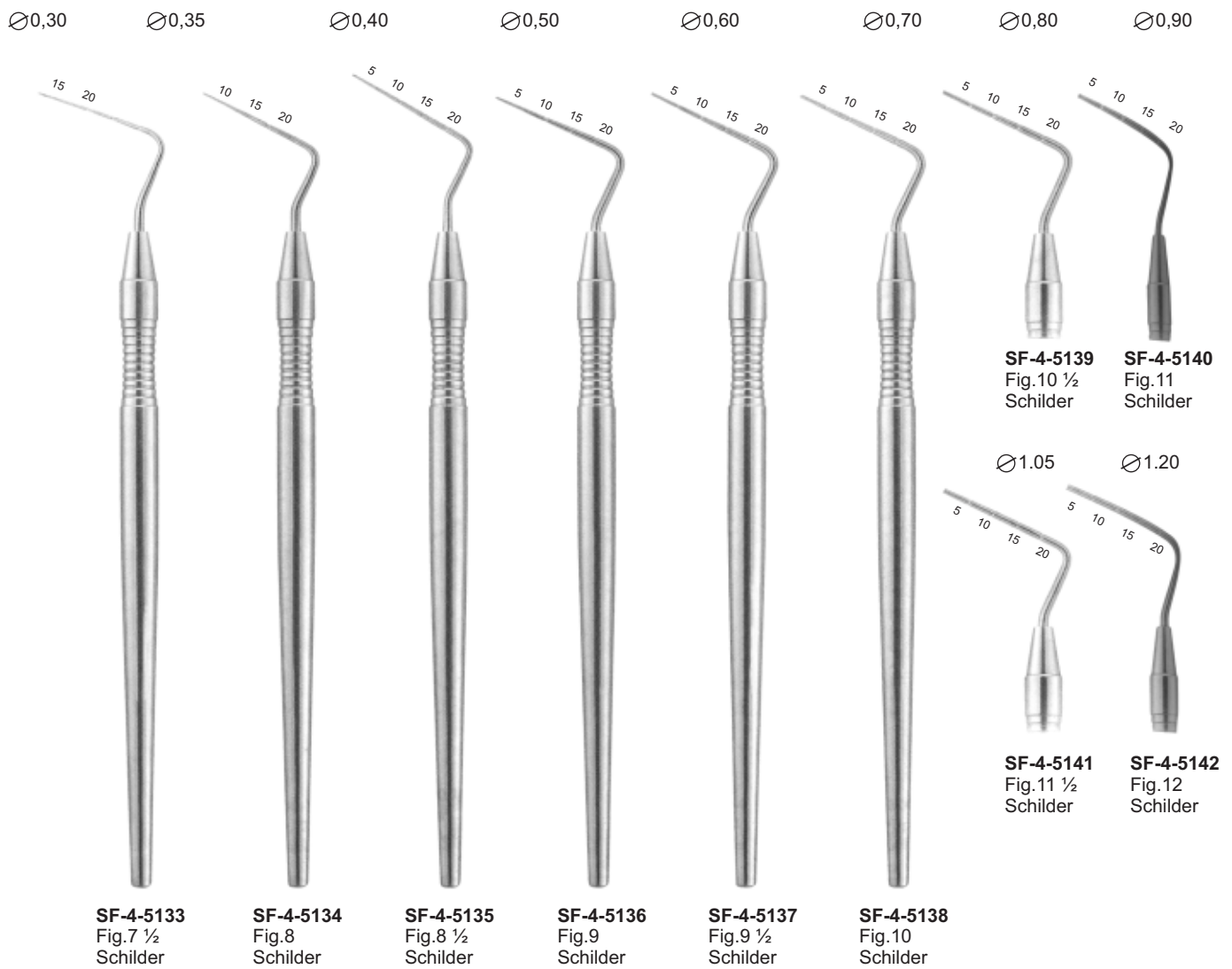

Root-canal explorers

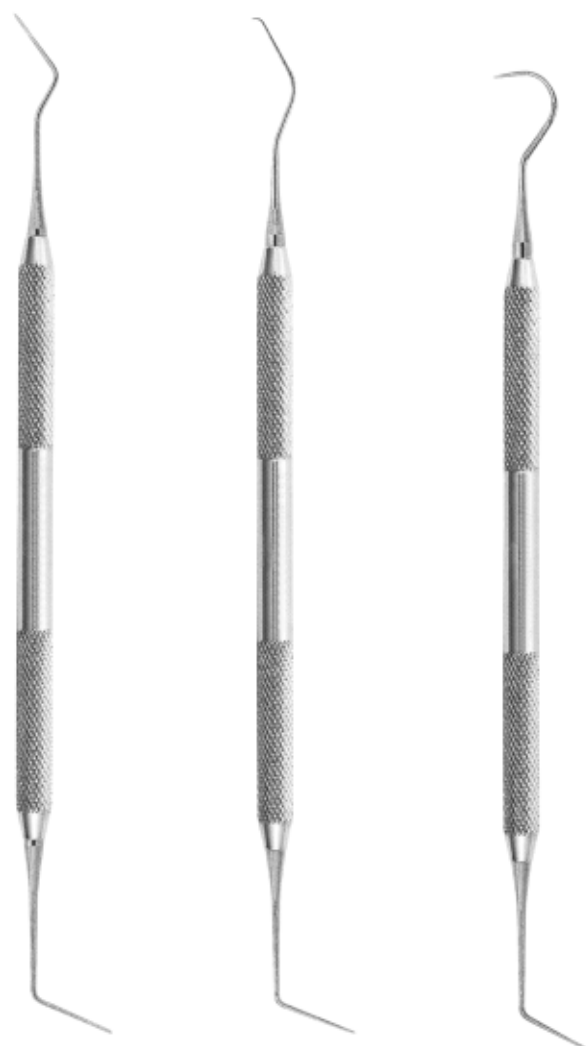

SF-4-5143  
Fig.6/1

SF-4-5144  
Fig.6/17

SF-4-5145  
Fig.6/23

Root-canal excavators



SF-4-5146  
Fig.31L

SF-4-5147  
Fig.32L

SF-4-5148  
Fig.33L

Page  
86-87

- Excavators

1 mm



**SF-4-5149**  
Fig 5

1.2 mm



**SF-4-5150**  
Fig 14

1 mm



**SF-4-5151**  
Fig 17

1.2 mm



**SF-4-5152**  
Fig 18

1.6 mm



**SF-4-5153**  
Fig 19

2 mm



**SF-4-5154**  
Fig 20



1 mm



**SF-4-5155**  
ASH  
Fig.243

1,4 mm



**SF-4-5156**  
ASH  
Fig.G2

0,8 mm



**SF-4-5157**  
Fig.1

0,8 mm



**SF-4-5158**  
Fig.2

1 mm



**SF-4-5159**  
Fig.11

1 mm



**SF-4-5160**  
Fig.12

1,2 mm



**SF-4-5161**  
Fig.21

1,2 mm



**SF-4-5162**  
Fig.22

1,6 mm



**SF-4-5163**  
Fig.31

1,6 mm



**SF-4-5164**  
Fig.32

2 mm



**SF-4-5165**  
Fig.41

2 mm



**SF-4-5166**  
Fig.42

Page  
88–89

- Handles For Mouth Mirrors

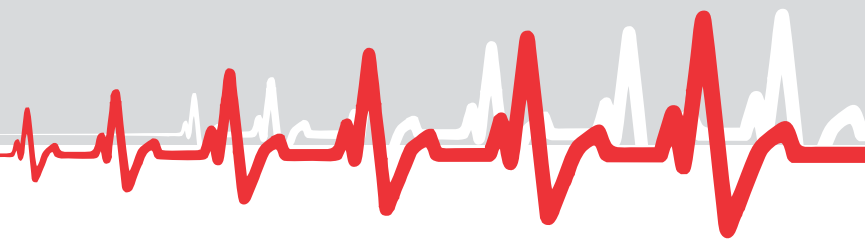

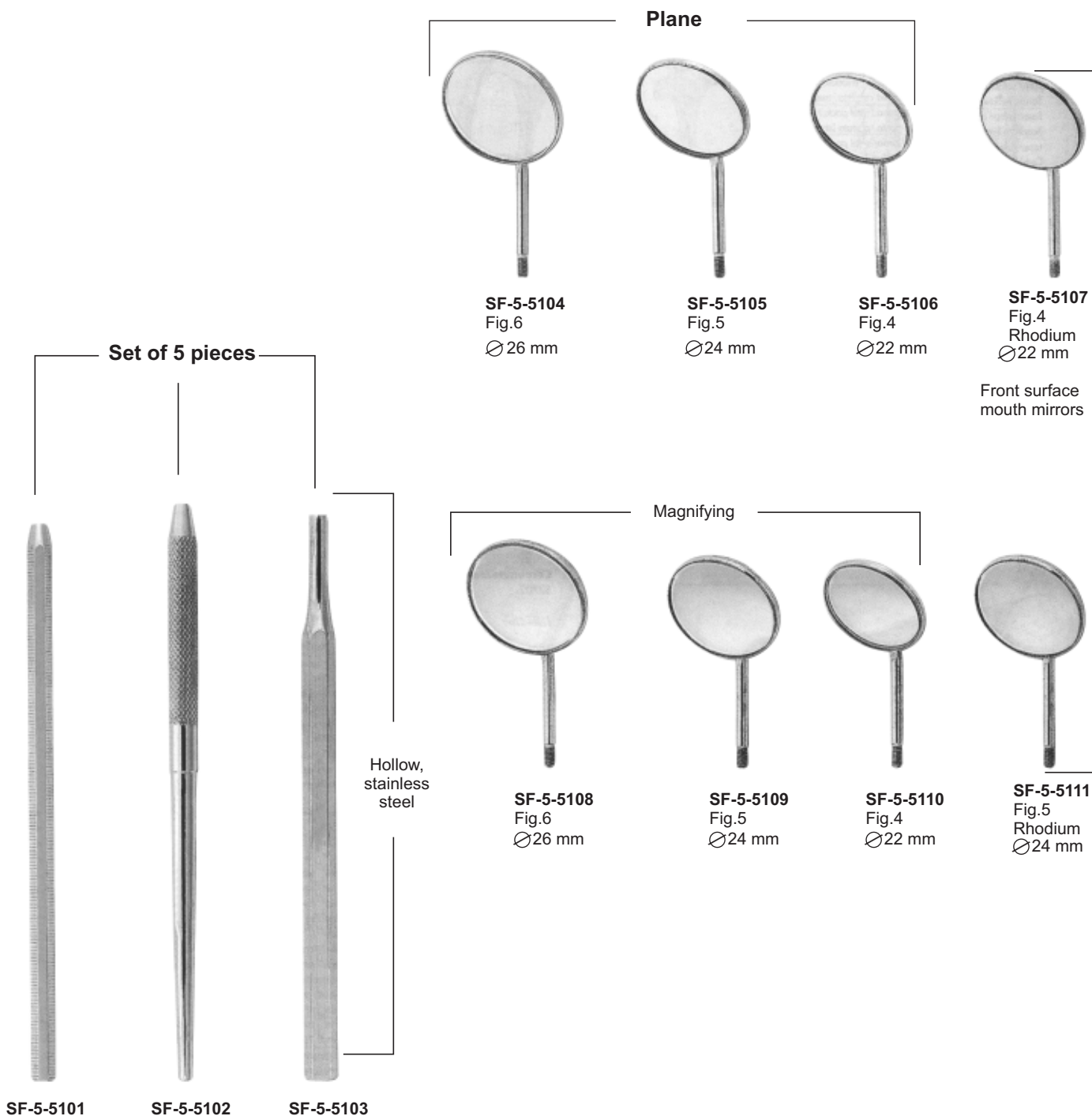

# Handles for Mouth Mirrors and Mouth Mirrors

[www.surgiforce.com](http://www.surgiforce.com)



**SF-5-5112**



**SF-5-5113**



**SF-5-5114**



**SF-5-5115**



**SF-5-5116**



**SF-5-5117**  
Parallelometer  
mouth mirror



**SF-5-5118**  
Parallelometer  
mouth mirror  
+ handle  
code 2101

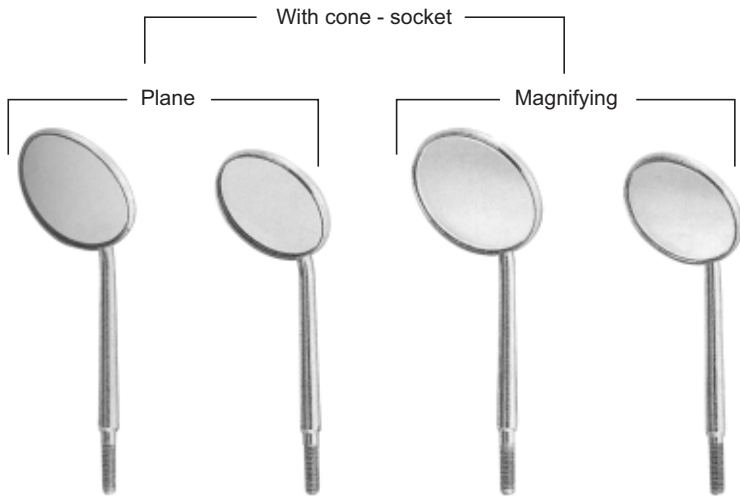

**SF-5-5119**  
Fig.5  
Ø24 mm

**SF-5-5120**  
Fig.4  
Ø22 mm

**SF-5-5121**  
Fig.5  
Ø 24 mm

**SF-5-5122**  
Fig.4  
Ø 22 mm



**SF-5-5123**  
Cone - socket



**SF-5-5124**  
Cone - socket



**SF-5-5125**  
Cone - socket

Page  
90–93

- Spatulas

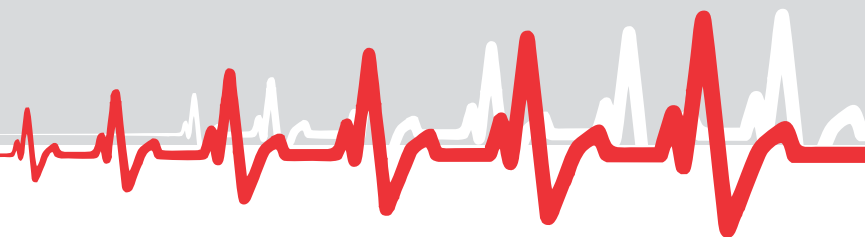

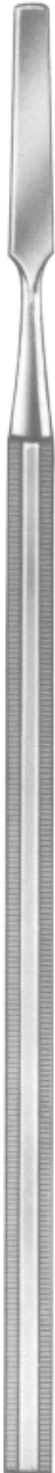

SF-5-5126



SF-5-5127



SF-5-5128



SF-5-5129

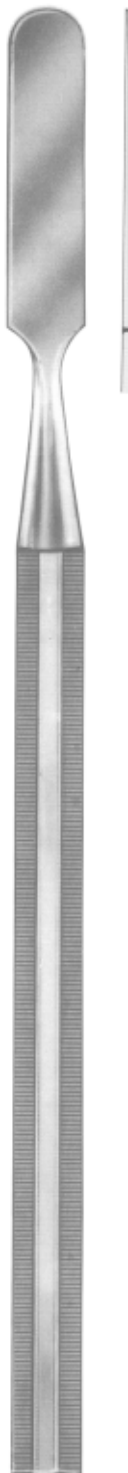

SF-5-5130



SF-5-5131



SF-5-5132



SF-5-5133

# Cement Spatulas

[www.surgiforce.com](http://www.surgiforce.com)

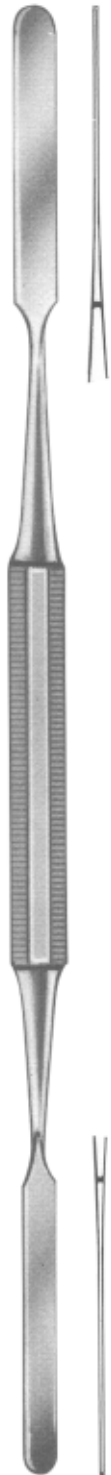

SF-5-5134



SF-5-5135



SF-5-5136

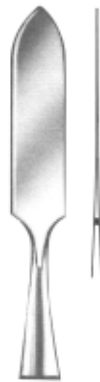

SF-5-5137



SF-5-5138



SF-5-5139



SF-5-5140



SF-5-5136



SF-5-5137



SF-5-5138



SF-5-5139



SF-5-5140





# Spatulas for Plaster and Alginate

[www.surgiforce.com](http://www.surgiforce.com)



Page  
94-100

- Needle Holders

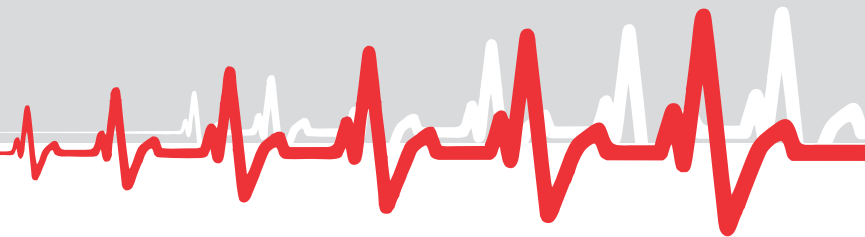



**SF-5-5150**  
Mayo-Hegar  
16 cm



**SF-5-5151**  
Mayo-Hegar TC  
16 cm



**SF-5-5152**  
Mayo-Hegar  
18 cm



**SF-5-5153**  
Mayo-Hegar TC  
18 cm



**SF-5-5154**  
Mini-Ryder  
18 cm



**SF-5-5155**  
Mini-Ryder  
15 cm



**SF-5-5156**  
Derf  
12 cm



**SF-5-5157**  
Hegar-Baumgarther  
14 cm

# Needle Holders

[www.surgiforce.com](http://www.surgiforce.com)



**SF-5-5158**  
Crile-Wood  
15 cm



**SF-5-5159**  
Crile-Wood TC  
15 cm



**SF-5-5160**  
Adson  
17.5 cm



**SF-5-5161**  
Olsen-Hegar  
14 cm



**SF-5-5162**  
Baumgarther  
14.5 cm



**SF-5-5163**  
Gillies  
16 cm



**SF-5-5164**  
Gillies  
16 cm



**SF-5-5165**  
Hegar-Baumgarther  
14 cm



**SF-5-5166**  
Toennis  
18 cm



**SF-5-5167**  
Toennis  
18 cm



**SF-5-5168**  
Lichtenberg  
17 cm



**SF-5-5169**  
Lichtenberg  
17 cm



**SF-5-5170**  
Eiselberg-Mathieu  
19.5 cm



**SF-5-5171**  
Boynton  
12 cm



**SF-5-5172**  
Arruga  
16 cm



**SF-5-5173**  
Boynton  
12 cm



**SF-5-5174**  
Arruga  
16 cm

# Needle Holders

[www.surgiforce.com](http://www.surgiforce.com)



**SF-5-5175**  
Castroviejo  
14 cm



**SF-5-5176**  
Castroviejo  
14 cm



**SF-5-5177**  
Castroviejo  
14/60 cm



**SF-5-5178**  
Castroviejo  
18 cm



**SF-5-5179**  
Castroviejo  
18 cm



**SF-5-5180**  
Castroviejo  
14 cm



**SF-5-5181**  
Castroviejo  
14 cm



**SF-5-5182**  
Castroviejo  
14/60 cm



**SF-5-5183**  
Castroviejo  
18 cm



**SF-5-5184**  
Castroviejo  
18 cm



**SF-5-5185**  
Mathieu  
14 cm



**SF-5-5186**  
Mathieu  
14 cm



**SF-5-5187**  
Mathieu  
14 cm



**SF-5-5188**  
Mathieu  
14 cm



**SF-5-5189**  
Mathieu  
17 cm



**SF-5-5190**  
Mathieu  
17 cm



**SF-5-5191**  
Mathieu  
14 cm



**SF-5-5192**  
Micro-Barraquer  
18 cm

# Needle Holders & Stainless Steel Saliva Ejectors

[www.surgiforce.com](http://www.surgiforce.com)



The tips have tungsten carbide inserts for better handling.



**SF-5-5193**  
Mathieu  
17 cm



**SF-5-5194**  
Mathieu  
17 cm



**SF-5-5195**  
Micro-Barraquer  
14 cm



**SF-5-5196**  
Castroviejo  
13 cm



**SF-5-5197**  
Castroviejo-Barraquer  
13 cm



**SF-5-5198**  
Castroviejo  
13 cm



**SF-5-5199**  
Castroviejo  
13 cm

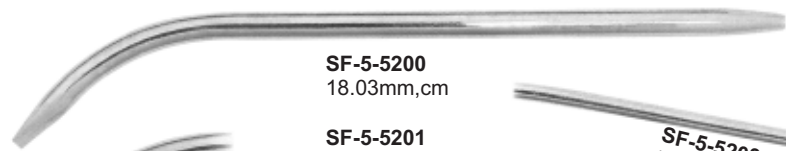

**SF-5-5200**  
18.03mm,cm



**SF-5-5201**  
18.04mm,cm



**SF-5-5202**  
18.05mm,cm



**SF-5-5203**  
Fig. 12FR  
Fraizer  
15.04mm,cm

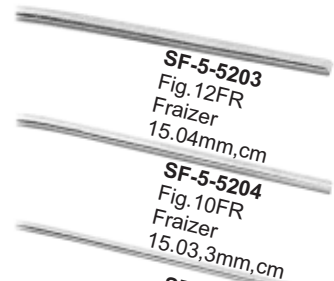

**SF-5-5204**  
Fig. 10FR  
Fraizer  
15.03, 3mm,cm

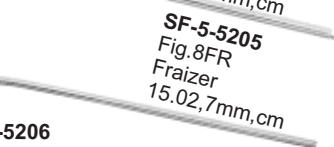

**SF-5-5205**  
Fig. 8FR  
Fraizer  
15.02, 7mm,cm



**SF-5-5206**  
Fig. 6FR  
Fraizer  
15.02mm,cm



0.4 **SF-5-5207**  
12.5 cm

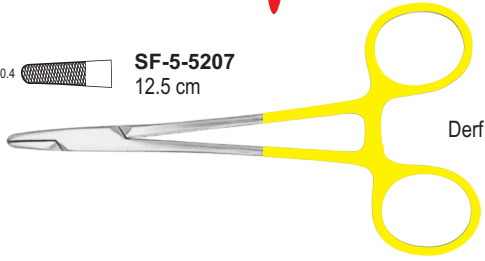

Derf

0.4 **SF-5-5214**  
14 cm

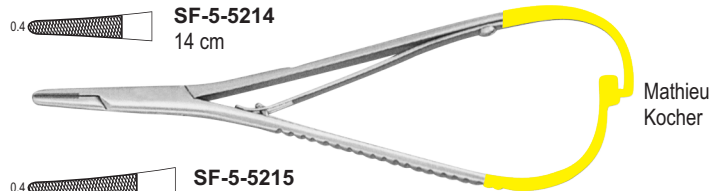

Mathieu  
Kocher

0.4 **SF-5-5208**  
13 cm

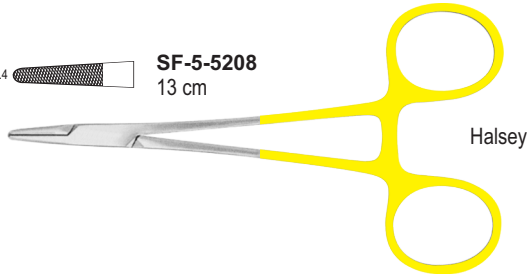

Halsey

0.4 **SF-5-5216**  
14 cm



Mathieu

0.5 **SF-5-5209**  
14.5 cm

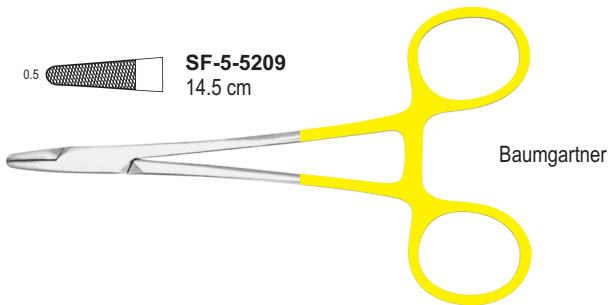

Baumgartner

0.4 **SF-5-5217**  
17 cm

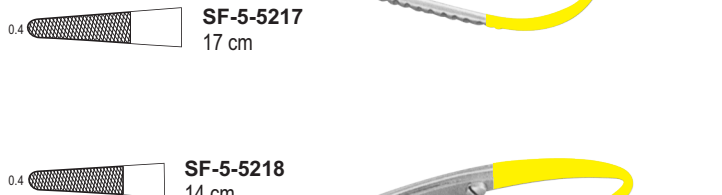

Mathieu

0.4 **SF-5-5210**  
15 cm

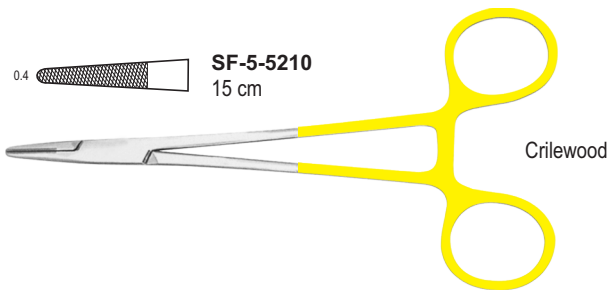

Crilewood

0.4 **SF-5-5218**  
14 cm



Mathieu

0.4 **SF-5-5219**  
17 cm



Mathieu

0.4 **SF-5-5211**  
15 cm

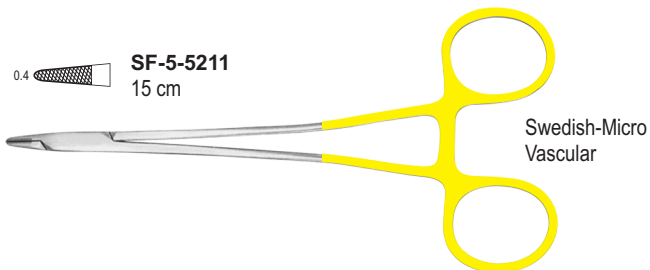

Swedish-Micro  
Vascular

0.4 **SF-5-5220**  
14 cm

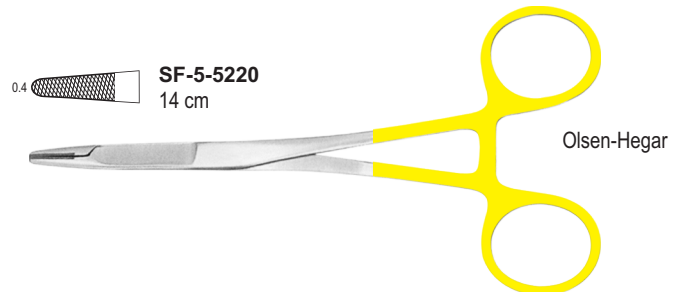

Olsen-Hegar

0.5 **SF-5-5212**  
16 cm

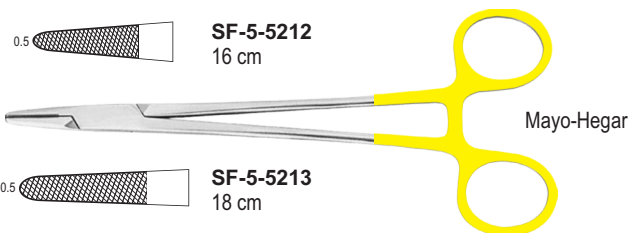

Mayo-Hegar

0.5 **SF-5-5221**  
18 cm



Toennis

0.5 **SF-5-5213**  
18 cm

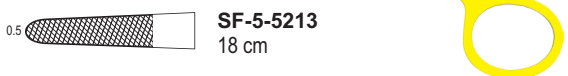

Mayo-Hegar

Surgiforce  
Instruments

Page  
101-109

- Syringes and Scissors

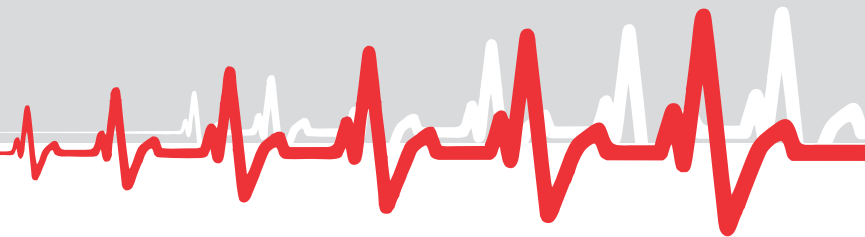



**SF-5-5222**

Water Syringe complete with 1 cannula (Lure-Lock)



**SF-5-5223**

Water Syringe complete with 1 cannula (Lure-Lock)



**SF-5-5224**

Metal water syringe, self-filling, with 1 cannula (Lure-Lock)



**SF-5-5225**

Sparrel Barrel with plunger suitable for syringes



**SF-5-5226**

Cannula, only, with Luer-Lock connector suitable for syringes



**SF-5-5227**  
Aspirating Syringe

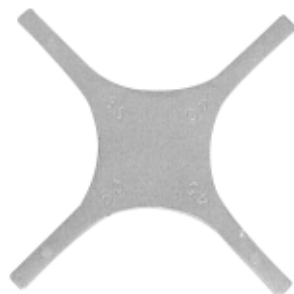

**SF-5-5228**  
Position Gauge

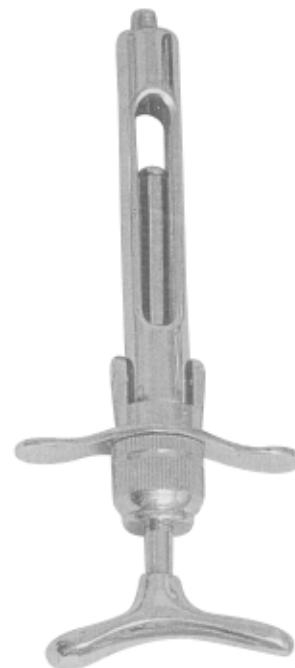

**SF-5-5229**  
Breech Loading Syringe



**SF-5-5230**  
Aspirating & Breech Syringe



**SF-5-5231**  
Band Adaptor



**SF-5-5232**  
Endo Finger Ruler  
With Adjustable Slide

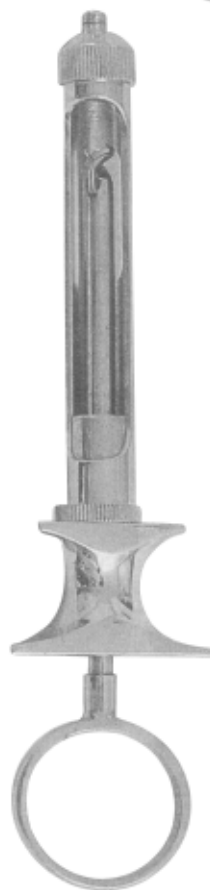

**SF-5-5233**  
Aspirating Syringe



SF-5-5234



SF-5-5235



SF-5-5236

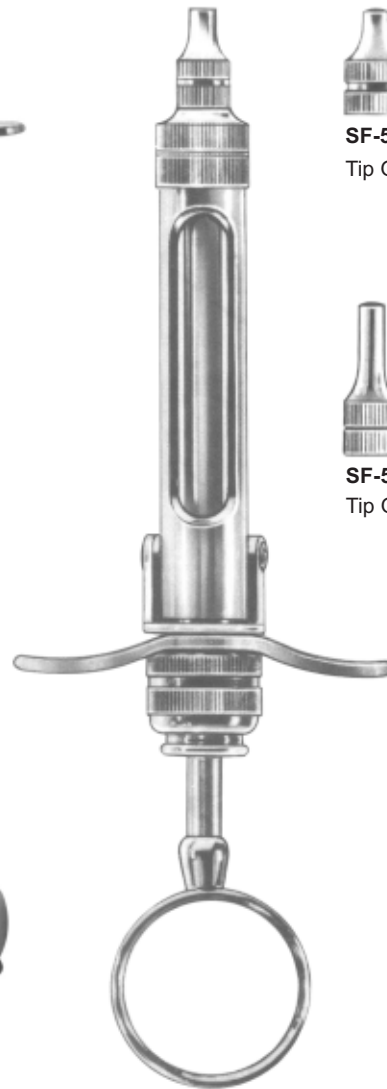

SF-5-5237 1,8 ml

SF-5-5238 2,2 ml

Cartridge Syringe complete  
With 2 tips and without needles



SF-5-5239

Tip Only, short



SF-5-5240

Tip Only, long



SF-5-5241



SF-5-5242



SF-5-5243



**SF-5-5244**  
Cork screw tip



**SF-5-5245**  
Cork screw tip



**SF-5-5246**  
Folding type, cork  
screw tip



**SF-5-5247**  
Folding type, cork  
screw tip



**SF-5-5248**



**SF-5-5249**  
Cork screw tip



**SF-5-5250**  
Spare cap with  
metric thread



**SF-5-5251**  
With Whitworth  
thread



**SF-5-5252**

Autoclavable Plastic Protection sleeve



**SF-5-5253**  
Brass syringe with stainless steel moving parts

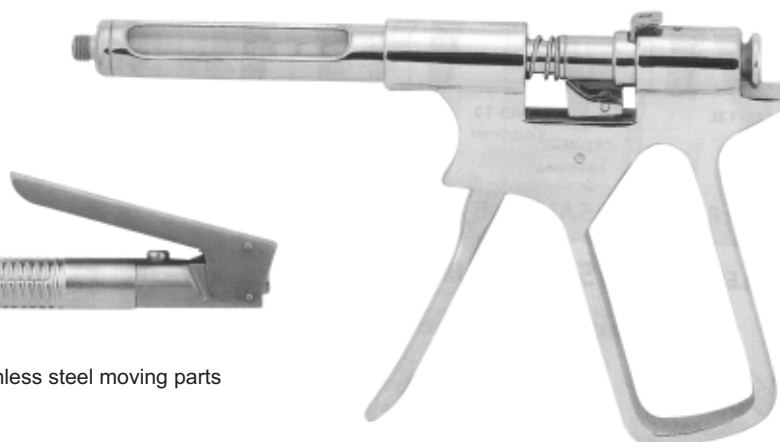

**SF-5-5254**  
Brass syringe with stainless  
steel moving parts

# Operating Scissors

[www.surgiforce.com](http://www.surgiforce.com)

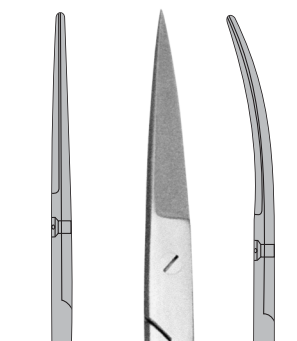

**SF-5-5255**  
11.5 cm  
**SF-5-5256**  
13 cm  
**SF-5-5257**  
14 cm



**SF-5-5258**  
11.5 cm  
**SF-5-5259**  
13 cm  
**SF-5-5260**  
14 cm

Standard  
Sharp / Sharp

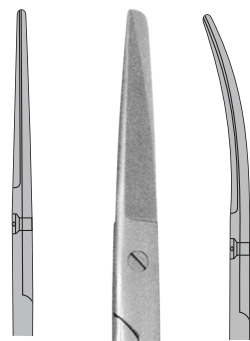

**SF-5-5261**  
11.5 cm  
**SF-5-5262**  
13 cm  
**SF-5-5263**  
14 cm



**SF-5-5264**  
11.5 cm  
**SF-5-5265**  
13 cm  
**SF-5-5266**  
14 cm

Standard  
Blunt / Sharp

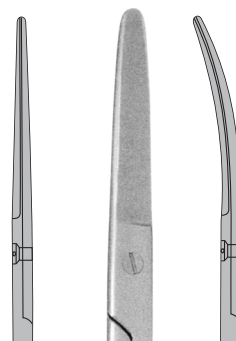

**SF-5-5267**  
11.5 cm  
**SF-5-5268**  
13 cm  
**SF-5-5269**  
14 cm



**SF-5-5270**  
11.5 cm  
**SF-5-5271**  
13 cm  
**SF-5-5272**  
14 cm

Standard  
Blunt / Blunt

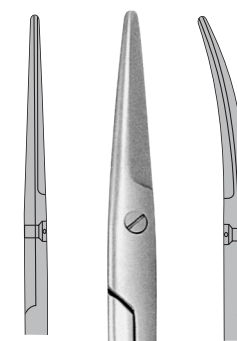

**SF-5-5273**

**SF-5-5274**



Mayo  
14.5 cm

## Suture Scissors | Tijeras para Hilos | Fadenscheren

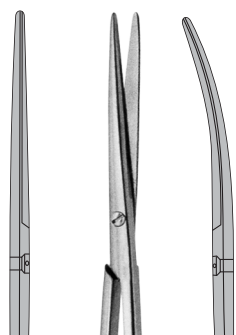

**SF-5-5275**



Metzenbaum-Delicate  
14.5 cm

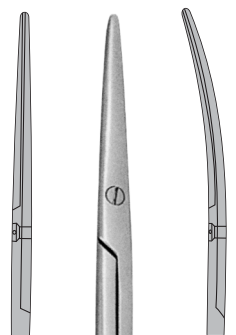

**SF-5-5278**



Metzenbaum  
14.5 cm

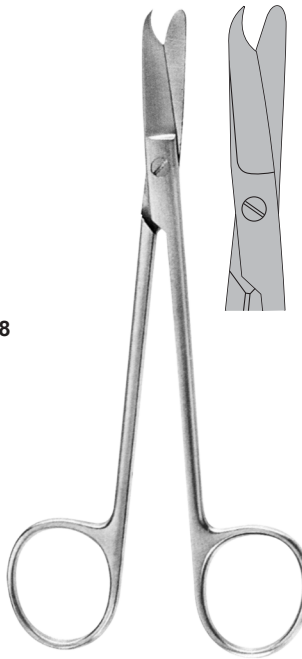

**SF-5-5279**  
Littauer  
14 cm

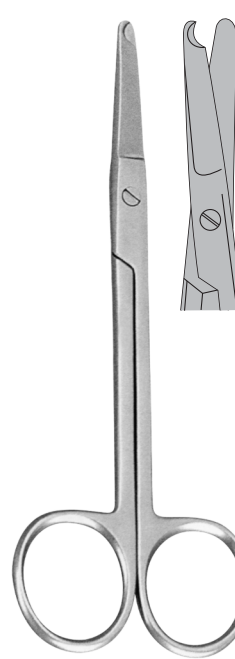

Spencer  
**SF-5-5280** 9 cm  
**SF-5-5281** 13 cm



Bandage Scissors Lister  
**SF-5-5282** 9 cm  
**SF-5-5283** 11 cm  
**SF-5-5284** 14 cm  
**SF-5-5285** 18 cm



Iris  
11.5 cm

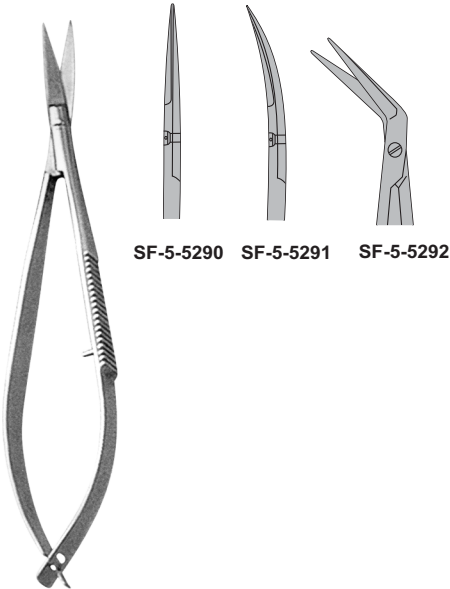

Noyes / Castroviejo  
12 cm

SF-5-52903  
La Grange  
11.5 cm



SF-5-5294  
Universal  
18 cm

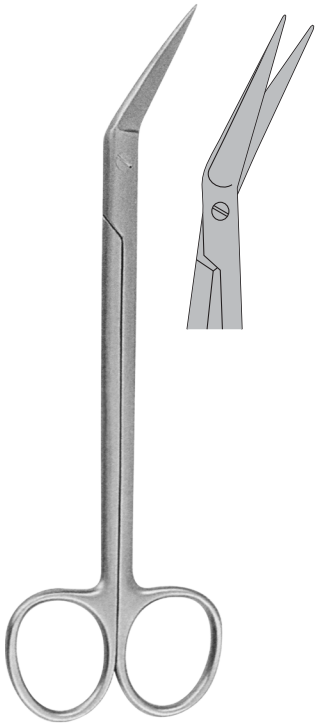

SF-5-5295  
Kelly  
16 cm

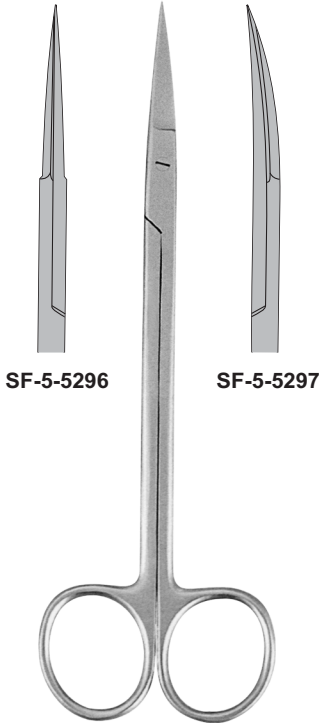

Kelly  
16 cm



SF-5-5298  
Goldman-Fox  
13 cm

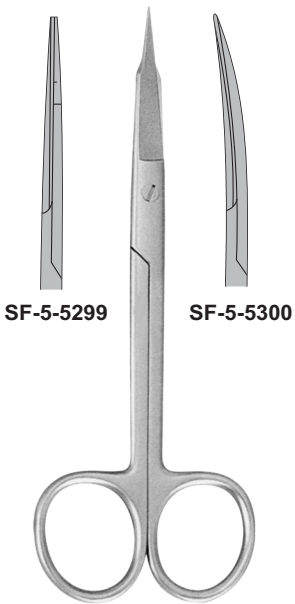

Goldman-Fox  
13 cm



# Scissors

[www.surgiforce.com](http://www.surgiforce.com)

## Scissors, One Blade Serrated

- One blade is with fine serrations to avoid tissue or ligature slippage.
- Manufactured from high quality stainless steel to provide longer-lasting cutting edge.
- Single black ring for easy identification.



Iris  
11.5 cm



Goldman-Fox  
13 cm

SF-5-5306  
Goldman-Fox  
13 cm

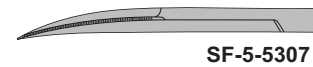

SF-5-5307

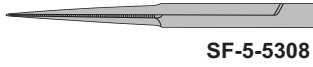

SF-5-5308

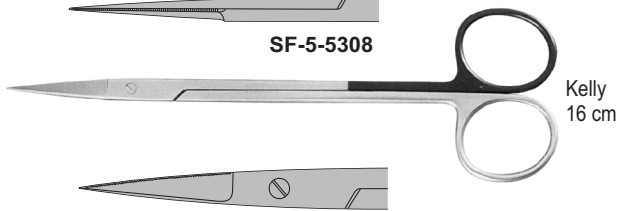

Kelly  
16 cm



SF-5-5309  
Locklin  
16 cm



SF-5-5310  
Locklin  
16 cm

## Super-Cut

- Cutting Blade horned to "razor" sharpness with opposing blade finished with fine serrations to avoid tissue slippage.
- Extremely smooth cutting with less trauma.
- Manufactured from high quality stainless steel to provide longer-lasting cutting edge.
- Single gold plated ring for easy identification.

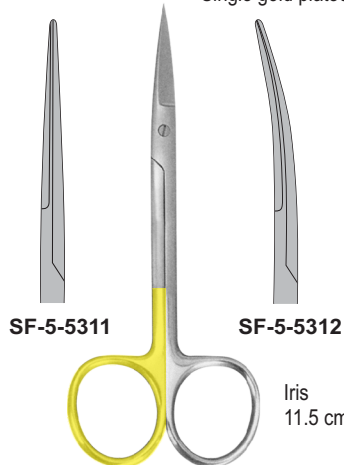

SF-5-5311

SF-5-5312

Iris  
11.5 cm



SF-5-5313  
La Grange  
11.5 cm

SF-5-5314

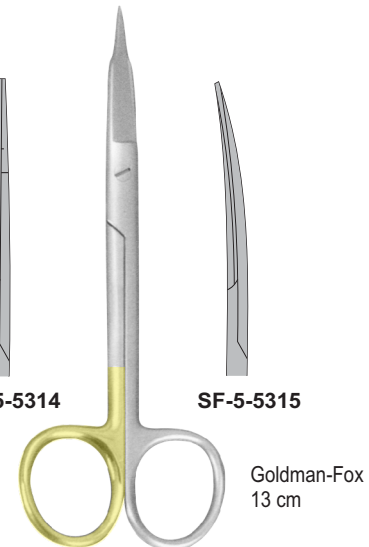

SF-5-5315

Goldman-Fox  
13 cm



Iris  
11.5 cm

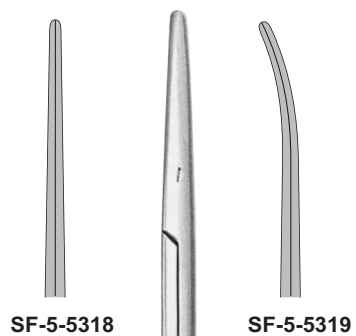

Metzenbaum  
14.5 cm

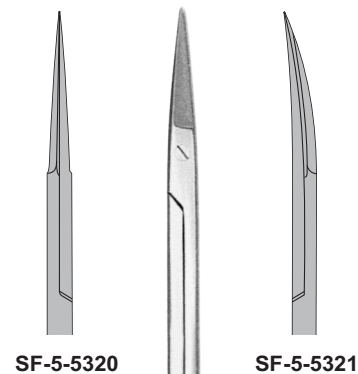

Kelly  
16 cm

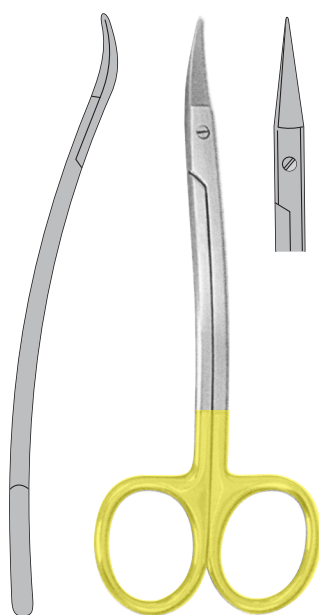

La Grange  
11.5 cm

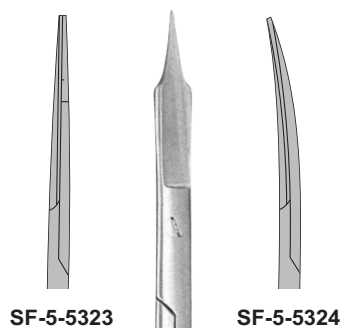

Goldman-Fox  
13 cm

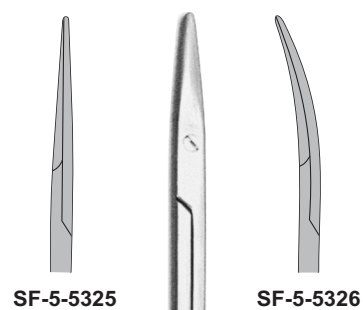

Strabismus  
11.5 cm

# Micro Scissors

[www.surgiforce.com](http://www.surgiforce.com)

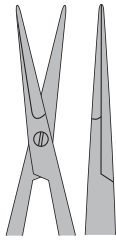
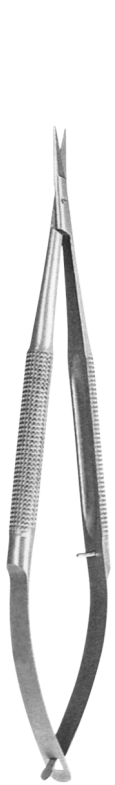

**SF-5-5327**  
15 cm

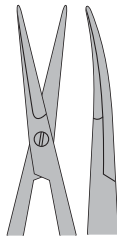

**SF-5-5328**  
15 cm

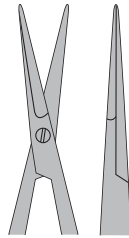
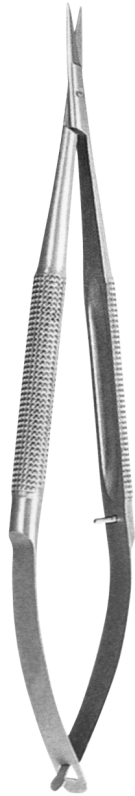

**SF-5-5329**  
18 cm

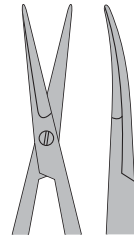

**SF-5-5330**  
18 cm

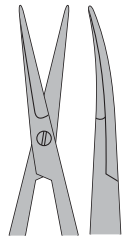

**SF-5-5331**  
18 cm

Micro Scissor  
Stainless Steel

Micro Scissor  
Stainless Steel

Micro Scissor  
Stainless Steel  
for ligature, one blade serrated

## Micro Scissors with Titanium Stainless Steel Tips

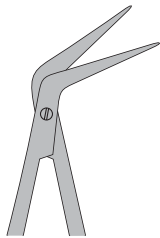
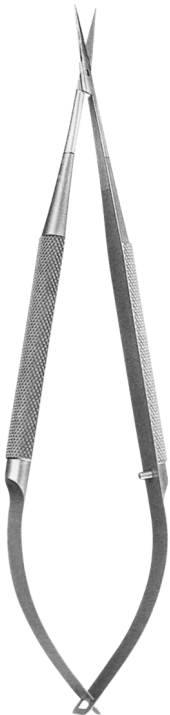

**SF-5-5332**  
18 cm

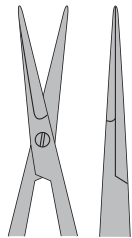

**SF-5-5333**  
18 cm

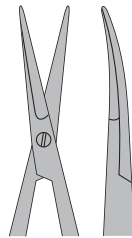

**SF-5-5334**  
18 cm

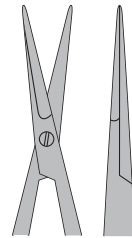

**SF-5-5335**  
15.5 cm

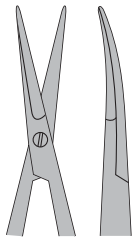

**SF-5-5336**  
15.5 cm

Page  
110-114

- Dental Tweezers

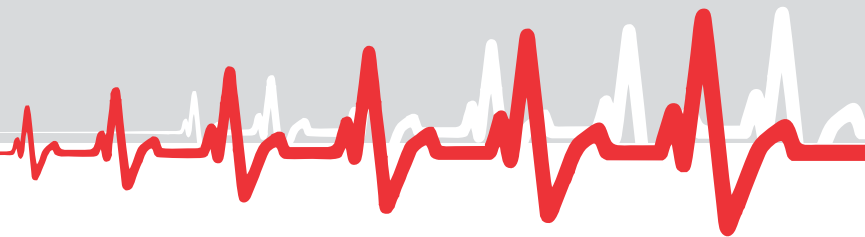



smooth

**SF-5-5337**  
College  
15 cm



serrated

**SF-5-5338**  
College  
15 cm



smooth

**SF-5-5339**  
College  
15 cm



serrated

**SF-5-5340**  
College  
15 cm



smooth

**SF-5-5341**  
College  
15 cm



serrated

**SF-5-5342**  
College  
15 cm



smooth

**SF-5-5343**  
College  
15 cm



serrated

**SF-5-5344**  
College  
15 cm

# Dental Tweezers

[www.surgiforce.com](http://www.surgiforce.com)

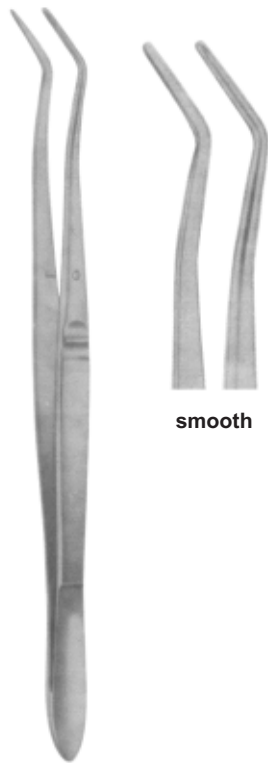

smooth

**SF-5-5345**  
Meriam  
16 cm

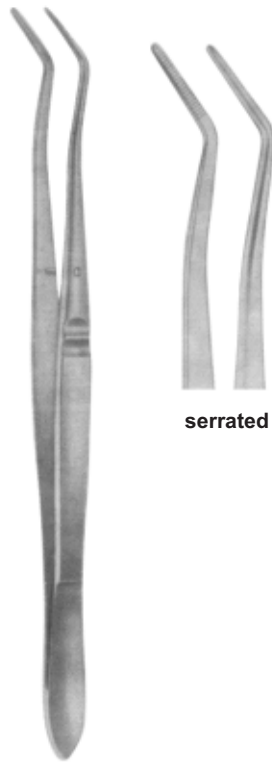

serrated

**SF-5-5346**  
Meriam  
16 cm

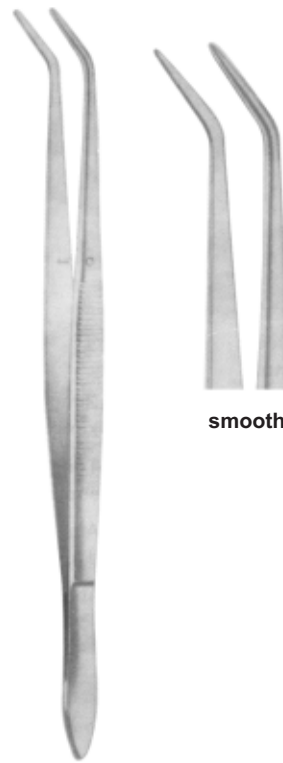

smooth

**SF-5-5347**  
Meriam  
16 cm

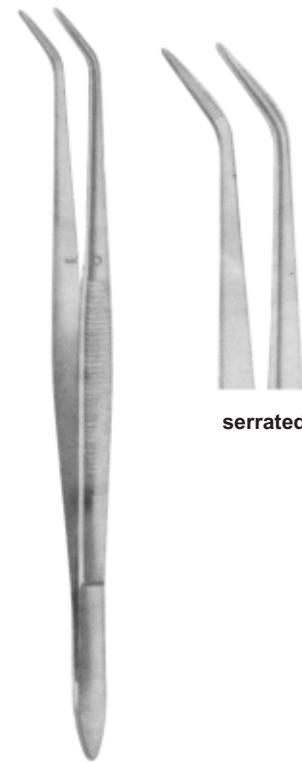

serrated

**SF-5-5348**  
Meriam  
16 cm

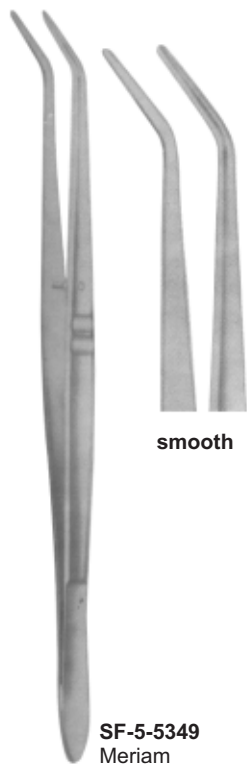

smooth

**SF-5-5349**  
Meriam  
16 cm

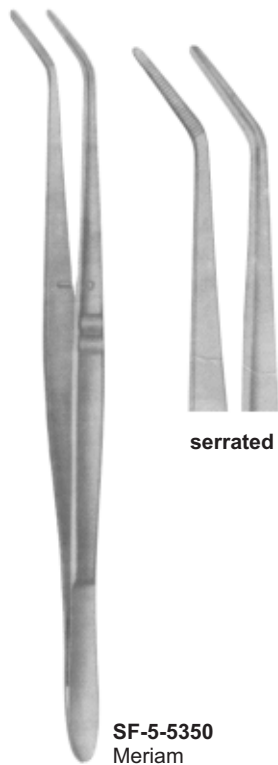

serrated

**SF-5-5350**  
Meriam  
16 cm

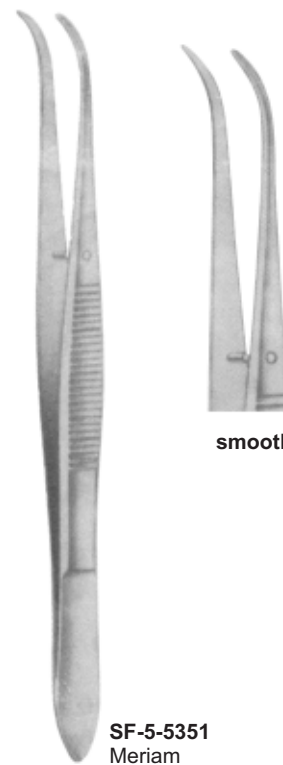

smooth

**SF-5-5351**  
Meriam  
16 cm

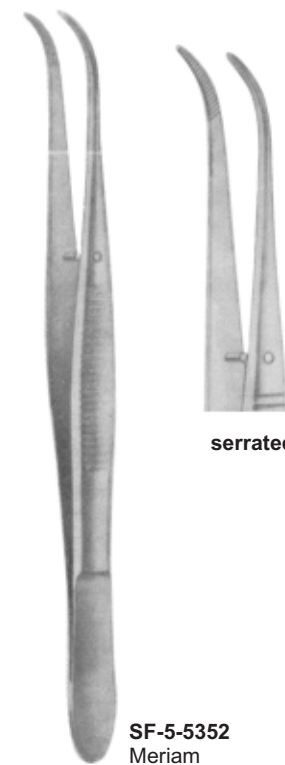

serrated

**SF-5-5352**  
Meriam  
16 cm

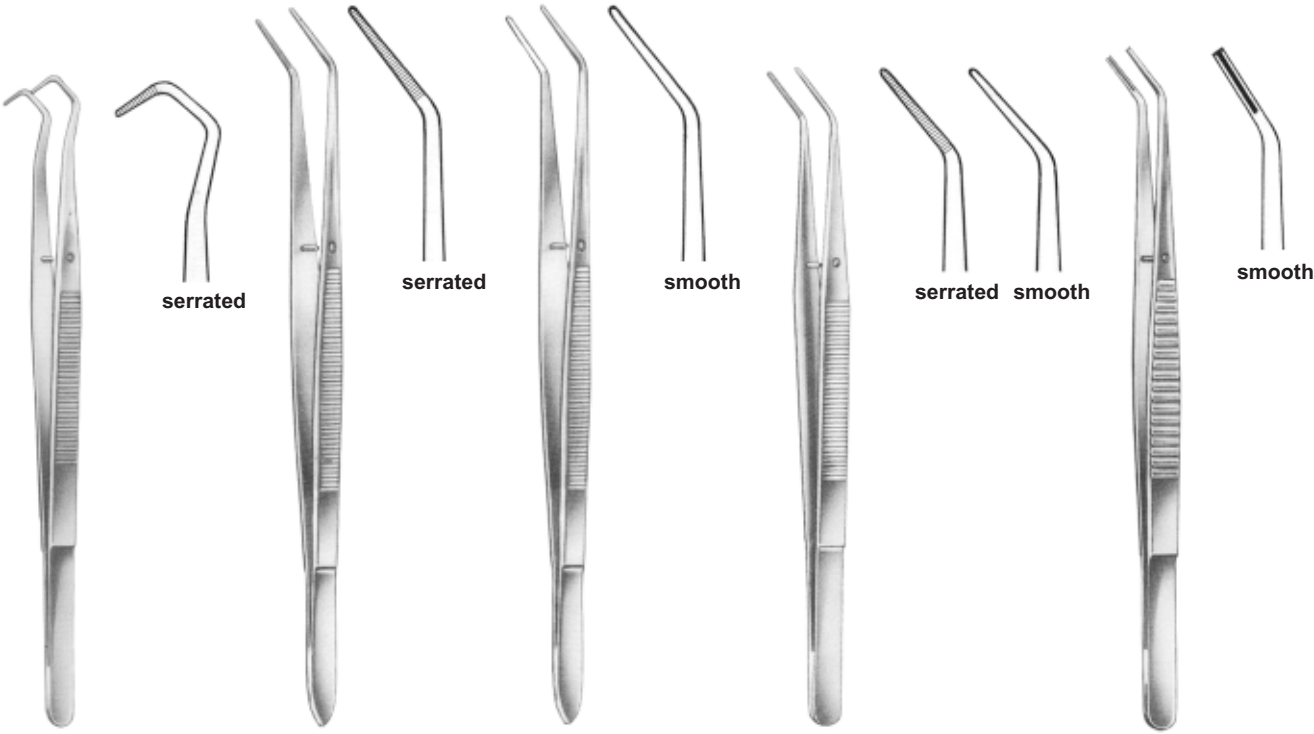

**SF-5-5353**  
College  
14.5 cm, 5<sup>3</sup>/<sub>4</sub>"

**SF-5-5354**  
Flagg  
16 cm, 6<sup>1</sup>/<sub>4</sub>"

**SF-5-5355**  
Flagg  
16 cm, 6<sup>1</sup>/<sub>4</sub>"

**SF-5-5356**  
Landgraf  
15 cm, 6"

**SF-5-5357**  
15,5 cm, 6<sup>1</sup>/<sub>8</sub>"

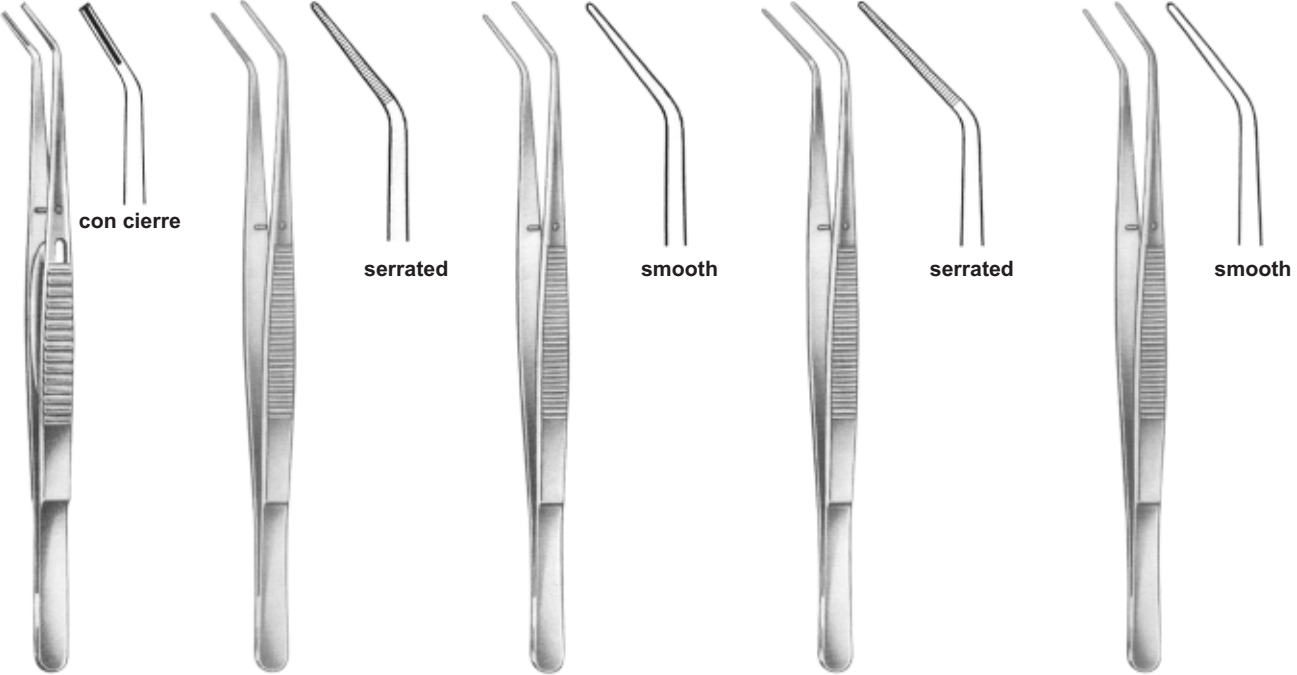

**SF-5-5358**  
15.5 cm, 6<sup>1</sup>/<sub>8</sub>"

**SF-5-5359**  
London-College  
15 cm, 6"

**SF-5-5360**  
London-College  
15 cm, 6"

**SF-5-5361**  
London-College  
15 cm, 6"

**SF-5-5362**  
London-College  
15 cm, 6"

# Dental Tweezers

[www.surgiforce.com](http://www.surgiforce.com)



**SF-5-5363**  
CK1  
15 cm, 6"

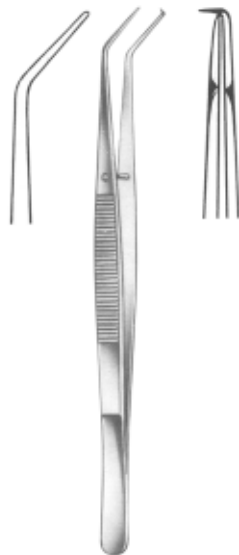

**SF-5-5364**  
CK2  
15 cm, 6"

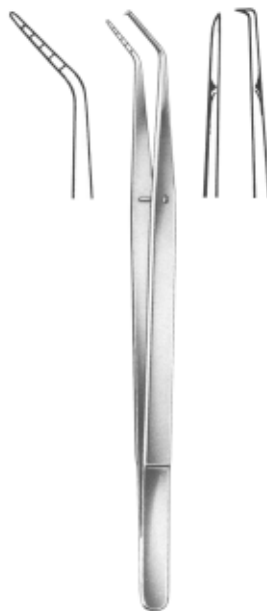

**SF-5-5365**  
GF2  
16 cm, 6 1/4"



**SF-5-5366**  
Gf1  
16 cm, 6 1/4"

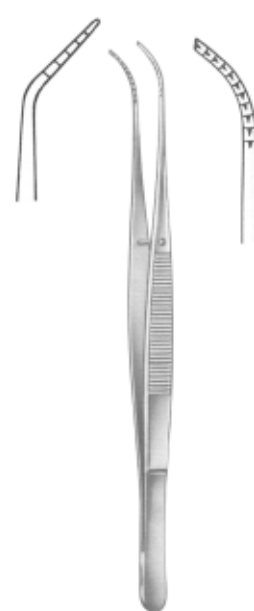

**SF-5-5367**  
Kopp  
15.5 cm, 6 1/8"



**SF-5-5368**  
Kopp  
15.5 cm, 6 1/8"



**SF-5-5369**  
15 cm, 6"



**SF-5-5370**  
16.5 cm, 6 1/2"



**SF-5-5371**  
15.5 cm, 6 1/8"



**SF-5-5372**  
15.5 cm, 6 1/8"



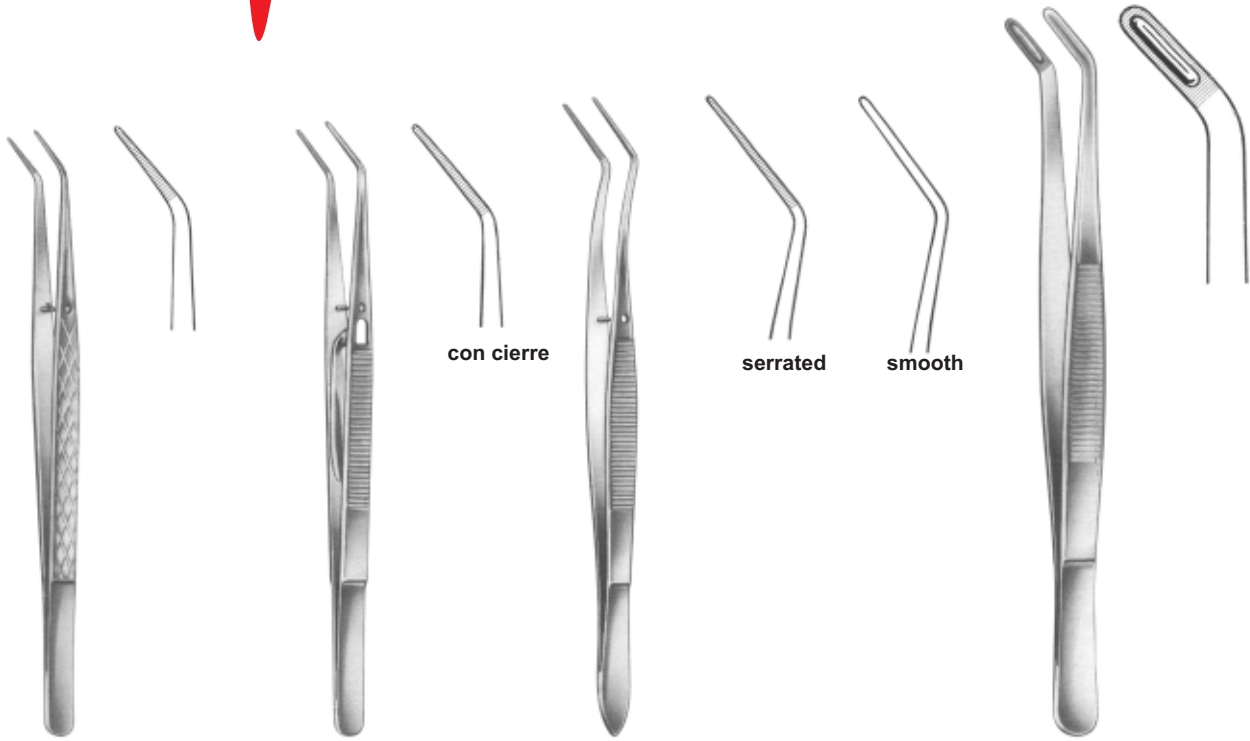

**SF-5-5373**  
London-College  
15 cm, 6"

**SF-5-5374**  
London-College  
15 cm, 6"

**SF-5-5375**  
Meriam  
16 cm, 6 1/4"

**SF-5-5376**  
Allen  
18 cm, 7 1/8"



**SF-5-5377**  
Albrecht  
16 cm, 6 1/4"

**SF-5-5378**  
Albrecht  
16 cm, 6 1/4"

**SF-5-5379**  
16 cm, 6 1/4"

**SF-5-5380**  
16 cm, 6 1/4"

**SF-5-5381**  
16 cm, 6 1/4"

Page  
115-117

- Rubber Dam Clamps

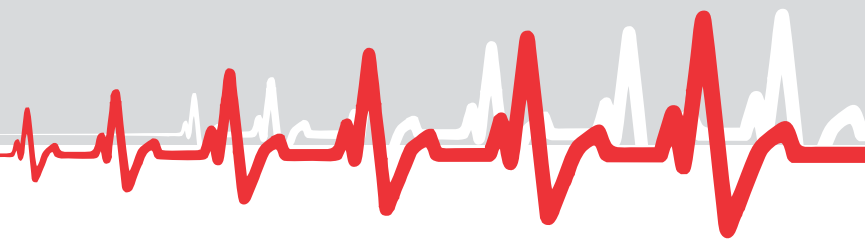

# Rubber Dam Clamp Forceps

[www.surgiforce.com](http://www.surgiforce.com)

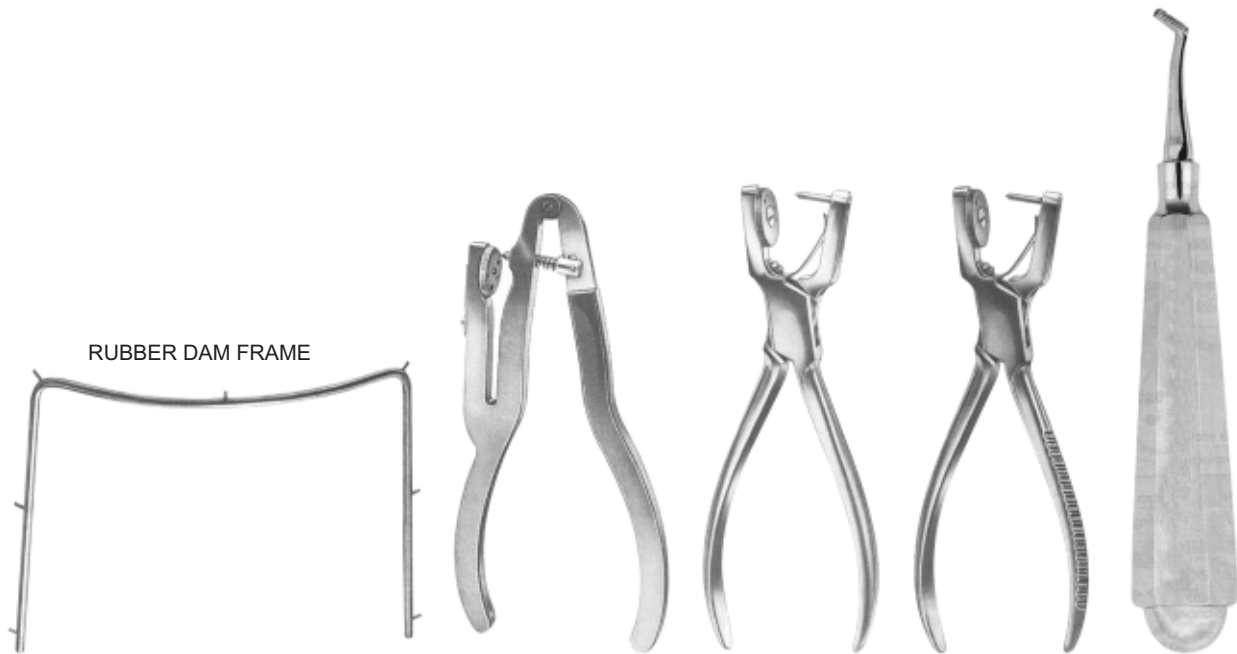

RUBBER DAM FRAME

**SF-5-5382**  
Young  
105x95 Inox

**SF-5-5383**  
Ivory  
160 mm

**SF-5-5384**  
Ainsworth  
170 mm

**SF-5-5385**  
Ainsworth  
170 mm

**SF-5-5386**  
Mershan  
140 mm

## CLAMPS ( PLIERS )

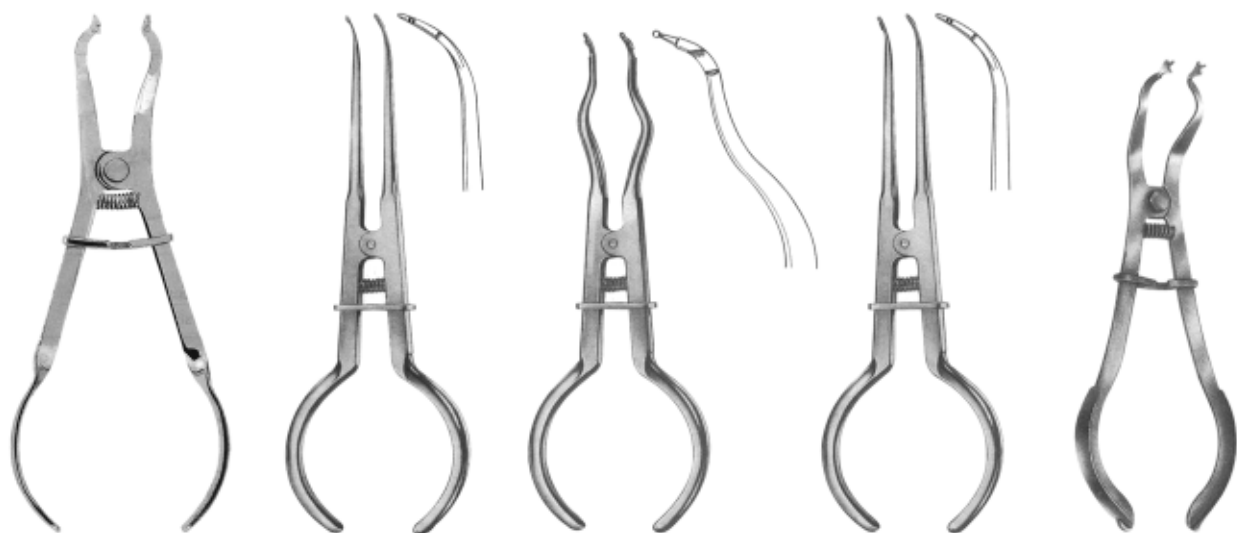

**SF-5-5387**  
Ivory light weight  
170 mm

**SF-5-5388**  
Brewer  
175 mm

**SF-5-5389**  
Brewer  
175 mm

**SF-5-5390**  
White  
175 mm

**SF-5-5391**  
Ivory  
170 mm



**SF-5-5392**  
Winged  
Labial Clamp



**SF-5-5393**  
Winged  
Edged Labial Clamp



**SF-5-5394**  
Winged  
Cervical Clamp



**SF-5-5395**  
Winged  
Labial Clamp



**SF-5-5396**  
Winged



**SF-5-5397**  
Winged



**SF-5-5398**  
Wingless

For Small Teeth, Elongated or With Narrow Collars



**SF-5-5399**  
Winged



**SF-5-5400**  
Winged



**SF-5-5401**  
Wingless

For General Use With Adjustable Jaws According  
To Gingival Line Shapes



**SF-5-5402**  
Winged



**SF-5-5403**  
Edged, Winged



**SF-5-5404**  
Wingless

For Premolars, With Elongated Collar



**SF-5-5405**  
Winged



**SF-5-5406**  
Edged, Winged



**SF-5-5407**  
Wingless

For Premolars, With Elongated Collar



**SF-5-5408**  
Wingless



**SF-5-5409**  
Wingless

# Rubber Dam Clamps

[www.surgiforce.com](http://www.surgiforce.com)



**SF-5-5410**  
Winged



**SF-5-5411**  
Wingless

**For Small Lower Molars**



**SF-5-5412**  
Winged



**SF-5-5413**  
Wingless

**For Small Lower Molars With Round clamps**



**SF-5-5414**  
Winged



**SF-5-5415**  
Wingless

**For Square Lower Molars**



**SF-5-5416**  
Winged



**SF-5-5417**  
Wingless

**For Round Upper Molars**



**SF-5-5418**  
Winged



**SF-5-5419**  
Wingless

**For Molar Roots**



**SF-5-5420**  
Winged



**SF-5-5421**  
Wingless

**For Partially Broken Molars**



**SF-5-5422**  
Winged



**SF-5-5423**  
Edged Winged



**SF-5-5424**  
Wingless



**SF-5-5425**  
Winged



**SF-5-5426**  
Wingless

**For Round Molars, Partially Broken, Undersized or Inclined**



**SF-5-5427**  
Wingless



**SF-5-5428**  
Wingless



**SF-5-5429**  
Winged



**SF-5-5430**  
Winged

Page  
118-122

- Matrix Retainer
- Matrix Bands

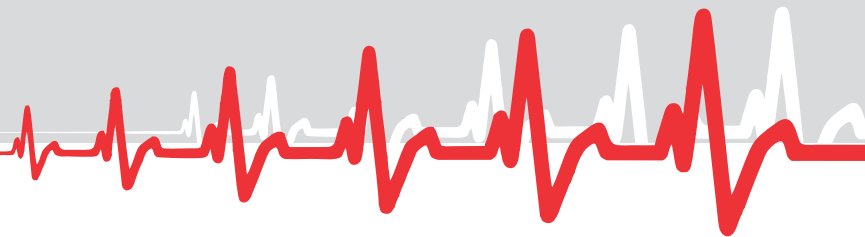



**SF-6-5101**  
Ivory  
63mm

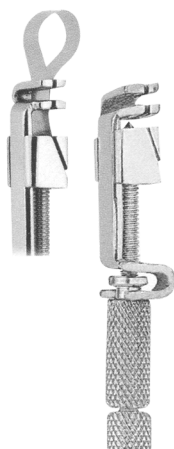

**SF-6-5102**  
Tofflemire-Universal



**SF-6-5103**  
Tofflemire-Junior



**SF-6-5104**  
Tofflemire-Senior



**SF-6-5105**  
Ivory 8  
5 mm



**SF-6-5106**  
Ivory 8  
6 mm



**SF-6-5107**  
Ivory 8  
7 mm



**SF-6-5108**  
Ivory 8 N



**SF-6-5109**  
Didner 8 P



**SF-6-5111**



**SF-6-5112**



**SF-6-5113**

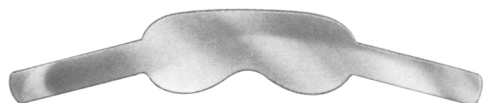

**SF-6-5114**

1750-5 mm x 100 cm  
1750-6 mm x 100 cm  
1750-7 mm x 100 cm



**SF-6-5110**

For Molars and Premolars



**SF-6-5115**



**SF-6-5116**



**SF-6-5117**

# Matrix Bands

[www.surgiforce.com](http://www.surgiforce.com)

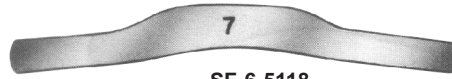

**7**  
SF-6-5118  
Molar  
Fig 7



**8**  
SF-6-5119  
Molar  
Fig 8

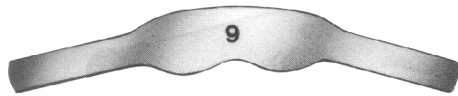

**9**  
SF-6-5120  
Molar  
Fig 9

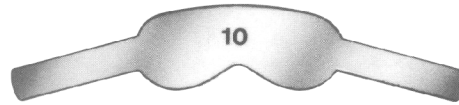

**10**  
SF-6-5121  
Molar  
Fig 10



**1**  
SF-6-5122  
Tofflemire



**2**  
SF-6-5123  
Tofflemire



**3**  
SF-6-5124  
Tofflemire



**11**  
SF-6-5125  
Bicuspid



**12**  
SF-6-5126  
Bicuspid



**13**  
SF-6-5127  
Bicuspid



**1**  
SF-6-5128  
Bicuspid



**2**  
SF-6-5129  
Bicuspid



**3**  
SF-6-5130  
Bicuspid



SF-6-5134



**1**  
SF-6-5131  
Molar



**2**  
SF-6-5132  
Molar



**3**  
SF-6-5133  
Molars



## Page 120–122

- Crown Removers
- Scissors
- Forceps
- Amalgum Guns
- Carries

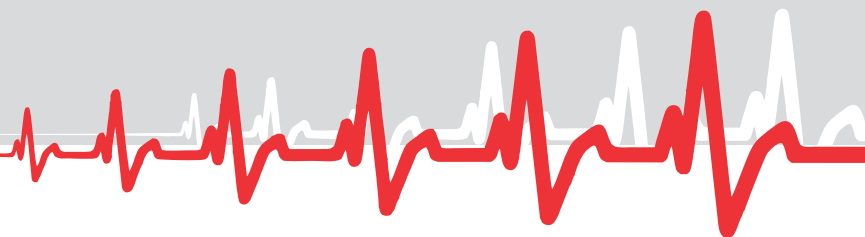

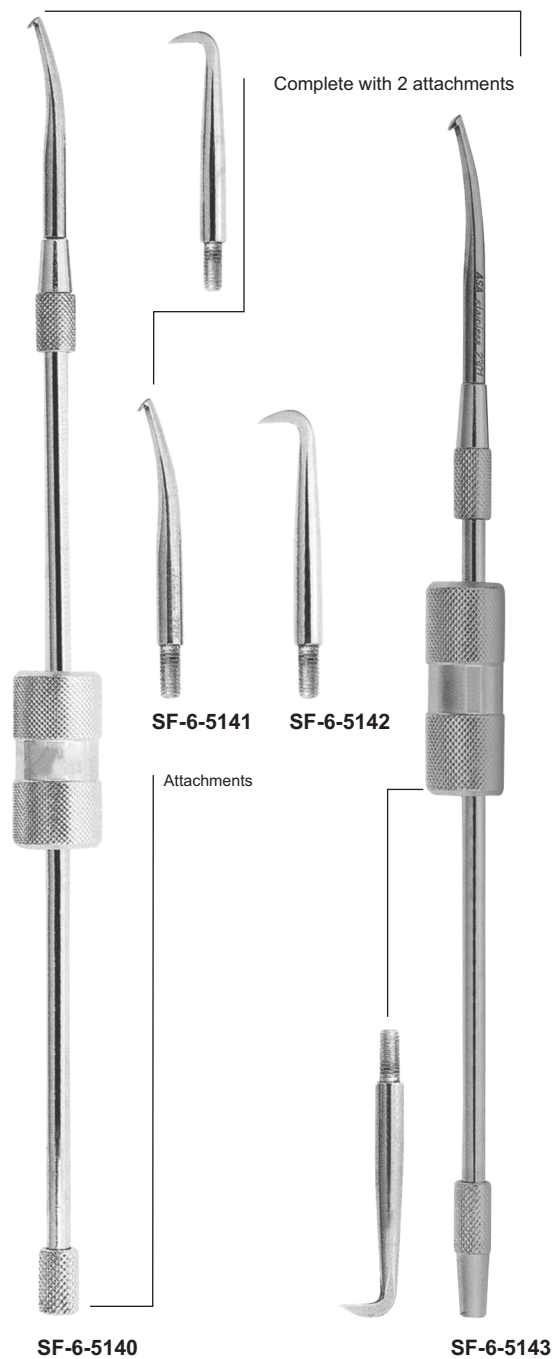
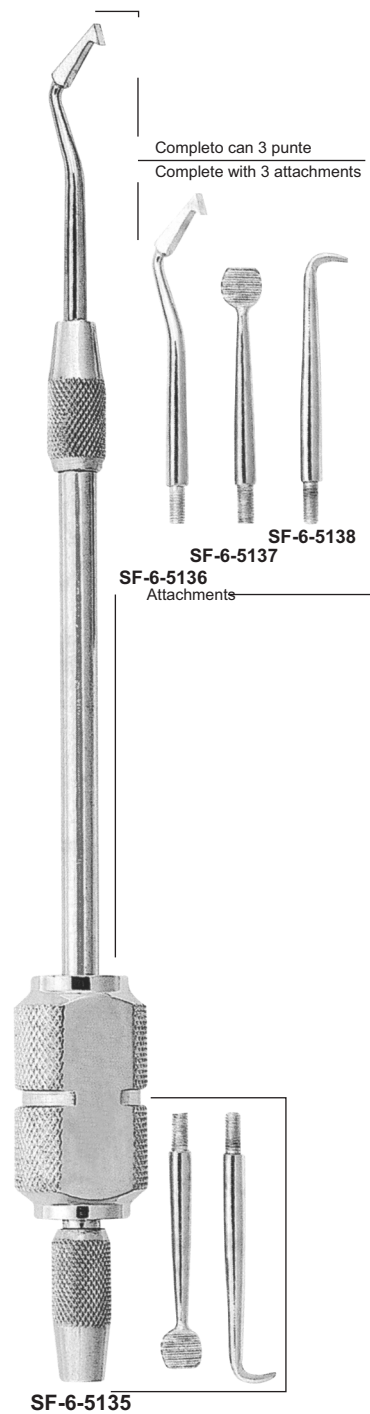



Universal "HM"  
12 cm, 4 3/4"

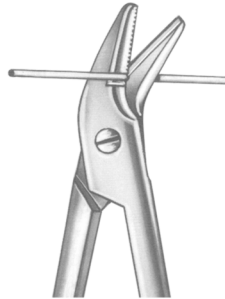

SF-6-5144

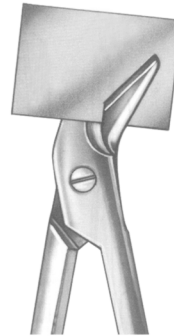

SF-6-5145



SF-6-5146  
Beebee  
10,5 cm, 4 1/8"

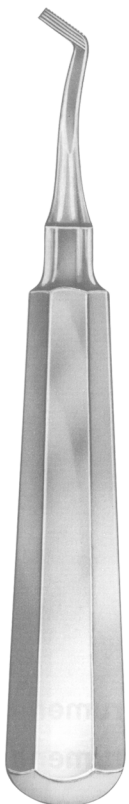

SF-6-5147  
Mershon



SF-6-5148  
Morell



SF-6-5149  
Morell



SF-6-5150  
Morell



SF-6-5151  
Morell



SF-6-5152  
Treyman

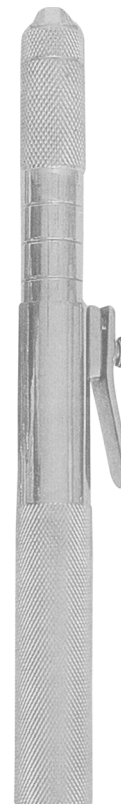

SF-6-5153  
Automatic Crown Remover  
With 2 Points



SF-6-5154



SF-6-5155

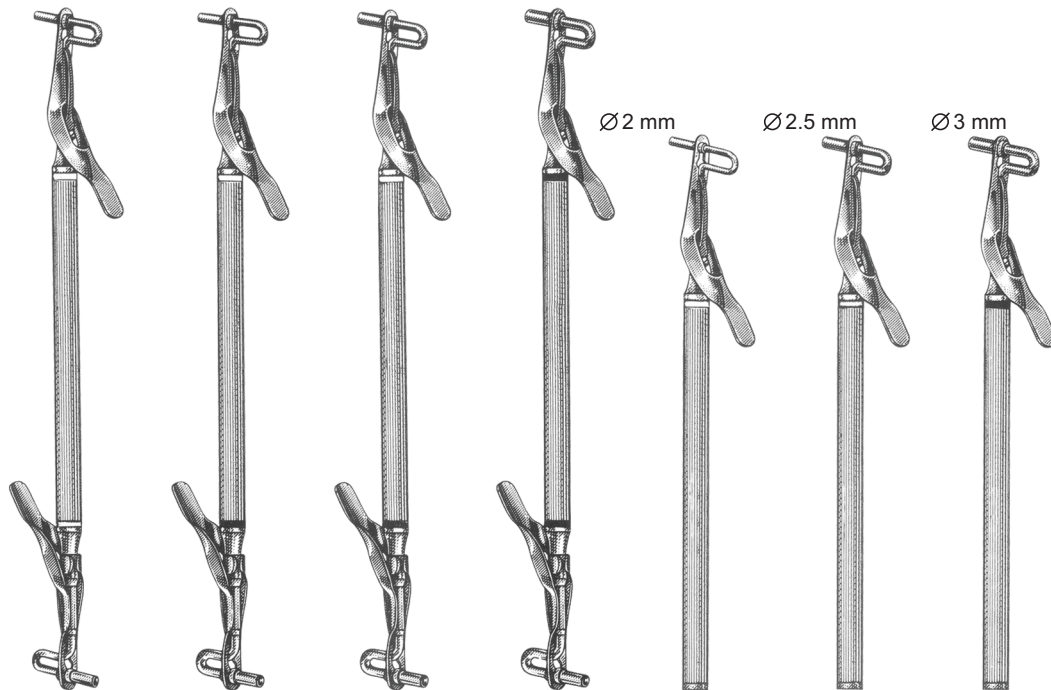

**SF-6-5156**  
Medium-Large  
20 cm

**SF-6-5157**  
Medium-Jumbo  
20 cm

**SF-6-5158**  
Large-Jumbo  
20 cm

**SF-6-5159**  
Jumbo-Jumbo  
20 cm

**SF-6-5160**  
Medium  
15.5 cm

**SF-6-5161**  
Large  
15.5 cm

**SF-6-5162**  
Jumbo  
15.5 cm

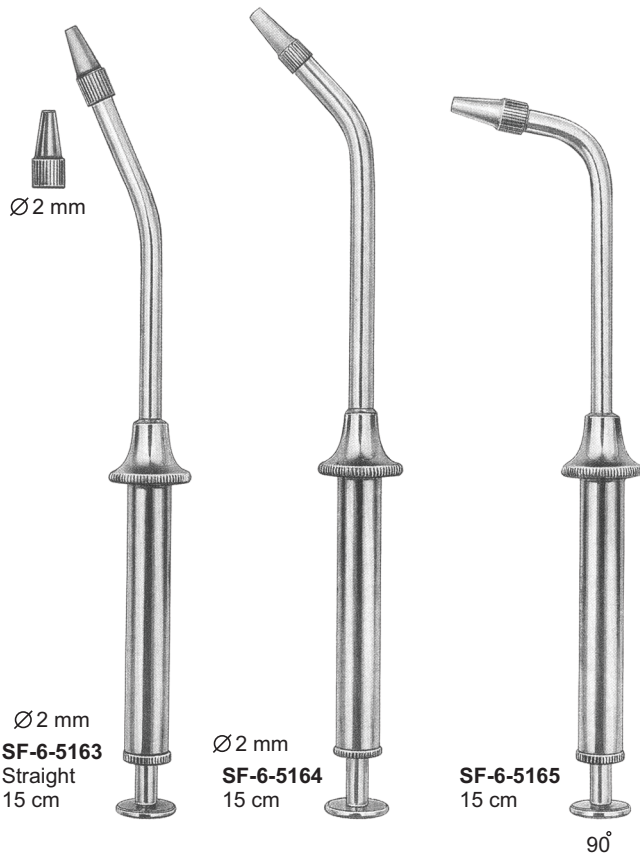

Ø 2 mm  
**SF-6-5163**  
Straight  
15 cm

Ø 2 mm  
**SF-6-5164**  
15 cm

**SF-6-5165**  
15 cm

90°

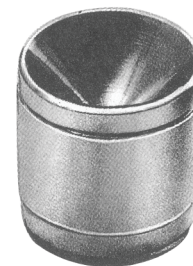

**SF-6-5166**  
Amalgam Well  
Non Skid Base  
Ø 3.5 mm

Page  
123

- Copper Ring Removing Plierspaper Articulator Forceps

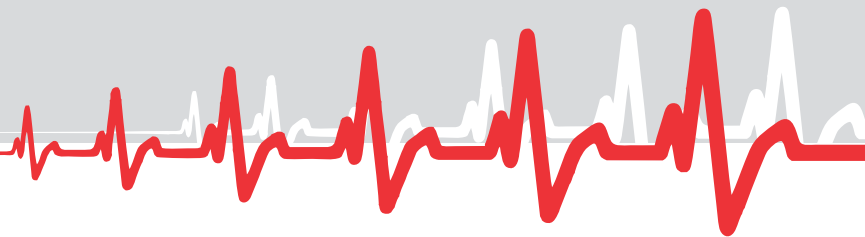

Copper ring removing pliers



**SF-6-5167**  
Bohm  
11,5 cm



**SF-6-5168**  
Bohm  
14,5 cm



**SF-6-5169**  
Furrer  
16 cm



**SF-6-5170**  
Furrer  
16 cm

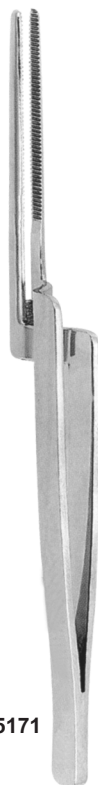

**SF-6-5171**  
Miller  
15 cm



**SF-6-5172**  
Miller  
15 cm



**SF-6-5173**  
Kelly  
14 cm



**SF-6-5174**  
Halstead-Mosquito  
12 cm



**SF-6-5175**  
Micro-Mosquito  
10 cm

Page  
124-127

- Rongeurs

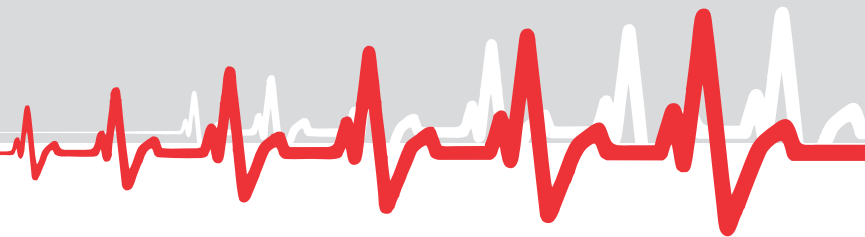

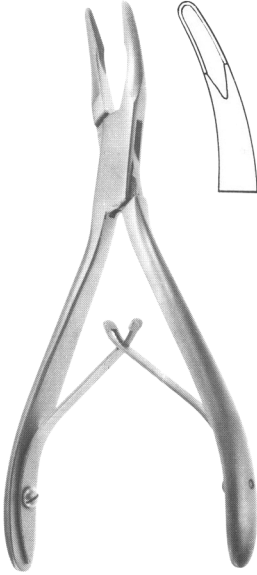

**SF-6-5176**  
Friedmann  
14 cm, 5 1/2"

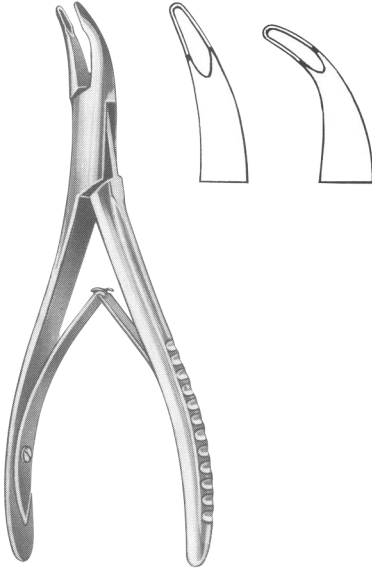

**SF-6-5177**  
14 cm, 5 1/2"

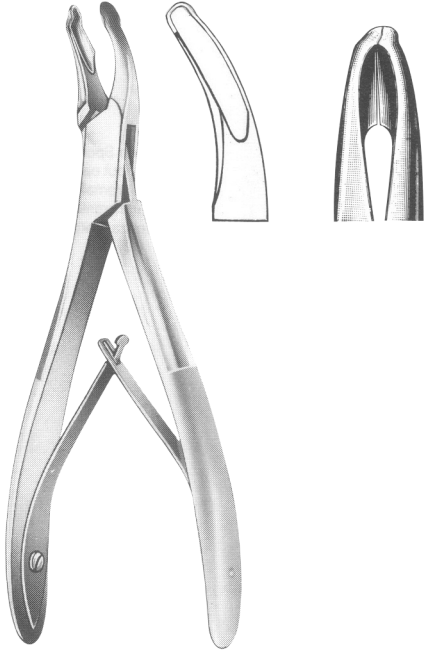

**SF-6-5178**  
Mead  
14 cm, 5 1/2"

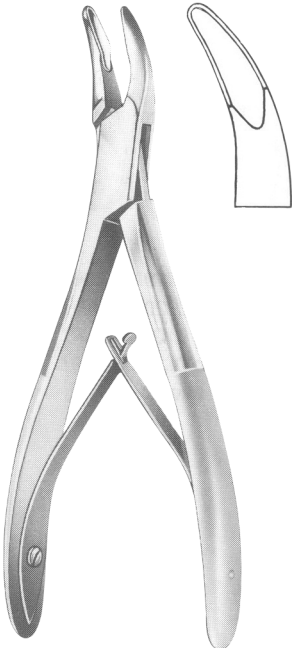

**SF-6-5179**  
Mead  
14 cm, 5 1/2"



**SF-6-5180**  
Mead  
17 cm, 6 3/4"

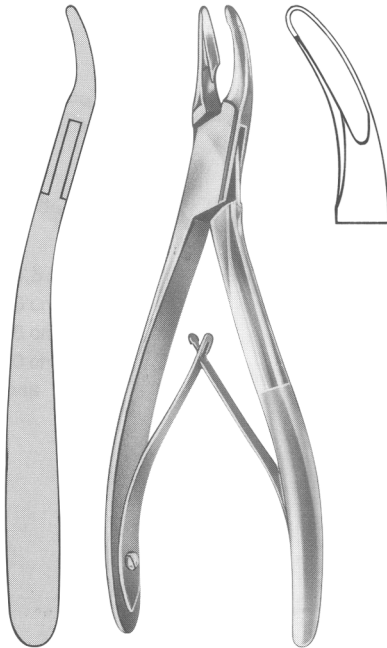

**SF-6-5181**  
Schell  
17 cm, 6 3/4"





**SF-6-5182**  
Luer  
15 cm



**SF-6-5183**  
Friedman  
14 cm



**SF-6-5184**  
Mini Friedman  
12 cm



**SF-6-5185**  
Goldman-Fax  
10 cm



**SF-6-5186**  
Blumenthal  
15 cm



**SF-6-5187**  
Blumenthal 45  
14,5 cm



**SF-6-5188**  
Blumenthal 90  
14 cm

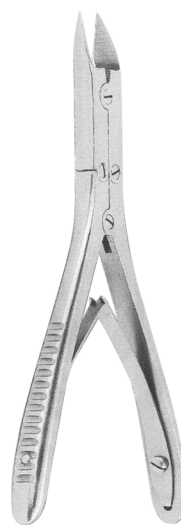

**SF-6-5189**  
Bohler  
15 cm



**SF-6-5190**  
Kerrison  
15 cm

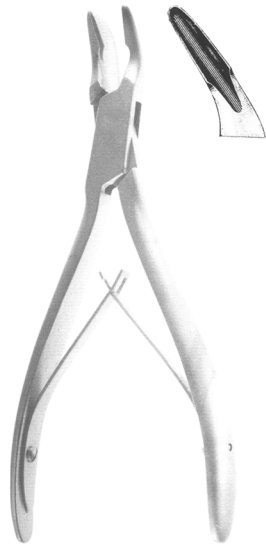

**SF-6-5191**  
Blumenthal  
16 cm, 6 1/4"

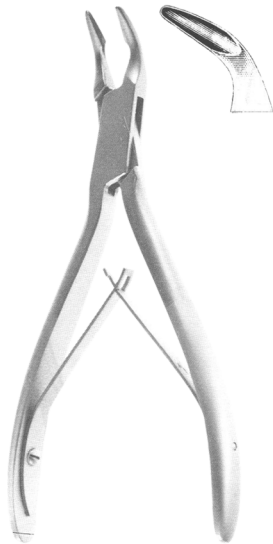

**SF-6-5192**  
Blumenthal  
16 cm, 6 1/4"

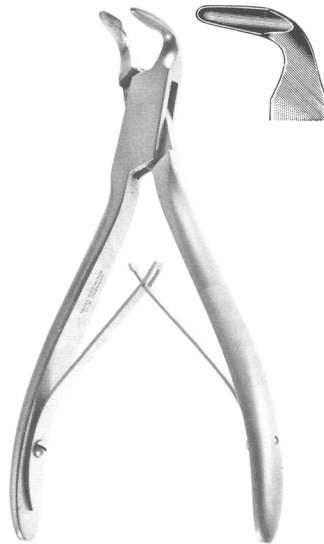

**SF-6-5193**  
Blumenthal  
16 cm, 6 1/4"

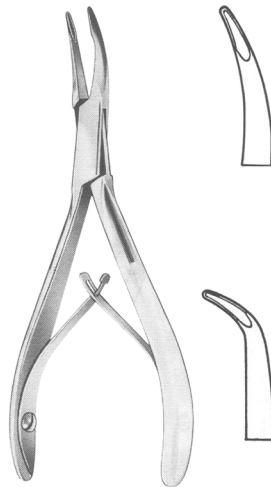

**SF-6-5194**  
Kleinert-Kutz  
14 cm, 5 1/2"

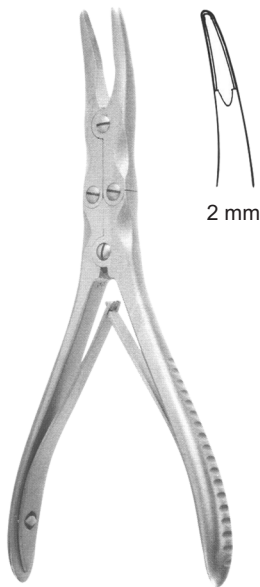

**SF-6-5195**  
Ruskin-Mini  
15 cm

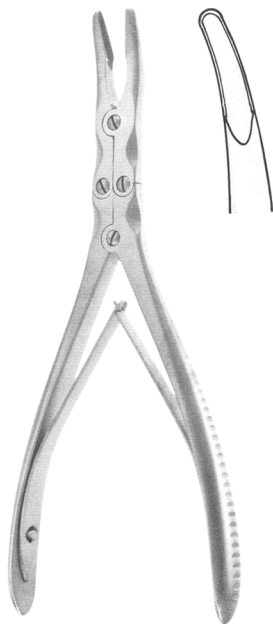

**SF-6-5196**  
Beyer  
18 cm, 7 1/8"

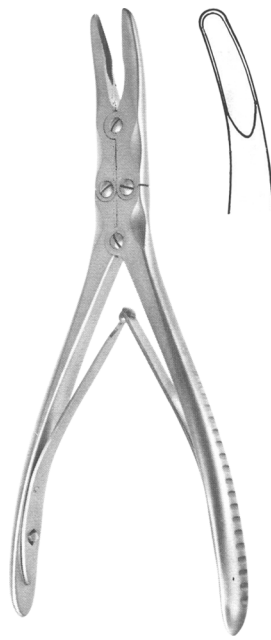

**SF-6-5197**  
Zaufal-Jansen  
18 cm, 7 1/8"

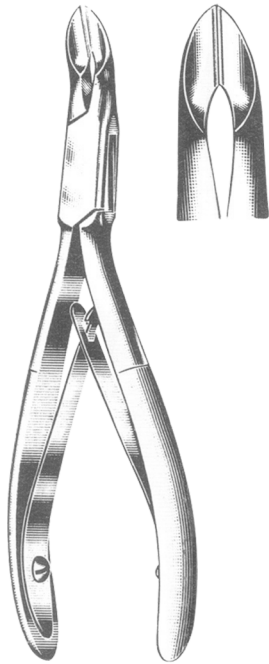

**SF-6-5198**  
Niro  
No. 5 S, 14 cm, 5 1/2"

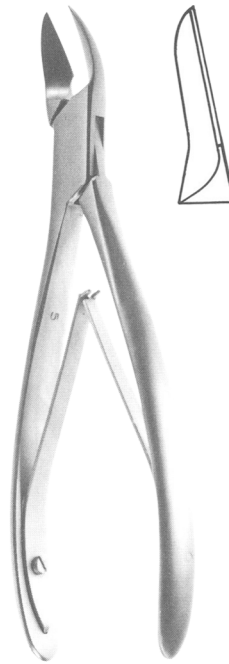

**SF-6-5199**  
Cleveland  
No. 5 S, 17 cm, 6 3/4"

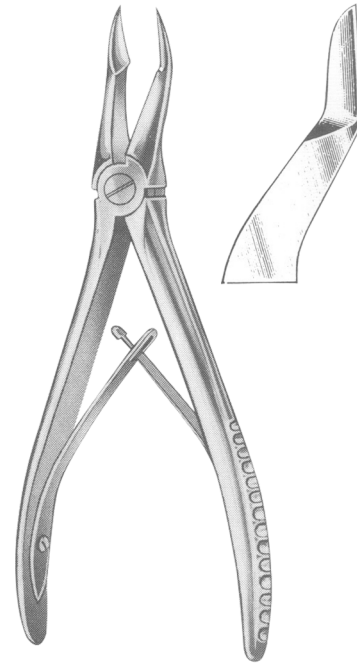

**SF-6-5200**  
No. 18, 15 cm, 6"

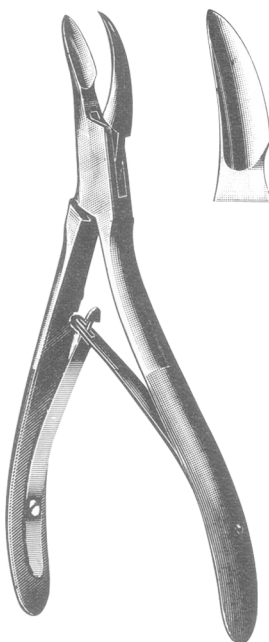

**SF-6-5201**  
Cleveland  
16 cm, 6 1/4"



**SF-6-5202**  
Gardner  
16 cm, 6 1/4"



**SF-6-5203**  
Liston-mini  
15 cm, 6"

Page  
128–129

- Bone Elevators, Bone Files and Chisels

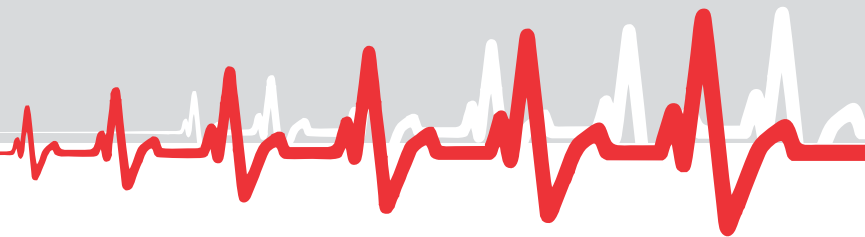

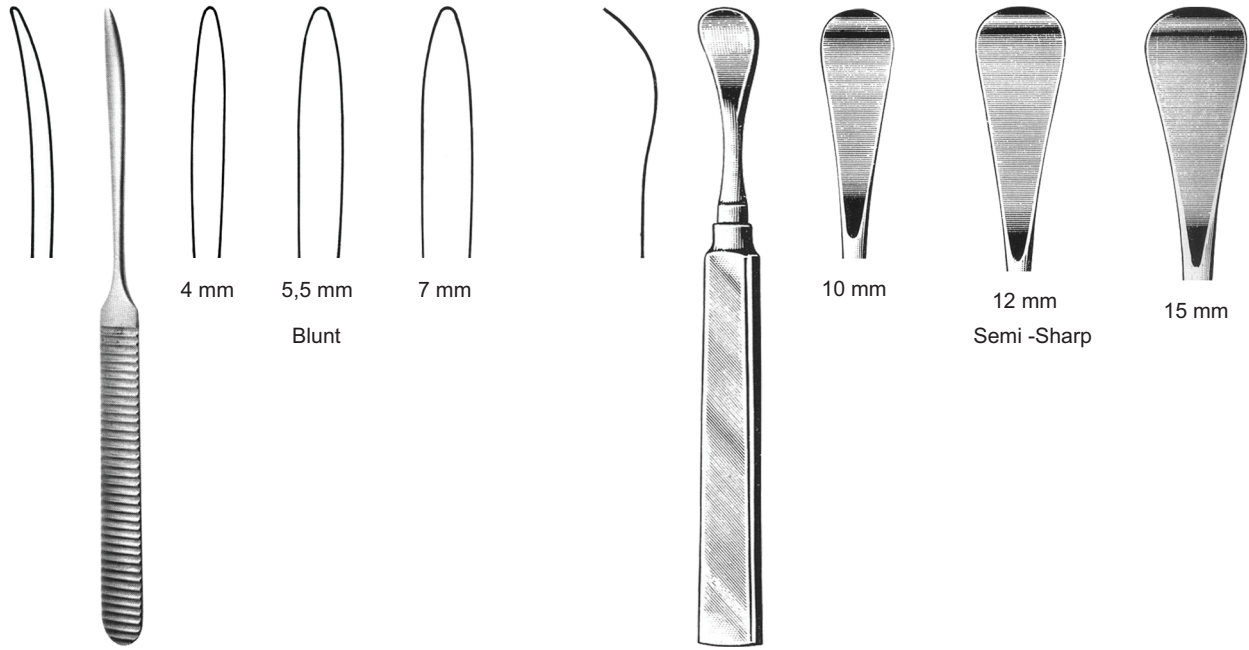

**SF-6-5204**  
Williger  
16 cm, 6 1/4"

**SF-6-5205**  
Henahan  
17 cm, 6 3/4"

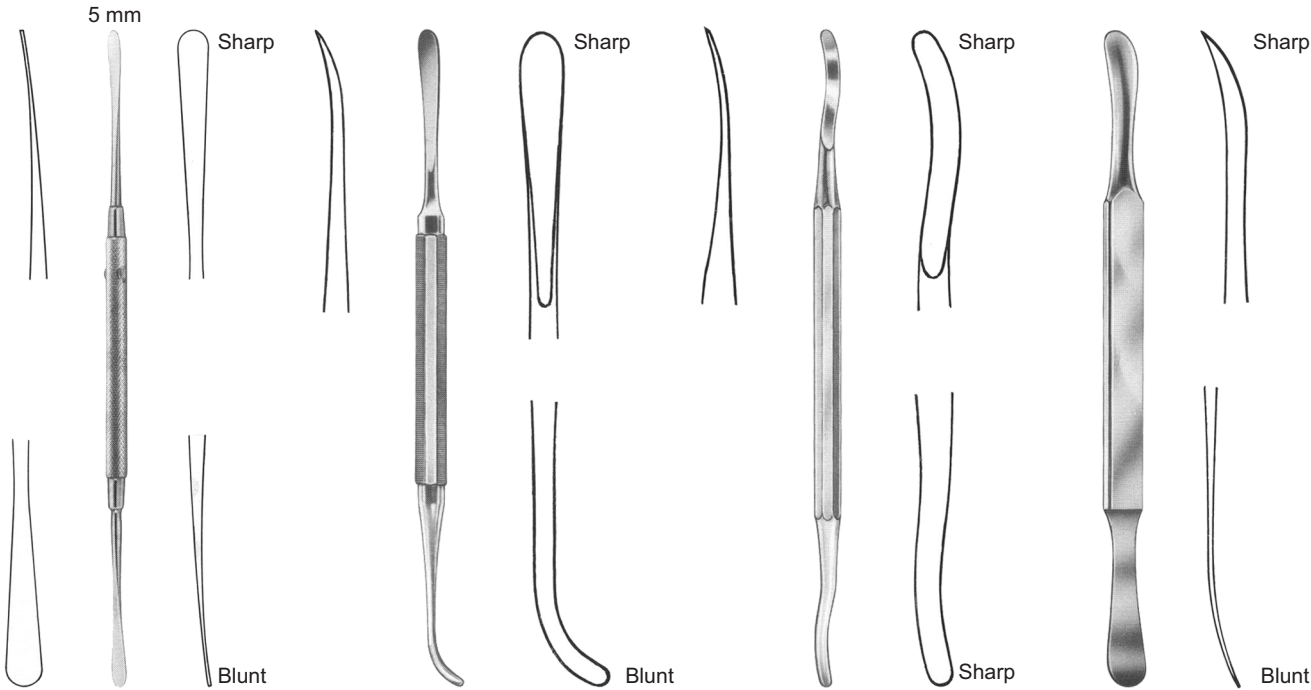

**SF-6-5206**  
Freer  
19 cm, 7 1/2"

**SF-6-5207**  
Bennet  
17 cm, 6 3/4"

**SF-6-5208**  
Seldin  
19 cm, 7 1/2"

**SF-6-5209**  
Seldin  
19,5 cm, 7 3/4"

# Bone Files and Chisels

[www.surgiforce.com](http://www.surgiforce.com)



**Buckley**  
15 cm, 6"

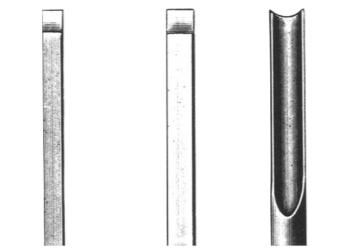

**SF-6-5210** No. 1 3mm  
**SF-6-5211** No. 2 4mm  
**SF-6-5212** No. 3 5mm

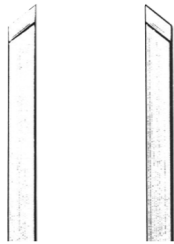

**SF-6-5213** No. 4 4mm  
**SF-6-5214** No. 5 4mm



**SF-6-5215**  
Killian  
16 cm, 6 1/4" 5 mm



**SF-6-5216**  
Killian-Claus  
16 cm, 6 1/4" 5 mm

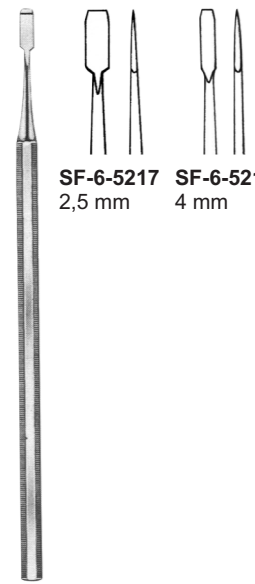

Obwegeser

**SF-6-5217** 2,5 mm  
**SF-6-5218** 4 mm



**SF-6-5219**  
Miller  
No.10C



**SF-6-5220**  
Miller  
No.11C



**SF-6-5221**  
Miller  
No.12C

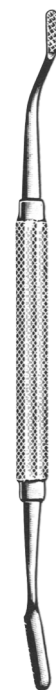

**SF-6-5222**  
Miller  
No.13C



## Page 130–151

- Pliers For Orthodontics
- Mouth Gags
- Tongue Depressors
- Lip and Cheek Retractors
- Implantology Instruments

Pinze per formare loops  
Loops forming pliers



**SF-7-5101**  
Adams

Adams pliers for bending wires up to 0,7mm. (.28").

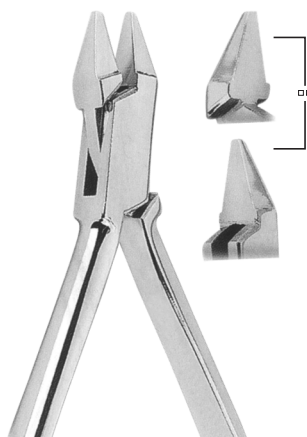

**SF-7-5102**  
Adams

Adams pliers for bending wires up to 0,7mm. (.28").

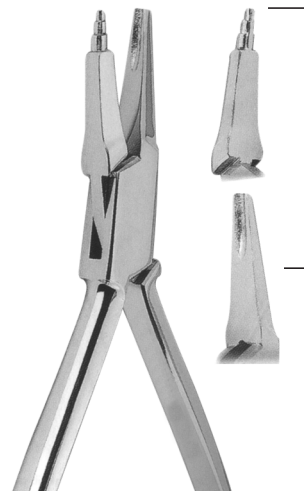

**SF-7-5103**  
Adams

Tweed loop forming pliers. For forming loop in wires up to 0,56 mm. (.22").



**SF-7-5104**  
Adams

Aderer three jaws bending pliers. For wires up to 0,7 mm. (.28").



**SF-7-5105**  
Adams

Aderer three jaws bending pliers. For wires upto 0,7 mm. (.28").



## Ligature Cutter Pliers



**SF-7-5106**

Micro-miniature light wire cutter. It cuts soft ligature wires. For use in caso of limited access. Caution: maximum cutting capacity: soft ligature wire up to 0,30 mm. (.012").



**SF-7-5107**

Wire cutter. For ligature wires and pins. It is strong enough to bend archwire ends after distal cutting. Maximum cutting capacity up to 0,56 x 0,7 mm. (.022" x .028").

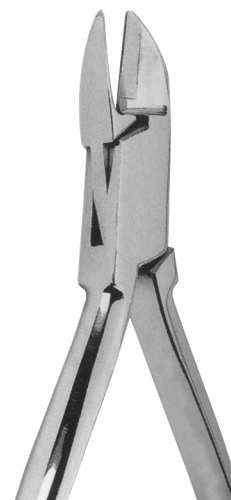

**SF-7-5108**

Wire cutter. For ligature wires and pins. It is strong enough to bend archwire ends after distal cutting. Maximum cutting capacity: up to 0,9 mm. (.036").

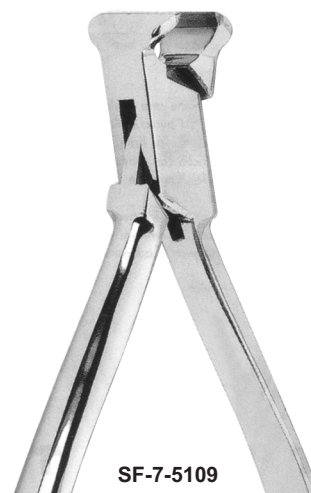

**SF-7-5109**

Wire cutter. For ligature wires and pins. It is strong enough to bend archwire ends after distal cutting. Maximum cutting capacity: up to 1,5 mm. (.044").

Pinze per formare laboratorio  
Laboratory pliers



SF-7-5110

Flat nose pliers with smooth beaks for bending wires up to 0,7 mm. (.028").



SF-7-5111

Bending wires up to 0,7 mm. (.028").



SF-7-5112

Bending wires up to 0,7 mm. (.028").

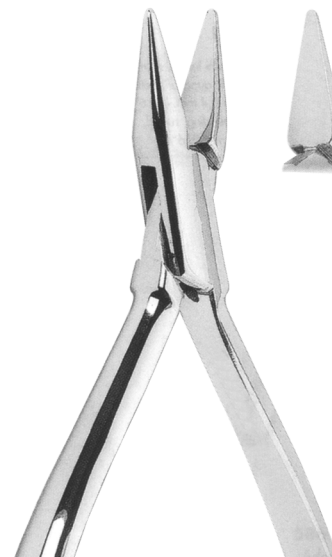

SF-7-5113

Bending wires up to 0,7 mm. (.028").





**SF-7-5114**  
Nance

Nance loop closing pliers, for bending of stop loops and special for Adams' clasps. Wires up to 0,7 mm. (.028").



**SF-7-5115**  
Nance

Universal pliers for bending wires up to 0,9 mm. (.035") or cutting up to 0,7 mm. (.028").

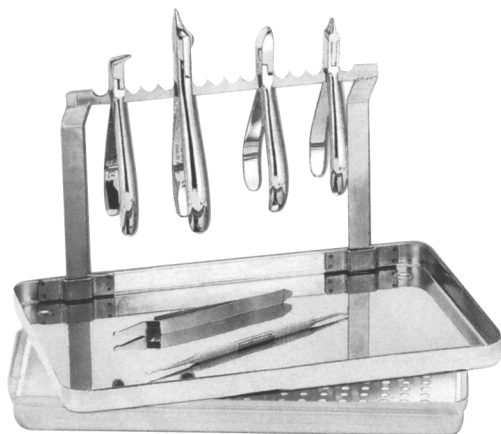

**SF-7-5116**

Stainless steel pliers tray standard dimensions



**SF-7-5117**  
Universal

Universal pin roughening, cutting and bending pliers. For wires up to 0,9 mm. (.035"). Will cut wires up to 0,7 mm. (.028").

Utility and specialty pliers



**SF-7-5118**  
Reynolds

Reynolds contouring pliers.



**SF-7-5119**  
Reynolds

Lingual arch pliers used to form double and triple back bends in 0,7 mm (.028") or 0,9 mm (.035") wire for insertion in lingual sheaths.



**SF-7-5120**  
Weingart

Weingart pliers with serrated points.

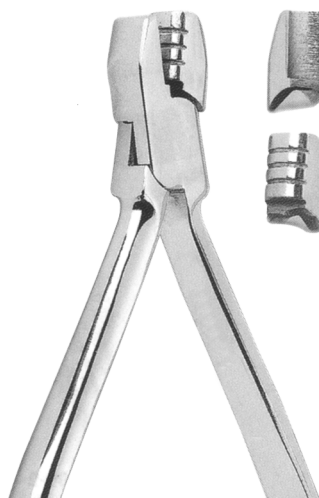

**SF-7-5121**  
De La Rosa

De La Rosa arch forming pliers. Designed to form and contour arch wires on round or rectangular wire. The beak has grooves of 0,4 mm (.016"), 0,46 mm (.018") and 0,56 mm (.022").



**SF-7-5122**  
De La Rosa

Arch forming pliers with a non grooved contouring surface the forming of precise arches.

## Loop formare pliers



**SF-7-5123**  
Waldsachs

Waldsachs universal pliers for bending wires up to 1,0 mm. (.039") or cutting up to 0,7 mm. (.028").



**SF-7-5124**

Round and Concave pliers for loop forming and bending of thin round and square wires up to 0,5 mm. (.020").

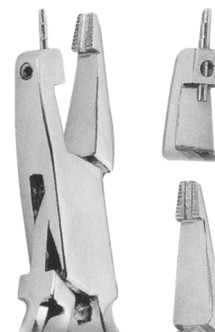

**SF-7-5125**  
Tweed

Tweed loop Forming Pliers. For round or rectangular wires up to 0,56 x 0,7 mm. (.022" x .028"). Replaceable cylindrical beak with three sizes: 1,15 mm. (.045), 1,50 mm. (.059"), 1,90 mm. (.075"). Concave beak with slight parallel serrations, to keep the wire in proper position.

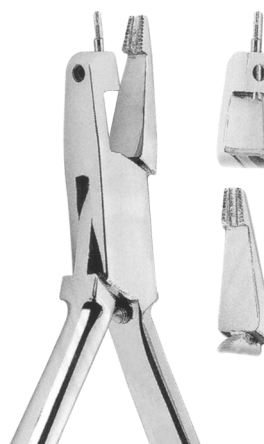

**SF-7-5126**  
Tweed

Tweed Loop Forming Pliers. For making perfect Omega Loops with round or rectangular wires up to 0,56 x 0,7 mm. (.022" x .028"). The concave beak is exactly the same as pliers 5809-1

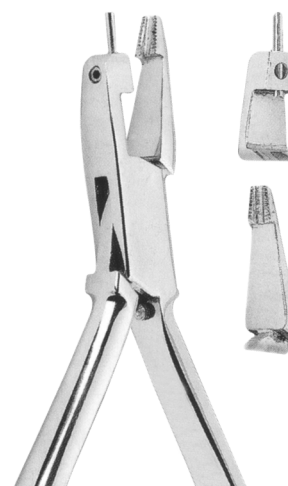

**SF-7-5127**  
Tweed

Single diameter loop forming pliers. Wire up to 0,56 x 0,7 mm. (.022" x 0.28"). Replaceable concave beak has only one diameter section of 1,50 mm. (.059").

**Distal end cutters**



**SF-7-5128**

Distal end cutter -safety hold- a precision cutter designed for distal arch cutting in the patient's mouth. It cuts hard wires end holds the loose distal end preventing any damaging of oral tissue. Maximum cutting capacity rectangular wires up to 0,56 x 0,7 mm. (.022" x .020").



**SF-7-5129**

Micro- distal end cutter - safety hold-. Similar to 3227



**SF-7-5130**

Direct bonding bracket remover (wide). The removal grip firmly for easy incisal-gingival (vertical) use or, if needed, for mesial-distal (horizontal) use with the same ease.

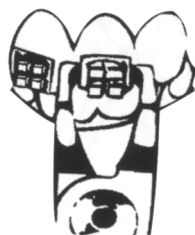

**SF-7-5131**

Direct bond attachment remover (angled). For removing all bonded attachments. May be used mesial-distal-horizontal) or incisal-gingival (vertical) in anterior areas. Angled perfectly for easy access to difficult posterior areas.

## Bird beak pliers



**SF-7-5132**

Wire bending pliers. For wires up to 0,9 mm. (.036").

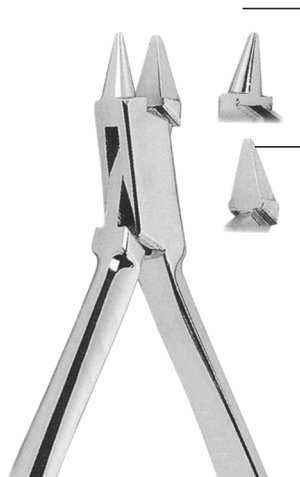

**SF-7-5133**

Bird Beak Angle pliers for bending round, square or rectangular wire up to 0,7 mm. (.028").



**SF-7-5134**

Double rounded jaw wire bending pliers. For wires up to 0,7 mm. (.028").



**SF-7-5135**

Bird beak pliers for bending round, square or rectangular wire up to 0,7 mm. (.028"). With cutter.

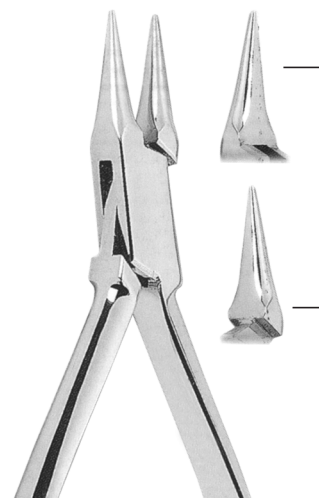

**SF-7-5136**

Double rounded jaw wire bending pliers. For wires up to 0,7 mm. (.028").



**SF-7-5137**  
USA Model  
125 mm



**SF-7-5138**  
Waldron  
125 mm

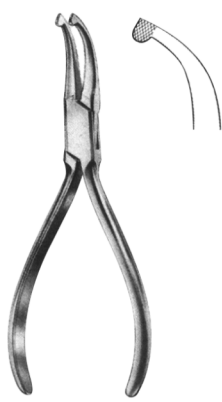

**SF-7-5139**  
How  
140 mm



**SF-7-5140**  
How  
145 mm

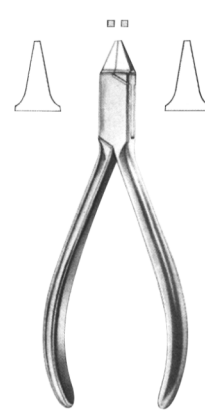

**SF-7-5141**  
Adams  
125 mm

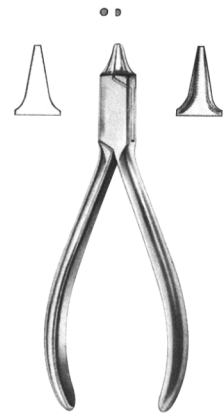

**SF-7-5142**  
Angle  
125 mm



**SF-7-5143**  
young  
130 mm



**SF-7-5144**  
Nance  
130 mm



**SF-7-5145**  
Weingart  
140 mm



**SF-7-5146**  
Johnson  
130 mm



**SF-7-5147**  
Mc Kellops  
155 mm

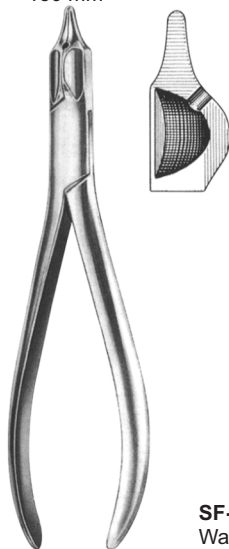

**SF-7-5148**  
Universal  
150 mm

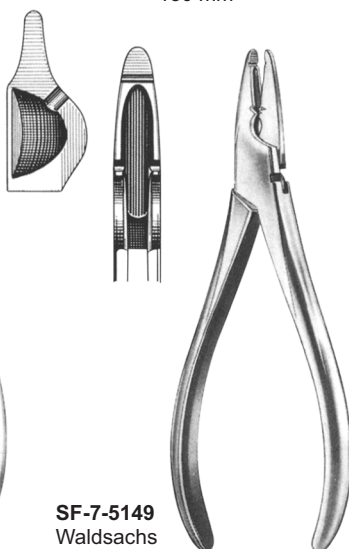

**SF-7-5149**  
Waldsachs  
155 mm

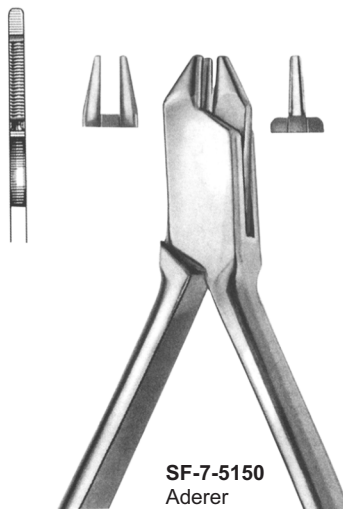

**SF-7-5150**  
Aderer  
125 mm



**SF-7-5151**  
Nance  
130 mm



# Pliers for Othodontics and Prosthetics

[www.surgiforce.com](http://www.surgiforce.com)



**SF-7-5152**  
Langenbeck  
140 mm



**SF-7-5153**  
Langenbeck  
130 mm



**SF-7-5154**  
Langenbeck  
130 mm



**SF-7-5155**  
Peeso  
125 mm



**SF-7-5156**  
Goslee  
125 mm

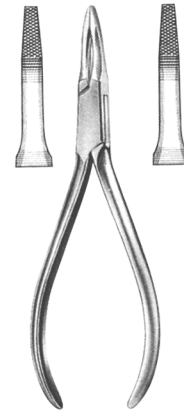

**SF-7-5157**  
Fischer  
140 mm

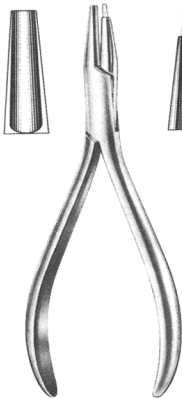

**SF-7-5158**  
Andresen  
130 mm

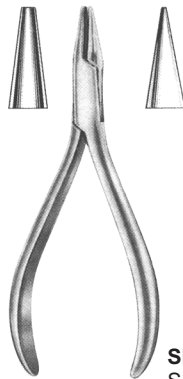

**SF-7-5159**  
Schwarz  
130 mm

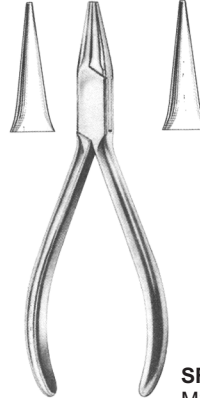

**SF-7-5160**  
MSY  
130 mm

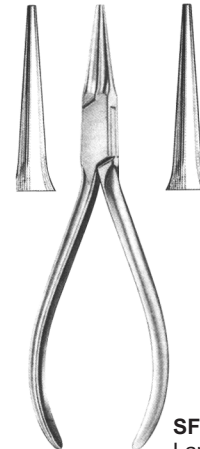

**SF-7-5161**  
Langenbeck  
125 mm



**SF-7-5162**

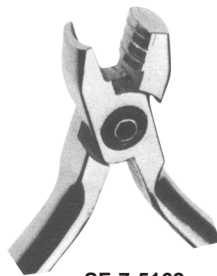

**SF-7-5163**

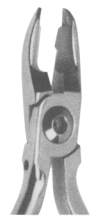

**SF-7-5164**



**SF-7-5165**



**SF-7-5166**



**SF-7-5167**



**SF-7-5168**



SF-7-5169

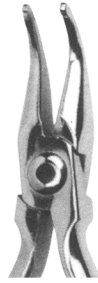

SF-7-5170

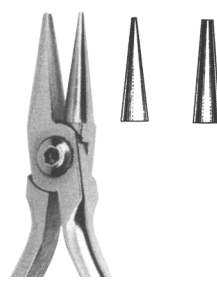

SF-7-5171

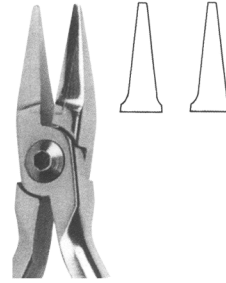

SF-7-5172

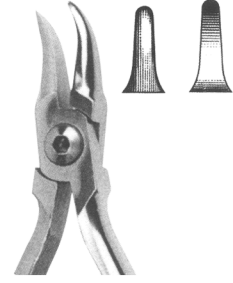

SF-7-5173

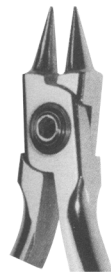

SF-7-5174

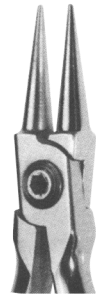

SF-7-5175

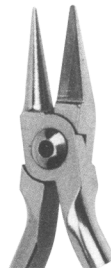

SF-7-5176

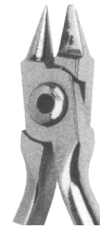

SF-7-5177



SF-7-5178

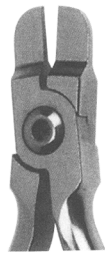

SF-7-5179

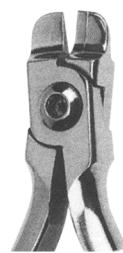

SF-7-5180



SF-7-5181

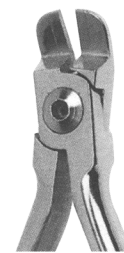

SF-7-5182

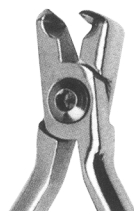

SF-7-5183

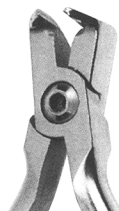

SF-7-5184

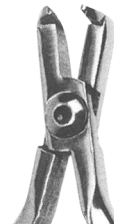

SF-7-5185

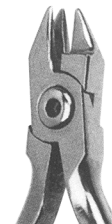

SF-7-5186

# Mouth Gags

[www.surgiforce.com](http://www.surgiforce.com)



Molt  
**SF-7-5187** 10 cm  
**SF-7-5188** 11 cm  
**SF-7-5189** 14 cm



**SF-7-5190** 16 cm  
**SF-7-5191** 19 cm  
 Roser-König



**SF-7-5192**  
 Denhardt  
 13 cm



**SF-7-5193**  
 Fergusson - Ackland  
 14.5 cm



**SF-7-5194**  
 Heister  
 Maunder Wood  
 9.5 cm



**SF-7-5195**  
 Obwegeser 11 cm  
 Spreading 47 mm



**SF-7-5196**  
 Heister  
 13 cm



**SF-7-5197** Small  
**SF-7-5198** Medium  
**SF-7-5199** Large  
 Cheek Retractor

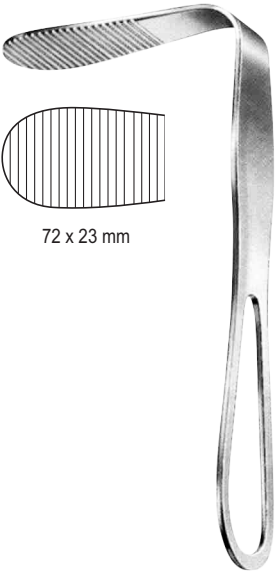

72 x 23 mm

**SF-7-5200**  
Hartmann  
15 cm



**SF-7-5201**  
Doyen Tongue Spatula  
13.5 cm



**SF-7-5202**  
14.5 cm



**SF-7-5203**  
18 cm



**SF-7-5204**  
Bruenings  
19 cm

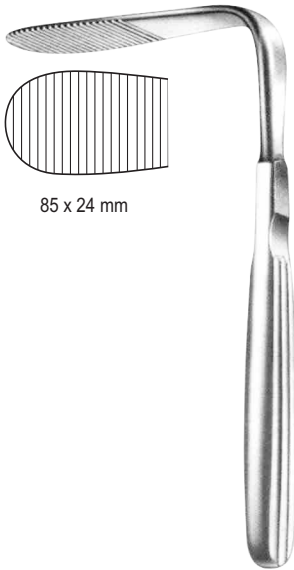

85 x 24 mm

**SF-7-5205**  
Tobold  
15 cm

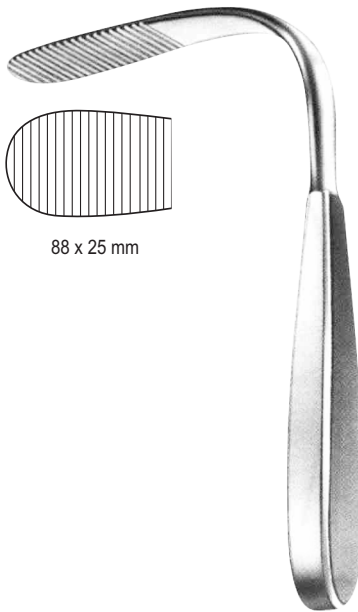

88 x 25 mm

**SF-7-5206**  
Tobold  
16 cm

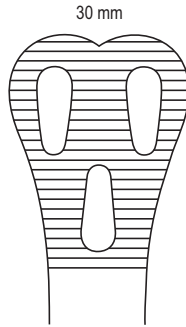

30 mm

**SF-7-5207**  
14 cm

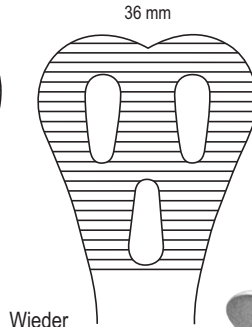

36 mm

Wieder

**SF-7-5208**  
15 cm

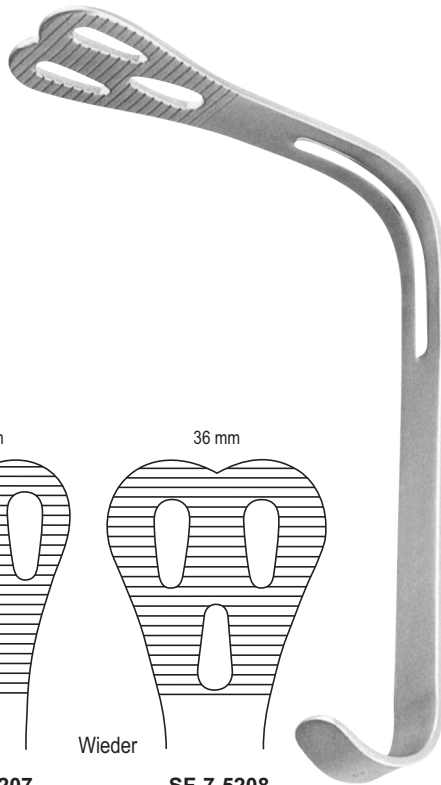

# Lip and Cheek Retractors

[www.surgiforce.com](http://www.surgiforce.com)



**SF-7-5209**  
Obwegeser Chin  
Retractor  
16.5 cm



Obwegeser 16 cm  
**SF-7-5210** 8 mm  
**SF-7-5211** 10 mm



**SF-7-5212** 43 x 11 mm  
**SF-7-5213** 57 x 11 mm  
**SF-7-5214** 83 x 16 mm



35 x 11 mm

**SF-7-5215**  
Obwegeser  
Spina-nasalis retractor  
22 cm



72 x 11 mm

**SF-7-5216**  
Obwegeser  
Ramus retractor for  
separation of ramus & tissue  
22 cm



**SF-7-5217**  
Simplex  
10.5 cm

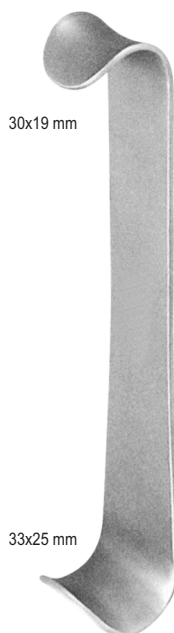

30x19 mm

33x25 mm

**SF-7-5218**  
Kilner  
15 cm



**SF-7-5219**  
Minnesota  
14 cm



**SF-7-5220**  
Cawood-Minnesota  
15 cm



**SF-7-5221**  
Austin



**SF-7-5222**  
Hilger  
Fits any simple stem mouth mirror handle

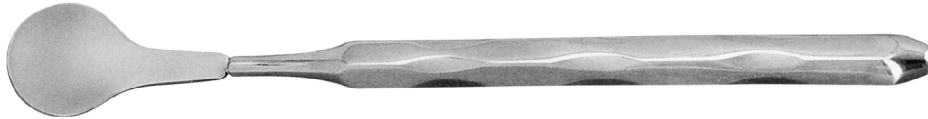

**SF-7-5223**  
Hilger  
with handle

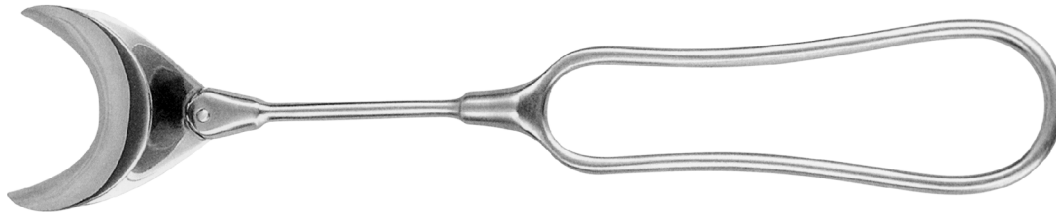

**SF-7-5224**  
Max  
20 cm

Finger protectors



Langenbeck

**SF-7-5225** Small  
**SF-7-5226** Medium  
**SF-7-5227** Large

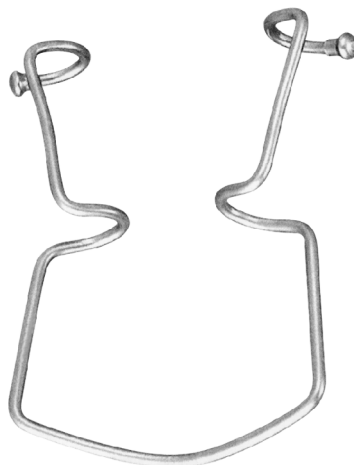

**SF-7-5228**  
Oringer  
11.5 cm

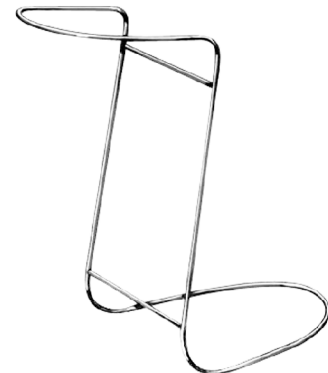

**SF-7-5229**  
Obwegeser Cheek Retractor  
12cm

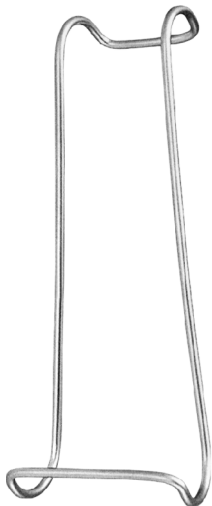

**SF-7-5230**  
Columbia  
14.5 cm



Sternberg

**SF-7-5231** 12 cm  
**SF-7-5232** 14 cm  
**SF-7-5233** 15 cm



Vestibulum  
**SF-7-5234**



**SF-7-5235**  
Max

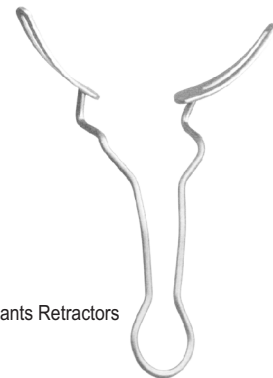

Implants Retractors

**SF-7-5236**  
Max

# Retractors

[www.surgiforce.com](http://www.surgiforce.com)

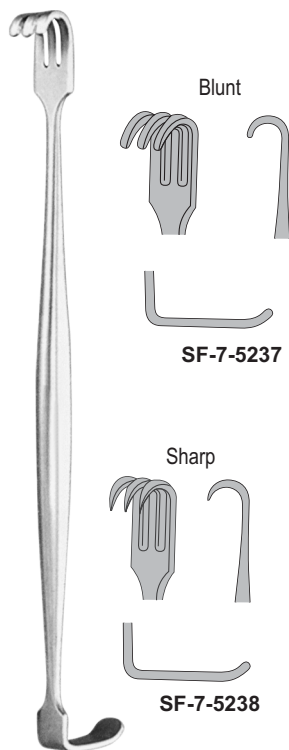

Blunt

SF-7-5237

Sharp

SF-7-5238

Senn-Miller  
16 cm

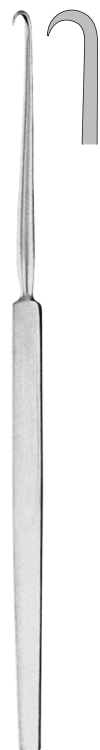

Sharp

SF-7-5239

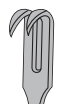

SF-7-5240



SF-7-5241



SF-7-5242

Max  
16 cm

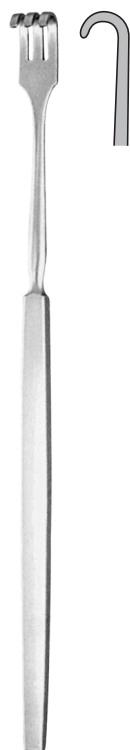

Blunt

SF-7-5243

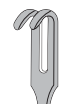

SF-7-5244



SF-7-5245



SF-7-5246

Max  
16 cm

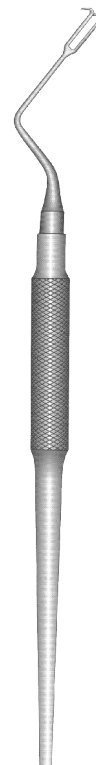

Kirkland  
Gum & Tissue  
Retractors



SF-7-5247  
Fig. 23 K



SF-7-5248  
Fig. 24 K



SF-7-5249  
Fig. 27 K



SF-7-5250  
Fig. 28 K



SF-7-5251  
Collin Tongue holding forceps  
17 cm



SF-7-5254  
Rubber Pad pair

Young Tongue holding forceps  
SF-7-5252 15 cm  
SF-7-5253 17 cm



SF-7-5255  
Farabeuf 12 cm  
Pair



SF-7-5256  
Parker-Langenbeck 21 cm  
Pair

Osteotomes



15.5 cm

# 1	Diam.
0	Ø 1.60
7.5	Ø 1.80
10	Ø 2.00
13.5	Ø 2.40
15.5	Ø 3.60

# 1  
Ø 1.6 mm



**SF-7-5257**  
15.5 cm

# 2	Diam.
0	Ø 1.90
7.5	Ø 2.20
10	Ø 2.35
13.5	Ø 3.30
15.5	Ø 3.40
23.5	Ø 4.50

# 2  
Ø 1.9 mm



**SF-7-5258**  
15.5 cm

# 3	Diam.
0	Ø 2.80
7.5	Ø 3.20
10.5	Ø 3.35
13.5	Ø 3.60
21	Ø 4.40

# 3  
Ø 2.8 mm



**SF-7-5259**  
15.5 cm

# 4	Diam.
0	Ø 3.10
7.5	Ø 3.70
10.5	Ø 3.90
15.5	Ø 4.30

# 4  
Ø 3.10 mm



**SF-7-5260**  
15.5 cm

# 5	Diam.
0	Ø 3.90
10	Ø 5.00
13	Ø 5.20
20.5	Ø 6.30

# 5  
Ø 3.90 mm



**SF-7-5261**  
15.5 cm

# 6	Diam.
0	Ø 5.50
10	Ø 6.20
13	Ø 6.30

# 6  
Ø 5.50 mm



**SF-7-5262**  
15.5 cm

# 1	Diam.
0	Ø 1.50
5	Ø 1.90
8	Ø 2.20
10	Ø 2.40
12	Ø 2.60
14	Ø 2.80

# 1  
Ø 1.5 mm



**SF-7-5263**  
15.5 cm

# 2	Diam.
0	Ø 2.10
5	Ø 2.60
8	Ø 2.80
10	Ø 3.00
12	Ø 3.20
14	Ø 3.40

# 2  
Ø 2.1 mm



**SF-7-5264**  
15.5 cm

# 3	Diam.
0	Ø 2.60
5	Ø 3.00
8	Ø 3.30
10	Ø 3.50
12	Ø 3.70
14	Ø 3.90

# 3  
Ø 2.6 mm



**SF-7-5265**  
15.5 cm

# 4	Diam.
0	Ø 3.00
5	Ø 3.50
8	Ø 3.80
10	Ø 4.00
12	Ø 4.20
14	Ø 4.40

# 4  
Ø 3.0 mm



**SF-7-5266**  
15.5 cm

# 5	Diam.
0	Ø 3.50
5	Ø 3.90
8	Ø 4.20
10	Ø 4.40
12	Ø 4.60
14	Ø 4.80

# 5  
Ø 3.5 mm



**SF-7-5267**  
15.5 cm

Ø 2.8 mm



**SF-7-5268**  
15.5 cm

Spelling Straight  
Bone Pusher

Ø 3.5 mm



**SF-7-5269**  
15.5 cm

Ø 4.2 mm



**SF-7-5270**  
15.5 cm



## Osteotomes

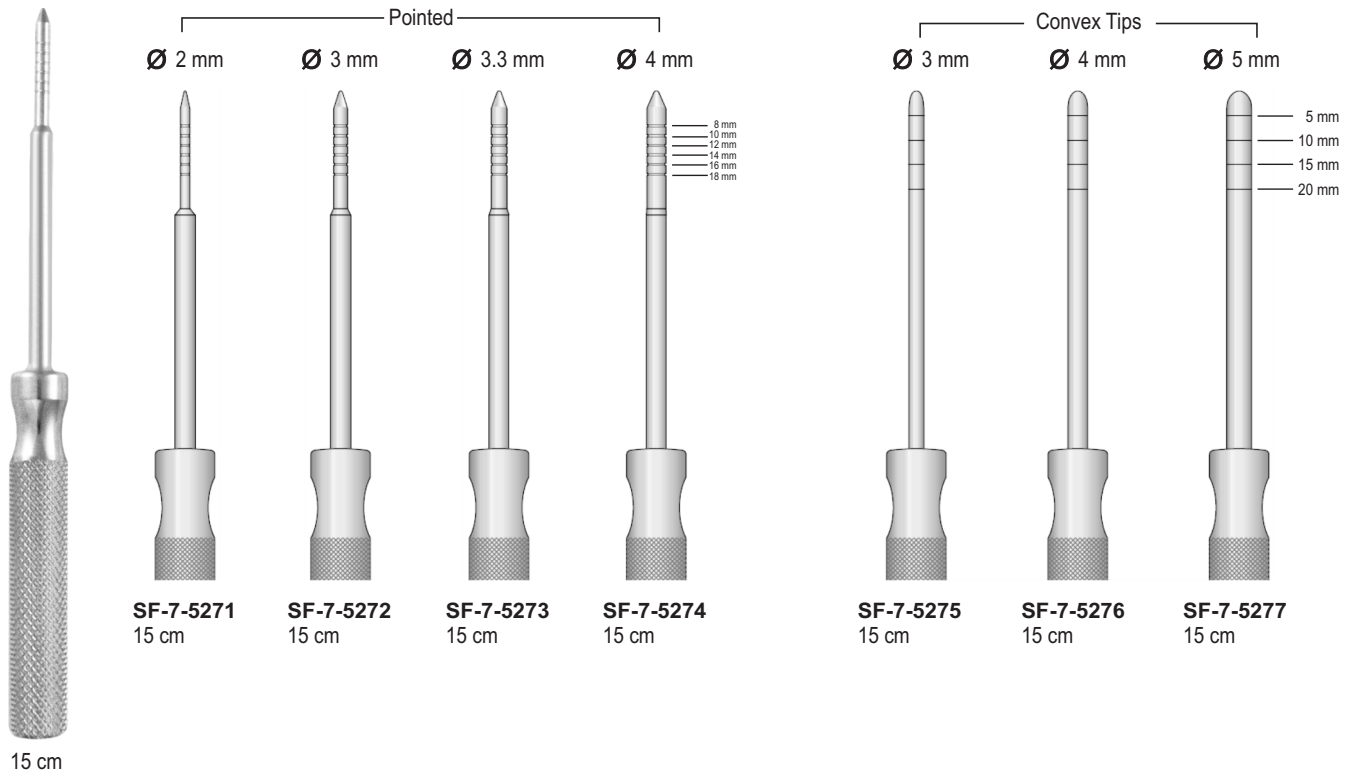

## Convex Tips

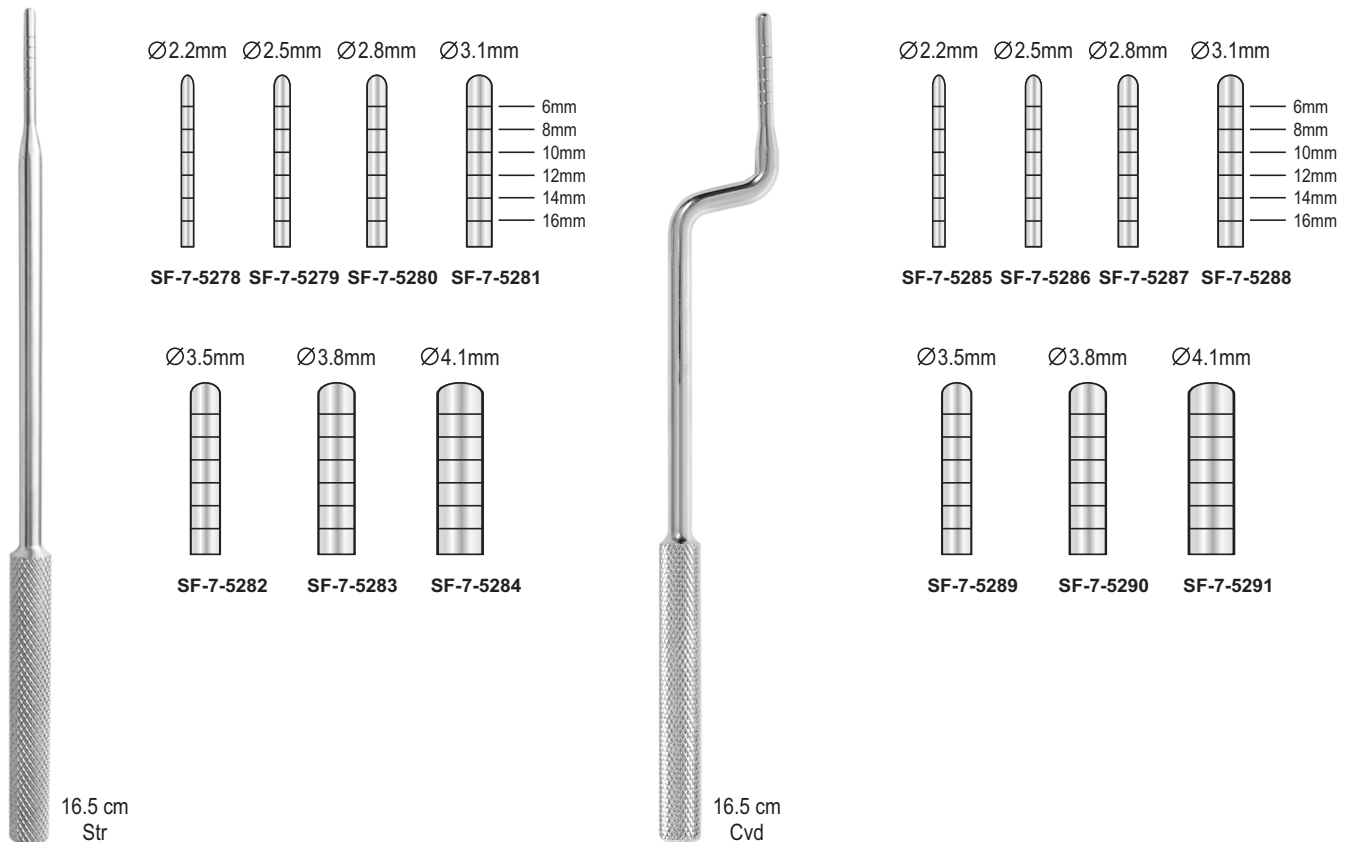

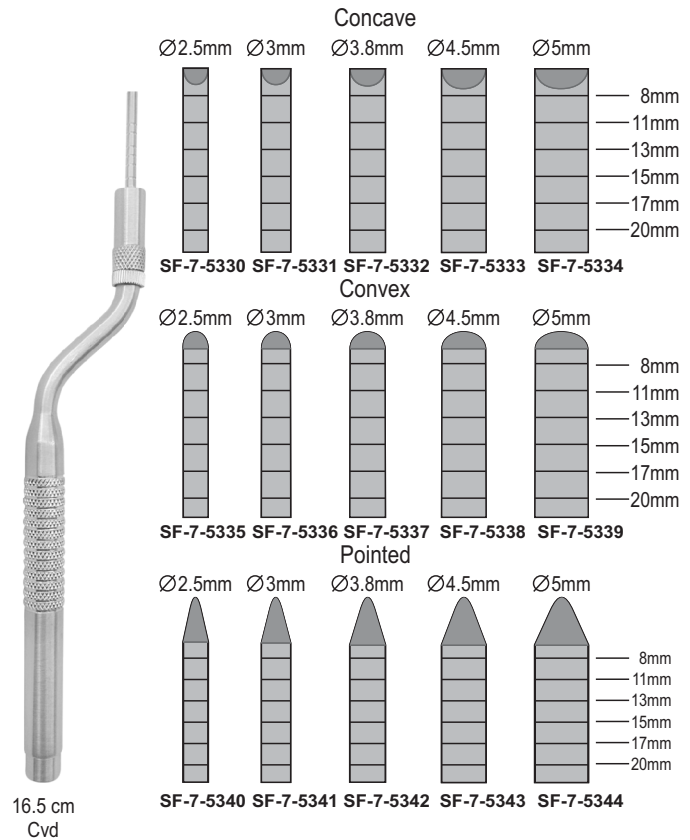
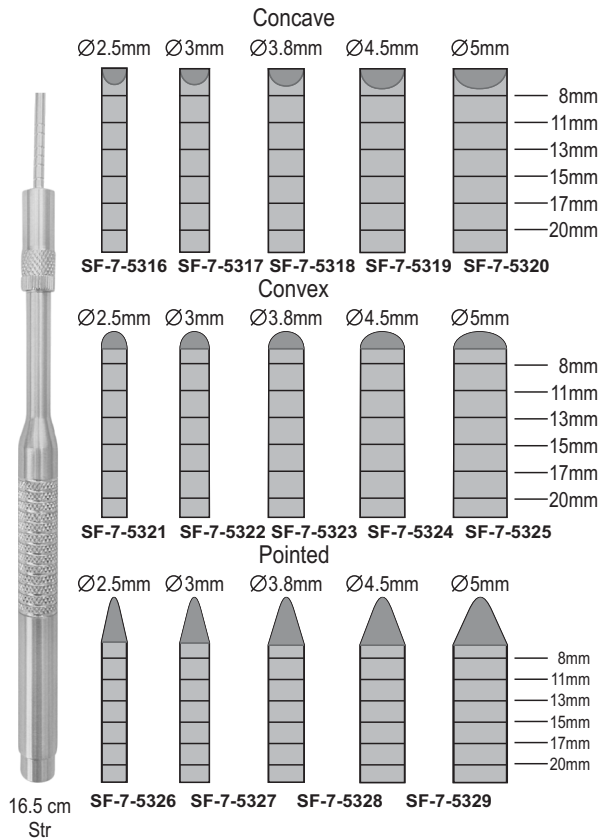
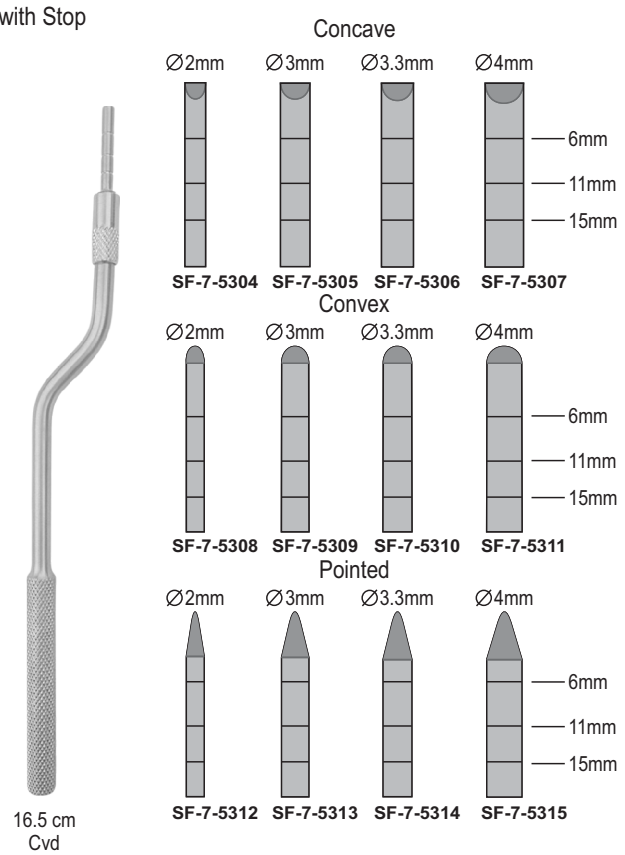
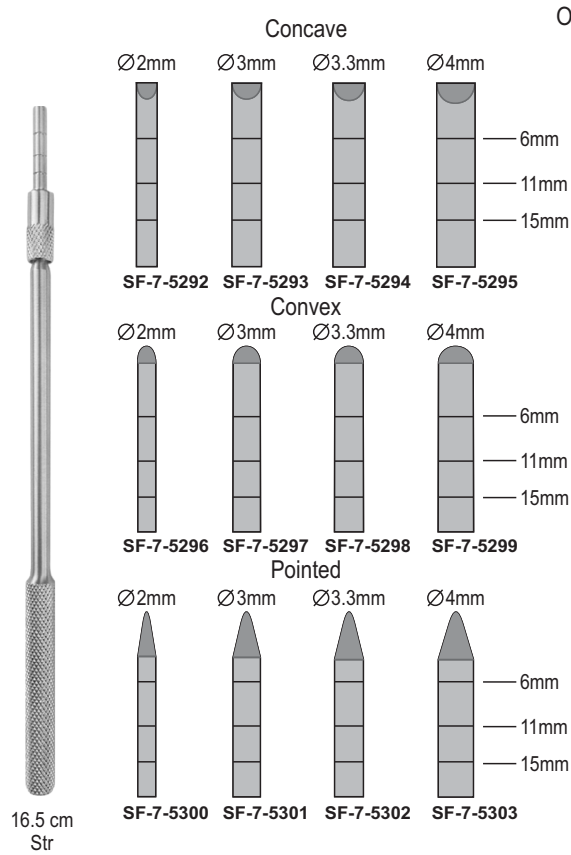

## PDL Elevators



**SF-7-5345** Distal, 2.5 mm Micro Edge

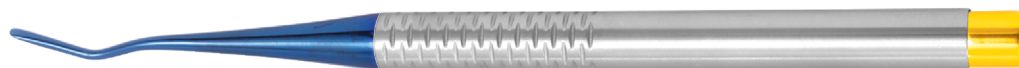

**SF-7-5346** Mesial, 2.5 mm Micro Edge



**SF-7-5347** Distal, 4 mm Micro Edge



**SF-7-5348** Mesial 4 mm Micro Edge

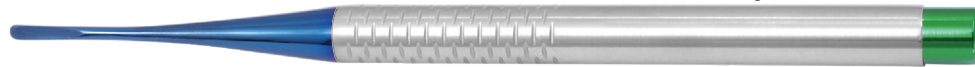

**SF-7-5349** 2.5 mm Micro Edge, Straight



**SF-7-5350** 2.5 mm Micro Edge, Curved



**SF-7-5351** 3.4 mm Straight

**SF-7-5352** Set Of 7 Pieces



**SF-7-5353** Distal, 2.5 mm Micro Edge

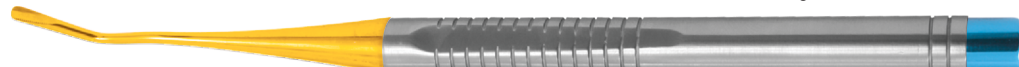

**SF-7-5354** Mesial, 2.5 mm Micro Edge



**SF-7-5355** Distal, 4 mm Micro Edge

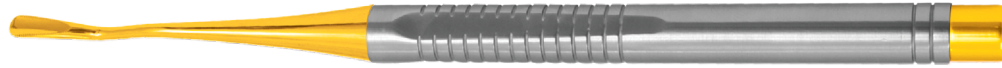

**SF-7-5356** Mesial 4 mm Micro Edge



**SF-7-5357** 2.5 mm Micro Edge, Straight



**SF-7-5358** 2.5 mm Micro Edge, Curved



**SF-7-5359** 3.4 mm Straight

**SF-7-5360** Set Of 7 Pieces



Instruments Tray

Trephine Drills



**SF-7-5361**  
Interior 2 mm  
Exterior 3 mm



**SF-7-5362**  
Interior 3 mm  
Exterior 4 mm



**SF-7-5363**  
Interior 4 mm  
Exterior 5 mm



**SF-7-5364**  
Interior 5 mm  
Exterior 6 mm



**SF-7-5365**  
Interior 6 mm  
Exterior 7 mm



**SF-7-5366**  
Interior 7 mm  
Exterior 8 mm



**SF-7-5367**  
Interior 8 mm  
Exterior 9 mm



**SF-7-5368**  
Interior 9 mm  
Exterior 10 mm



**SF-7-5369**  
Trephine Drills Stand  
Complete with drills



**SF-7-5370**  
Trephine Drills Stand  
Complete with drills

Tissue Punches



Keyes

- SF-7-5371**  
2 mm
- SF-7-5372**  
3 mm
- SF-7-5373**  
4 mm
- SF-7-5374**  
5 mm

- SF-7-5375**  
6 mm
- SF-7-5376**  
7 mm
- SF-7-5377**  
8 mm



Keyes

- SF-7-5378**  
3 mm
- SF-7-5379**  
4 mm
- SF-7-5380**  
5 mm
- SF-7-5381**  
6 mm



**SF-7-5382**  
Bone Collector Chisel Straight



**SF-7-5383**  
Blade for Straight bone collector chisel



**SF-7-5384**  
Bone Collector Chisel Curved



**SF-7-5385**  
Blade for Curved bone collector chisel



**SF-7-5386**  
Ratchet Screw driver handle  
Hexagonal head



**SF-7-5387**  
Bone Morselizer with Titanium Grinding



**SF-7-5388**  
Bone Mixing Basin  
Dia 35 mm



**SF-7-5389**  
Manual Easy Bone Mill



**SF-7-5390**  
Bone Craker Titanium

Page  
152–155

- Impression Trays

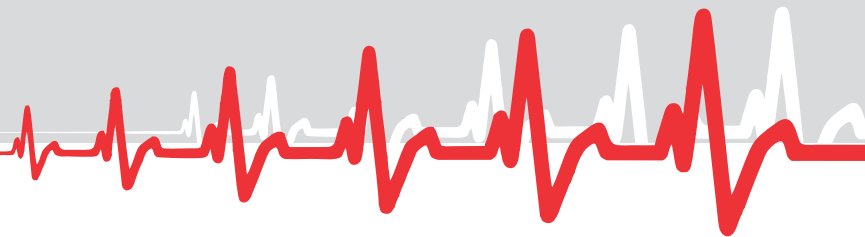

All Impression Trays Upper & Lower Type  
are available in S, M, L & XL Sizes



**SF-7-5391**  
"HYDRO-LOCK"  
stainless steel  
water-cooled  
impression trays  
with retention rim.



**SF-7-5392**  
"HYDRO-LOCK"  
stainless steel  
water-cooled impression  
trays with retention rim.



**SF-7-5393**  
"NEW SUPER"  
stainless steel  
impression trays  
with retention rim.



**SF-7-5394**  
"NEW SUPER" stainless  
steel impression trays  
with retention rim.



**SF-7-5395**  
"ANATOMIC" solid  
regular stainless  
steel impression  
trays without  
retention rim.



**SF-7-5396**  
"ANATOMIC" solid regular  
stainless steel impression  
trays without retention rim.



**SF-7-5397**  
Perforated-total denture  
stainless steel  
impression trays with rim.



**SF-7-5398**  
Perforated-total denture  
stainless steel  
impression trays with rim.

All Impression Trays Upper & Lower Type  
are available in S, M, L & XL Sizes



**SF-7-5399**  
"PERMA-LOCK" solid regular stainless steel impression trays with retention rim.



**SF-7-5400**  
"PERMA-LOCK" solid regular stainless steel impression trays with retention rim.



**SF-7-5401**



**SF-7-5402**



**SF-7-5403**



**SF-7-5404**



**SF-7-5405**



**SF-7-5406**



**SF-7-5407**  
Set of six

## PACKINGS



**SF-7-5408**  
Set of Eight



**SF-7-5409**  
Solid stainless steel anterior depressed impression trays with retention rim.



**SF-7-5410**



**SF-7-5411**



**SF-7-5412**



**SF-7-5413**



**SF-7-5414**



**SF-7-5415**



**SF-7-5416**  
Solid stainless steel anterior depressed impression trays with retention rim.



All Impression Trays Upper & Lower Type  
are available in S, M, L & XL Sizes



**SF-7-5417**  
Fig. 0 per bambini - for children

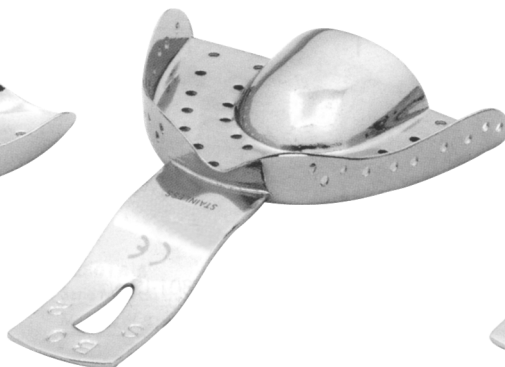

**SF-7-5418**  
For narrow toothed upper jaws



**SF-7-5419**  
Fig. 0 per bambini - for children



**SF-7-5420**  
For partially toothed upper jaws



**SF-7-5421**  
For partially toothed lower jaws



**SF-7-5422**  
For edentulous upper jaws



**SF-7-5423**  
For edentulous lower jaws

# Stainless Steel Impression Trays

[www.surgiforce.com](http://www.surgiforce.com)

All Impression Trays Upper & Lower Type are available in S, M, L & XL Sizes



**SF-7-5424**  
Solid total denture stainless steel impression tray with rim.



**SF-7-5425**  
Solid total denture stainless steel impression tray with rim.



**SF-7-5426**  
"PERMA-LOCK" perforated regular stainless steel impression trays with retention rim.



**SF-7-5427**  
"PERMA-LOCK" perforated regular stainless steel impression trays with retention rim.



**SF-7-5428**  
Perforated stainless steel anterior depressed impression trays with retention rim.



**SF-7-5429**



**SF-7-5430**



**SF-7-5431**



**SF-7-5432**



**SF-7-5433**



**SF-7-5434**



**SF-7-5435**  
Perforated stainless steel anterior depressed impression trays with retention rim.



**SF-7-5436**  
Perforated stainless steel impression trays without retention rim for complete denture.



**SF-7-5437**  
Perforated stainless steel impression trays without retention rim for complete denture.

Page  
156-157

- Arriculators

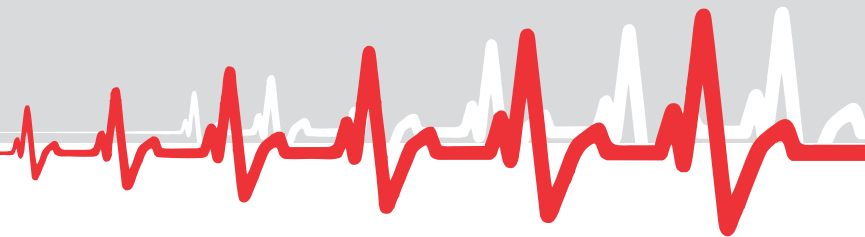

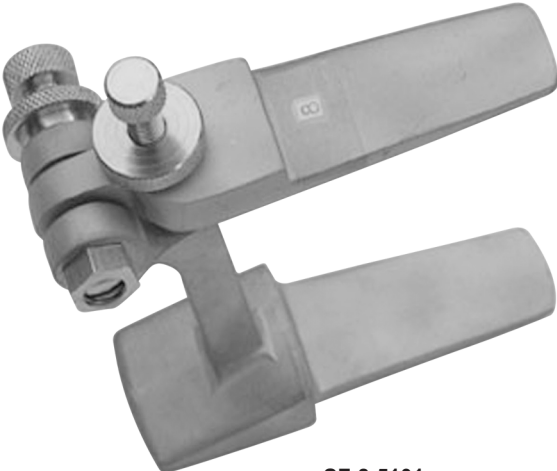

SF-8-5101



SF-8-5102



SF-8-5103



SF-8-5104

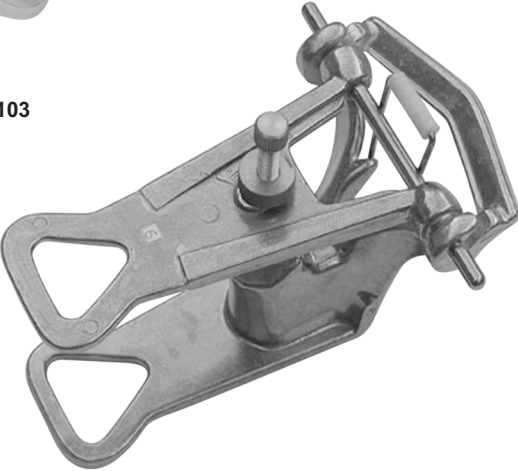

SF-8-5105



SF-8-5106

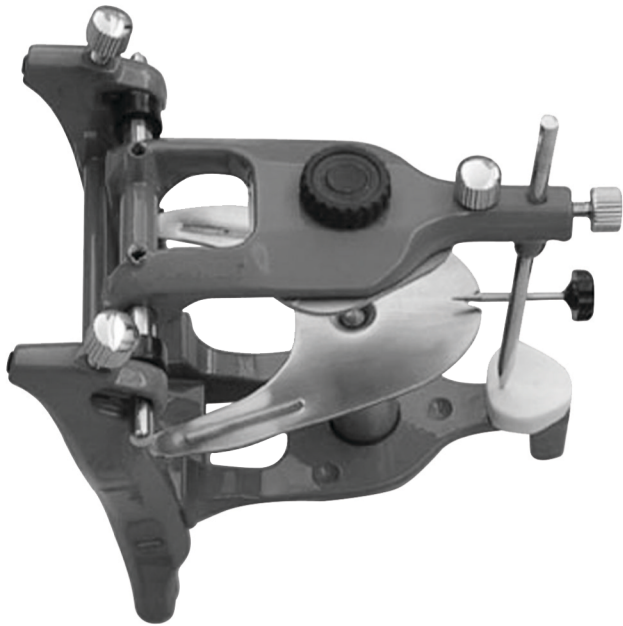

SF-8-5107



SF-8-5108



SF-8-5109



SF-8-5110

Page  
158-160

- Dental Surgical Hollowares

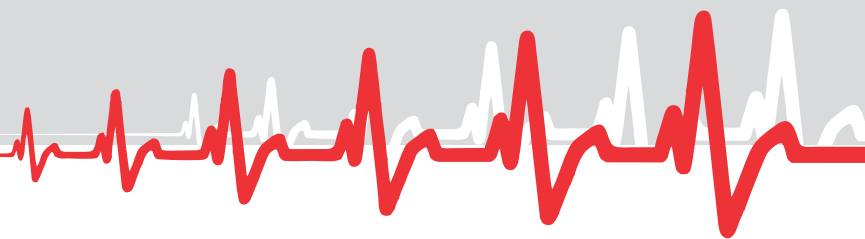

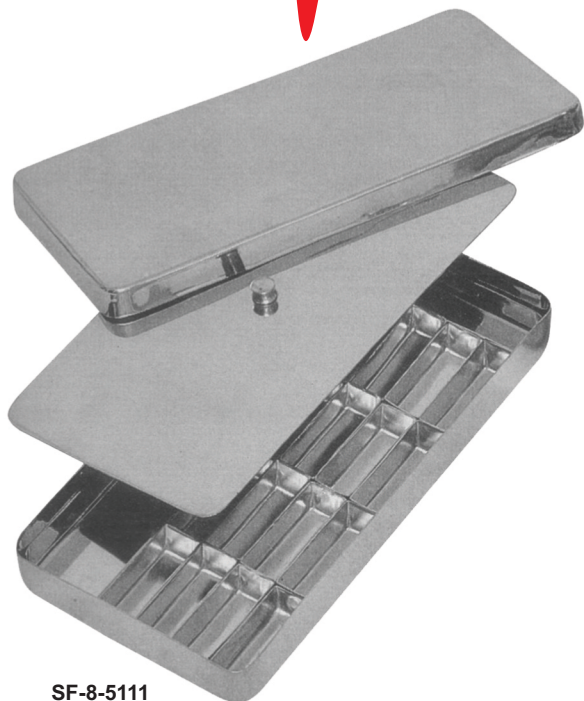

**SF-8-5111**  
**ENDODONTIC BOX**



**SF-8-5112**  
**STERILIZING BOX**  
Available in dif. sizes  
17x17x3 cm  
20x10x4 cm  
25x12x6 cm  
30x14x6 cm



**SF-8-5113**  
**ENDO TRAY BOX**

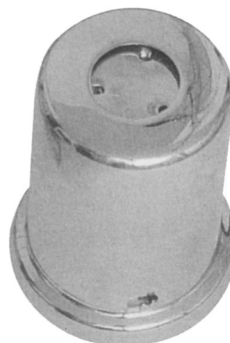

**SF-8-5114**  
**COTTON DISPENSER**

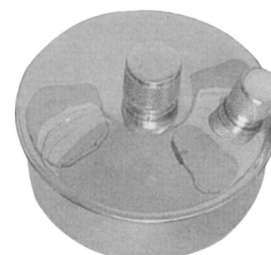

**SF-8-5115**  
**ALCOHOL LAMP**

**Sterilizing Drums**



**SF-8-5116**



**SF-8-5117**



**SF-8-5118**

**Sterilizing Boxes**



SF-8-5119



SF-8-5120



SF-8-5121

**Sterilizing Boxes**



SF-8-5122



SF-8-5123



SF-8-5124



SF-8-5125



SF-8-5126



SF-8-5127

**FORCEP AND THERMOMETER JARS**

**COTTON DISPENSER**



SF-8-5128  
IRRIGATOR(Douch can)



SF-8-5129  
MEASURING JUG



SF-8-5130  
KIDNEY TRAY





SF-8-5131  
**FORCEP JAR**

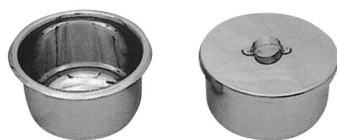

SF-8-5132  
**GALLIPOT WITH & WITHOUT LID**



SF-8-5133  
**SPITTEN MUG**



SF-8-5134  
**SPIRIT LAMP**

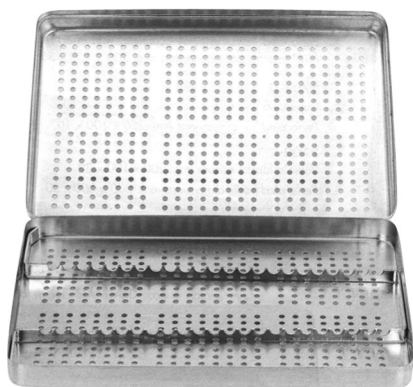

SF-8-5135  
**Perforated Tray**



SF-8-5136  
**Perforated Base**

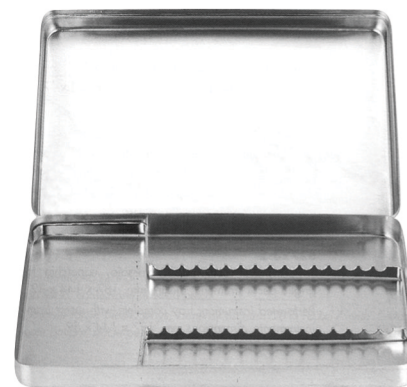

SF-8-5137  
**Solid Base**



SF-8-5138  
**Instruments Tray**



SF-8-5139  
**Instruments Tray**



SF-8-5140  
**Instruments Tray  
(Perforated)**



SF-8-5141  
**Instruments Tray Shallow  
(Mayo)**



SF-8-5142  
**Scalers Tray**



SF-8-5143  
**Cathetar Tray**

# Alphabetical Index

[www.surgiforce.com](http://www.surgiforce.com)

- A**  
Adams 125, 133  
Aderer 133  
Adson 96  
Ainsworth 110  
Albee 77  
Albrecht 109  
Alcohol Lamp 142  
Alginate 93-94  
Allen 109  
Amalgam Carriers 117  
Amalgam Guns 117  
Amalgam Well 117  
Andresen 134  
Angle 133  
Antkoviak 78  
Apical 36, 44  
Arruga 97  
Articulators 140  
Ash 53, 88  
Aspirating Syringes 102
- B**  
Band Adaptor 102  
Barry 47, 50  
Baumgarthner 96  
Beale 76  
Beebee 116  
Bein 33, 40  
Bennet 53, 123  
Beyer 121  
Bicuspid 114  
Birdbeak Pliers 132  
Blumenthal 120, 121  
Bohler 120  
Bohm 118  
Boley 77  
Bone Chisels 68  
Boynton 97  
Breech Loading Syringe 102  
Brewer 110  
Buck 61-63, 65  
Buckley 67, 124  
Burnishers 58
- C**  
Caroll 77  
Castroviejo 77, 98, 100  
Cathetar Tray 144  
Cement Spatulas 91, 92  
Chompret 44  
Ck1 108  
CK2 108
- Cleveland 122  
College 105, 107  
Columbia 64, 66, 74  
Columbia 79  
Cone-Socket 90  
Cork Screw Tip 104  
Cotton Dispenser 142, 143  
Coupland 37  
Crane-kaplan 74  
Crile-Wood 96  
Crown Removers 115-116  
Cryer 35, 37, 48  
Curette 64, 66
- D**  
De La Rosa 129  
Dental Probes 57  
Dental Syringes 103-104  
Derf 95  
Didner 113
- E**  
Eliselberg-Mathieu 97  
Eliott 53  
Endo Finger Ruler 102  
Endo Tray Box 142  
Endodontic Box 142  
Ermer 78  
Excavators 87-88  
Explorers 81  
Extracting Forceps 01-31
- F**  
Fahnenstock 79  
Filling Instruments 52-56  
Fischer 134  
Flagg 107  
Flohr 38  
Forcepps Jar 143, 144  
Fox 58  
Fraizer 100  
Freer 123  
Friedman 119-120  
Furrer 119
- G**  
Gallipot 144  
Gardner 67, 122  
GF1 108  
GF2 108  
Gillies 96  
Goldman Fox 60, 63, 65, 73, 120
- Goslee 134  
Gouges 68  
Gracey Curettes 69  
Gracey Mesial Distal 69  
Gracey 56-69-72  
Gritman 76-78-80
- H**  
Halstead-Mosquito 118  
Hegar-Baumgartner 95-96  
Heidbrink 45-48-50  
Heidemann 55  
Hemingway 75  
Henahan 123  
How 133  
Hylin 40, 76
- I**  
Impression Trays 136-139  
Intra-Ligamental Syringes 104  
Irrigator 143  
Ivory 110, 113  
Iwanson 77
- J**  
Jaquette 74  
Johnson 133
- K**  
Kelly 118  
Kerrison 120  
Kidney Tray 143  
Kilian 124  
Kilian-Claus 124  
Klein 07  
Kleinert-Kutz 121  
Kopp 39, 49, 108
- L**  
Landgraf 107  
Langenbeck 134  
Le Cron 76  
Lecluse 43  
Lessmann 79  
Lichtenberg 97  
Listion-mini 122  
London Hospital 41  
London-College 107, 109  
Lucas 75  
Luer 120  
Luks 84

<b>M</b>					
Machtou	83	Rhodium	89	Wakefield	
Mallets	68	Roach	76	Waldron	67
Mathieu	99, 100	Root Elevators	32--51	Waldsachs	133
Matrix Bands	113, 114	Root Splinter	31	Warwick-James	130, 133
Matrix Retainers	113	Root-Canal Excavators	86	Water Syringe	41
Mayo-Hegar	95	Root-Canal Explorers	86	Weingart	101
Mc Call	73	Root-Canal Plungers	84-85	White	129, 133
Mc Kellops	133	Rubber Dam Clamps	111-112	Williams	52, 60, 83
Mead	43, 58, 119	Rubber Dam Frame	110	Williger	123
Measuring Jug	143	Ruskin-Mini	121	Winter	46, 50
Measuring Plate	84			Woodson	54, 55
Medicon	78	<b>S</b>			
Meriam	106, 109	Scalers	58		
Merrit A	60	Schell	119	<b>Y</b>	
Mershon	110, 116	Schilder	85	Young	133
Micro-Barraquer	99-100	Schluger	61, 62	Younger-Good	73
Micro-Mosquito	118	Schwarz	134		
Miller	118, 124	Seldin	34, 48, 123	<b>Z</b>	
Mini-Ryder	95	Spirit Lamp	144	Zahle	76
Molar	114	Spitten Mug	144	Zaufal-Jansen	121
Morell	116	Spreader	82-83	Zerfing-Chisel	64, 66
Mouth Mirror Handles	89, 90	Sterilizing Boxes	142, 143	Zuricher	77
Mouth Mirrors	89, 90	Sterilizing Drums	142		
MSY	76, 134	Sugarman	61, 162		
<b>N</b>					
Nabers	83	<b>T</b>			
Nance	128, 133	Taylor	74		
Niro	122	Toennis	97		
<b>O</b>					
Obwegeser	124	Tofflemire	114		
Ochsenbein	61, 62, 67	Tofflemire-Junior	113		
Olsen-Heger	96	Tofflemire-Senior	113		
Oms	83	Tofflemire-Universal	113		
Ott	41	Towner Jaquette	74		
<b>P</b>					
P	76	Towner	74		
P.K. Thomas	68	Trays	144		
Partsch	134	Treyman	116		
Pocket Probes	58-60	Tweed	130		
Plaster Knives	80	<b>U</b>			
Plaster Spatulas	93-94	Univarsal "HM"	116		
Position Gauge	102	Univarsal	128, 133		
Pott	42	University of Michigan	60		
<b>R</b>					
Rein	81	USA Model	133		
Relax	05	<b>V</b>			
Reynolds	129	Vehe	76		
Rhodes	61, 62	Vernier	77		
		Vertical Condenser	83		



# Surgiforce Instruments



Opposite Surgical Association,  
Malkay Kalan, Marala Road,  
Sialkot-51050 Pakistan.



+92 523 559131



info@surgiforce.com  
sales@surgiforce.com



www.surgiforce.com



## Our Certifications:

ISO 9001

CE Certified

EN 13485:2012

ISO 7153-1

ISO 7151

ISO 17664:2004

ISO 13402

ISO 15223

