

# Surgiforce Instruments



Stainless Steel  
**HOLLOWWARE**  
Catalogue

[www.surgiforce.com](http://www.surgiforce.com)

## Page 1-13

- Kidney Trays
- Bowls
- Instruments Trays
- Sterilization Drums and Baskets

# Company Profile

We at **SURGIFORCE INSTRUMENTS** welcome you to the world of reliable quality in the products where it matters the most, to the world of precision, where lack of it could be a matter of life and death.

**SURGIFORCE INSTRUMENTS** is an industry leader in manufacturing and providing worldwide solutions for SURGICAL / DENTAL / DIAGNOSTIC & HOLLOW WARE instruments.

Our Professionals continually strive to satisfy your technical and clinical needs of surgical instruments. We maintain a team work environment throughout the company by placing experienced members on critical manufacturing processes in instrument craftsmanship with state-of-the-art precision manufacturing equipments and the latest technologies to achieve the highest possible results.

Our instruments range from precision micro handheld surgical instruments(including forceps, clamps, scissors, needle holders, cutting and clamping devices) used in general surgery, ophthalmic, neurosurgical, ENT and cardiovascular specialties to macro instruments used in spinal, orthopedic and other surgical areas.

**SURGIFORCE INSTRUMENTS** holds worldwide recognized certifications such as:

ISO 9001

CE Certified

EN 13485:2012

ISO 7153-1

ISO 7151

ISO 17664:2004

ISO 13402

ISO 15223



Which ensures our clientage that they are in best hands when it comes to quality of the instruments as well as their compliance with the international standards.

Our Quality policy ensures that every instrument is manufactured to its highest quality by maintaining quality checks at every stage, as it is our belief that our success depends on establishing enduring relationships with our customers and consistently producing high quality products that meet their demanding standards and timetables.

---

## Production View





**SF-1001 - SF-1015**  
Schimmelbusch

	Ø x H sizes in mm
<b>SF-1001</b>	80 x 80
<b>SF-1002</b>	105 x 120
<b>SF-1003</b>	140 x 140
<b>SF-1004</b>	160 x 120
<b>SF-1005</b>	160 x 150
<b>SF-1006</b>	190 x 150
<b>SF-1007</b>	190 x 190
<b>SF-1008</b>	240 x 160
<b>SF-1009</b>	240 x 240
<b>SF-1010</b>	290 x 160
<b>SF-1011</b>	290 x 240
<b>SF-1012</b>	340 x 160
<b>SF-1013</b>	340 x 340
<b>SF-1014</b>	390 x 190
<b>SF-1015</b>	390 x 290

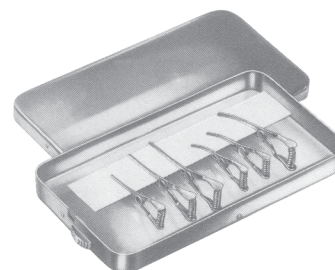

**SF-1016**  
Box  
120 x 65 x 13mm  
(without Bulldog clamps,  
without silicone tape)



**SF-1017**  
Box with support  
120 x 65 x 13 mm  
(ohne Bulldogklemmen)



**SF-1018**  
Box with support for  
needle electrodes,  
without instruments

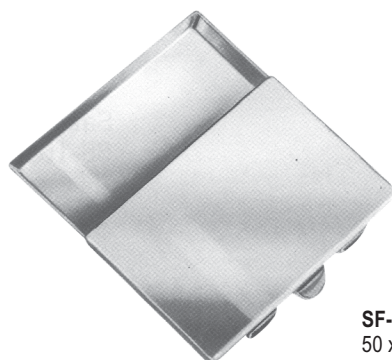

**SF-1019 - SF-1020**  
50 x 25 x 4,5 mm  
**SF-1019**  
65 x 42 x 8 mm  
**SF-1020**  
75 x 25 x 4,5 mm



**SF-1021**  
Ø65mm x 15mm



**SF-1022 - SF-1030**

	Ø x H
<b>SF-1022</b>	30 x 90 mm
<b>SF-1023</b>	50 x 100 mm
<b>SF-1024</b>	50 x 130 mm
<b>SF-1025</b>	50 x 175 mm
<b>SF-1026</b>	75 x 100 mm
<b>SF-1027</b>	75 x 130 mm
<b>SF-1028</b>	75 x 175 mm
<b>SF-1029</b>	100 x 175 mm
<b>SF-1030</b>	100 x 200 mm



**13-131 - SF-1038**

<b>SF-1031</b>	165 x 85 x 35 mm
<b>SF-1032</b>	200 x 100 x 35 mm
<b>SF-1033</b>	200 x 100 x 50 mm
<b>SF-1034</b>	230 x 130 x 50 mm
<b>SF-1035</b>	260 x 150 x 50 mm
<b>SF-1036</b>	270 x 235 x 50 mm
<b>SF-1037</b>	300 x 200 x 50 mm
<b>SF-1038</b>	325 x 275 x 50 mm



**SF-1039**

205 x 105 x 35 mm



**SF-1040 - SF-1041**

- |                |   |
|----------------|---|
| <b>SF-1040</b> | Martin Sterilizing Forceps<br>consisting of:<br>1 Sterilizing Forceps, curved, 25 cm,<br>without ratchet, with lid for jar<br>1 jar with bottom plate (anti-tilt) |
| <b>SF-1041</b> | ditto, with 32 cm long Sterilizing Forceps  |



**SF-1043 - SF-1048**     $\varnothing \times H$

<b>SF-1042</b>	75 x 60 mm
<b>SF-1043</b>	75 x 75 mm
<b>SF-1044</b>	100 x 60 mm
<b>SF-1045</b>	100 x 100 mm
<b>SF-1046</b>	125 x 80 mm
<b>SF-1047</b>	125 x 125 mm
<b>SF-1048</b>	150 x 150 mm

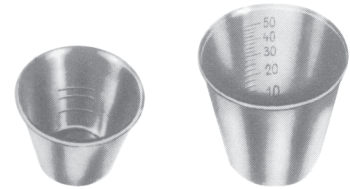

**SF-1049**  
25 cc

**SF-1050**  
50 cc



**SF-1051**  
 $\varnothing 90 \times 90$  mm  
Metal Cup



**SF-1052**  
 $\varnothing 75 \times 80$  mm  
Sputum Cup



**SF-1053**  
20 cc  
Medicine Spoon



**SF-1054**  
 $\varnothing 75 \times 12$  mm  
Tablet Tray



**SF-1055 - SF-1062**

Ø x H

<b>SF-1055</b>	40 x 19	mm	0.05L
<b>SF-1056</b>	61 x 30	mm	0.07L
<b>SF-1057</b>	80 x 40	mm	0.14L
<b>SF-1058</b>	116 x 50	mm	0.35L
<b>SF-1059</b>	128 x 55	mm	0.45L
<b>SF-1060</b>	147 x 65	mm	0.70L
<b>SF-1061</b>	167 x 75	mm	1.10L
<b>SF-1062</b>	187 x 85	mm	1.60L

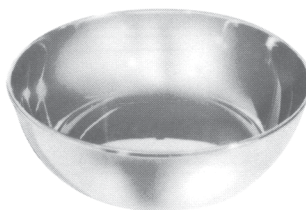

**SF-1063 - SF-1067**

<b>SF-1063</b>	116 x 35	mm	0.30L
<b>SF-1064</b>	128 x 38	mm	0.40L
<b>SF-1065</b>	147 x 40	mm	0.50L
<b>SF-1066</b>	157 x 45	mm	0.75L
<b>SF-1067</b>	187 x 45	mm	1.00L



**SF-1068**

Ø110 x 28 mm 0.15L



**SF-1069**

100 cc 0.1L



**SF-1070 - SF-1073**

<b>SF-1070</b>	0,25L
<b>SF-1071</b>	0,50L
<b>SF-1072</b>	1,00L
<b>SF-1073</b>	2,00L



**SF-1074**

235 x 190 x 40 mm



**SF-1075**

Ø220 x 70 mm





**SF-1076**  
Ø50 x 100 mm  
Powder Pot



**SF-1077**  
50 x 75 mm  
Methot With Lid



**SF-1078**  
Ø50 x 75 mm  
Methot Without Lid



**SF-1079**



**SF-1080**



**SF-1081**

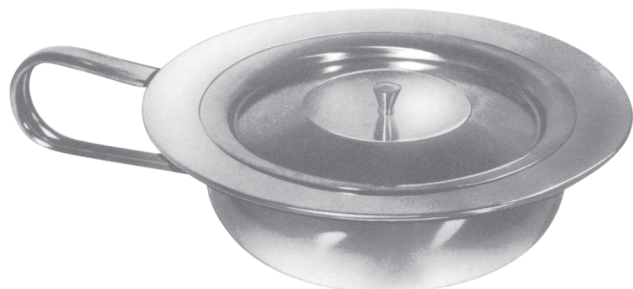

**SF-1082 - SF-1083**  
**SF-1082** Ø235 mm  
**SF-1083** Ø310 mm



**SF-1084**  
Sauerbruch  
210 x 125 x 17 mm



**SF-1085**  
Sauerbruch  
210 x 125 x 17 mm



**SF-1086**  
150 x 95 x 13 mm



**SF-1087**  
150 x 95 x 13 mm



**SF-1088**  
150 x 95 x 13 mm



**SF-1089**  
150 x 95 x 13 mm



**SF-1090**  
150 x 95 x 13 mm



**SF-1091**  
150 x 95 x 13 mm

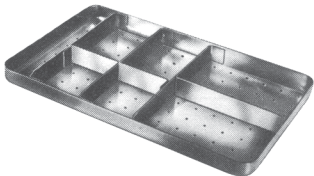

**SF-1092**  
150 x 95 x 11 mm



**SF-1093**  
Deponette  
245 x 135 x 35mm



**SF-1094**  
Deponette  
245 x 135 x 50mm



**SF-1095**  
Deponette  
245 x 135 x 60mm

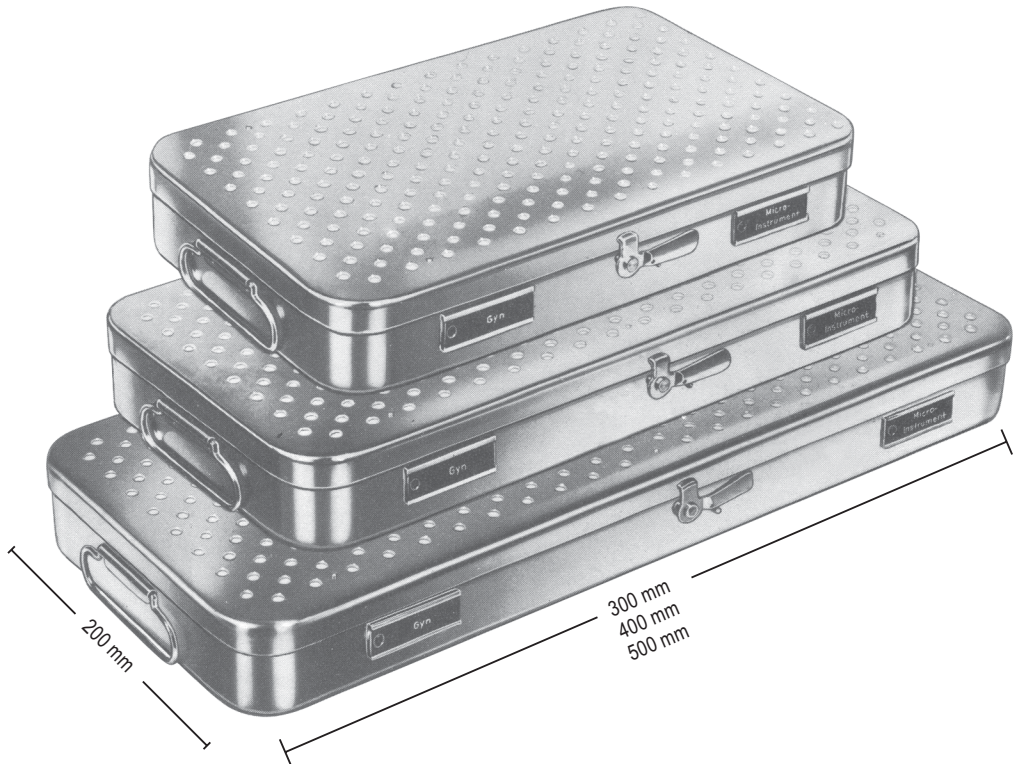

**SF-1096 - SF-1106**

<b>SF-1096</b>	230 x 130 x 50 mm
<b>SF-1097</b>	260 x 150 x 50 mm
<b>SF-1098</b>	275 x 235 x 50 mm
<b>SF-1099</b>	300 x 200 x 50 mm
<b>SF-1100</b>	325 x 275 x 50 mm
<b>SF-1101</b>	420 x 175 x 50 mm
<b>SF-1102</b>	230 x 130 x 75 mm
<b>SF-1103</b>	260 x 150 x 75 mm
<b>SF-1104</b>	300 x 200 x 75 mm
<b>SF-1105</b>	325 x 275 x 75 mm
<b>SF-1106</b>	420 x 175 x 75 mm

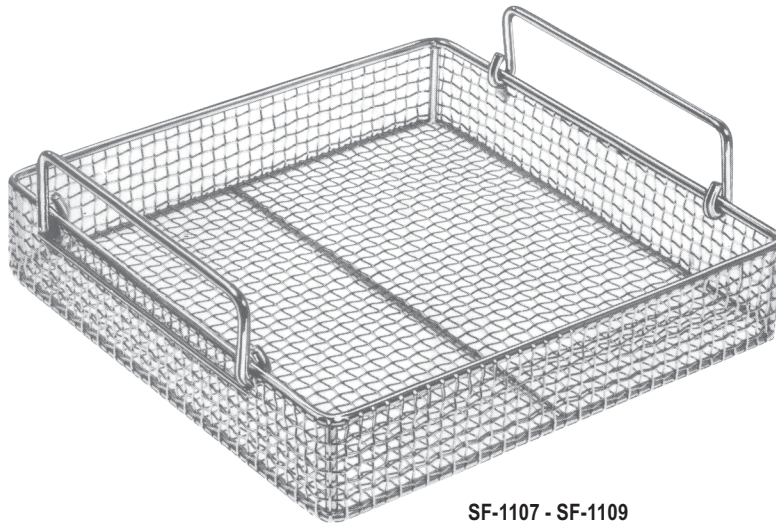

SF-1107 - SF-1109

<b>SF-1107</b>	480 x 250 x 50	mm
<b>SF-1108</b>	520 x 250 x 75	mm
<b>SF-1109</b>	520 x 250 x 100	mm



SF-1110 - SF-1115

<b>SF-1110</b>	240 x 240 x 50	mm
<b>SF-1111</b>	240 x 240 x 80	mm
<b>SF-1112</b>	240 x 240 x 100	mm
<b>SF-1113</b>	480 x 260 x 50	mm
<b>SF-1114</b>	520 x 260 x 80	mm
<b>SF-1115</b>	520 x 260 x 100	mm

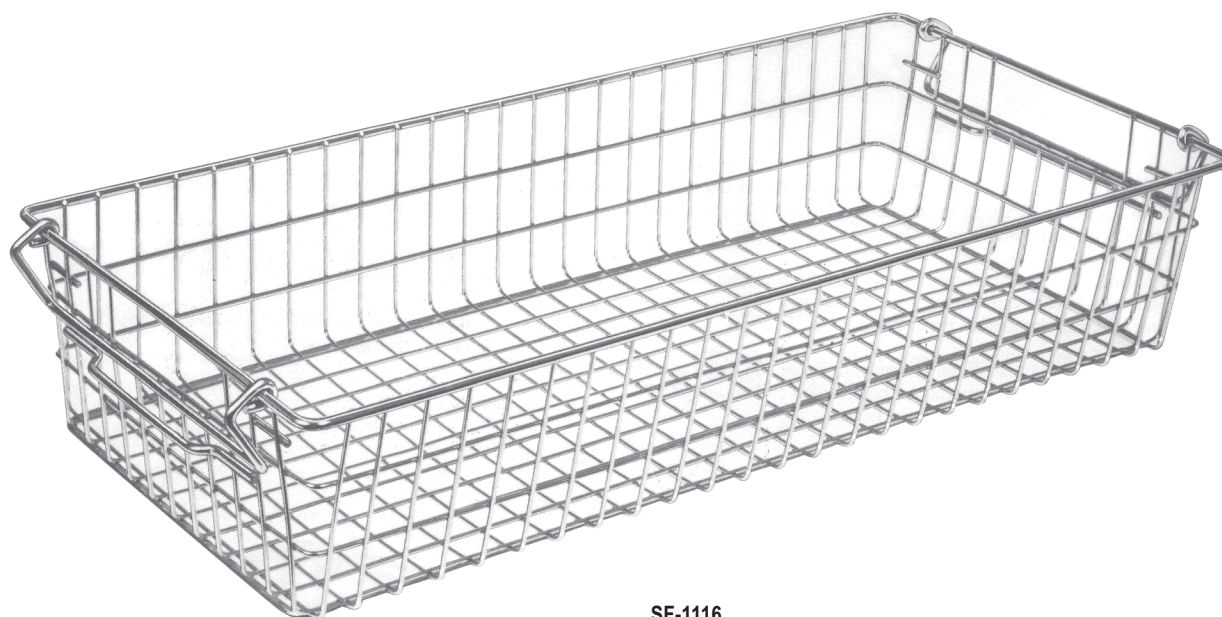

**SF-1116**  
(60 x 30 x 15 cm)  
Nominal dimensions

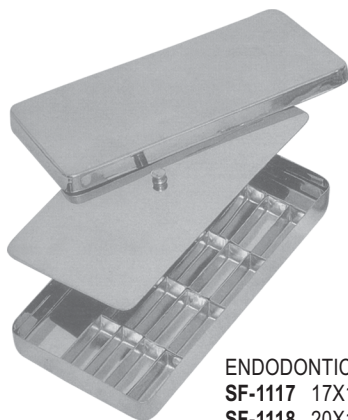

**ENDODONTIC BOX**  
**SF-1117** 17X17X3 cm  
**SF-1118** 20X10X4 cm  
**SF-1119** 25X12X6 cm  
**SF-1120** 30X14X6 cm



**STERILIZING BOX**  
**SF-1121** 17X17X3 cm  
**SF-1122** 20X10X4 cm  
**SF-1123** 25X12X6 cm  
**SF-1124** 30X14X6 cm



**ENDO TRAY BOX**  
**SF-1125**



**INSTRUMENT BOX WITH LOCK**  
**SF-1126** 8" X 4" X 1/2"  
**SF-1127** 8" X 6" X 2"  
**SF-1128** 10" X 6" X 2"  
**SF-1129** 12" X 6" X 2"  
**SF-1130** 12" X 8" X 2"



**INSTRUMENT BOX**  
**SF-1131** 8" X 4" X 1"  
**SF-1132** 8" X 6" X 2"  
**SF-1133** 10" X 6" X 2"  
**SF-1134** 12" X 6" X 2"  
**SF-1135** 12" X 8" X 2"



**PERFORATED STERILIZING BOX**  
**SF-1136** 8" X 4" X 1"  
**SF-1137** 8" X 6" X 2"  
**SF-1138** 10" X 6" X 2"  
**SF-1139** 12" X 6" X 2"  
**SF-1140** 12" X 8" X 2"



**STERILIZING DRUM**  
**SF-1141**  
 6"x5"



**STERILIZING DRUM**  
**SF-1142**  
 6"x6"



**STERILIZING DRUM**  
**SF-1143**  
 8"x8"



**IRRIGATOR (DOUCH CAN)**  
**SF-1144** 1000 ml  
**SF-1145** 1500 ml  
**SF-1146** 2000 ml



**GRADUATED JUG**  
**SF-1147** 500 ml  
**SF-1148** 1000 ml  
**SF-1149** 2000 ml



**KIDNEY TRAY**  
**SF-1150**  
 Emesis Basins (Deep)  
 5" 6" 8" 10" 11" 12" 14"



OUNCES  
**SF-1151**  
10, 20, 40, 60, 80



OUNCE  
**SF-1152**  
40



SPITTEN MUG  
**SF-1153**



SPIRIT LAMP  
**SF-1154**

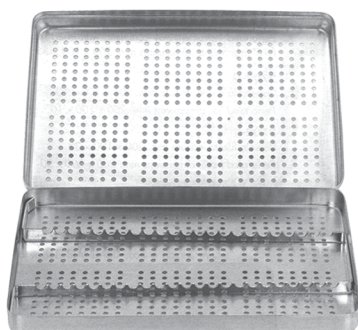

PERFORATED TRAY  
**SF-1155** 288 X 187 X 40 mm  
**SF-1156** 180 X 140 X 40 mm

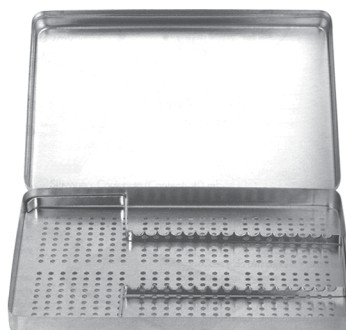

PERFORATED BASE  
**SF-1157** 288 X 187 X 40 mm  
**SF-1158** 180 X 140 X 40 mm



SOLID BASE  
**SF-1159** 288 X 187 X 40 mm  
**SF-1160** 180 X 140 X 40 mm



INSTRUMENTS TRAY  
**SF-1161**  
8" X 4" X 1"



INSTRUMENTS TRAY  
WITH COVER  
**SF-1162** 8" X 6" X 2"  
**SF-1163** 10" X 8" X 2"  
**SF-1164** 12" X 7" X 2"



INSTRUMENTS TRAY  
PERFORATED  
**SF-1165**  
12" X 6" X 1"



INSTRUMENTS TRAY  
SHALLOW MAYO  
**SF-1166** 8" X 6" X 1½"  
**SF-1167** 9" X 6" X 1½"  
**SF-1168** 12" X 8" X 2"

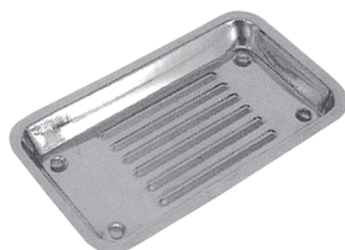

SCALER TRAY  
**SF-1169** 200 X 100 X 15 mm  
**SF-1170** 200 X 150 X 15 mm



CATHETER TRAY  
**SF-1171** 222 X 82 X 40 mm  
**SF-1172** 225 X 125 X 50 mm  
**SF-1173** 325 X 90 X 50 mm





# Surgiforce Instruments



Opposite Surgical Association,  
Malkay Kalan, Marala Road,  
Sialkot-51050 Pakistan.



+92 523 559131



info@surgiforce.com  
sales@surgiforce.com



www.surgiforce.com



## Our Certifications:

ISO 9001

CE Certified

EN 13485:2012

ISO 7153-1

ISO 7151

ISO 17664:2004

ISO 13402

ISO 15223

