

Page  
78-102

- Self-Retaining Retractors
- Abdominal Retractors

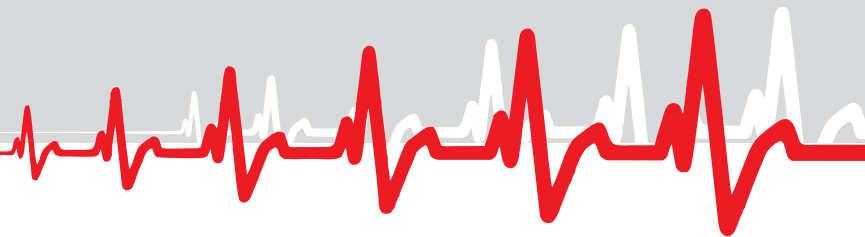

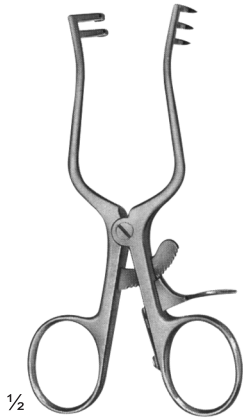

**SF-04-101**  
WEITLANER  
Sharp  
110 mm

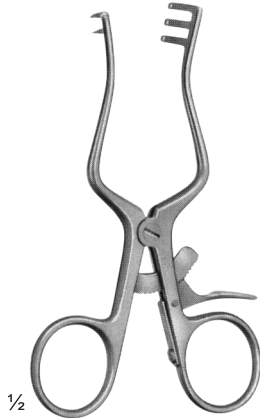

**SF-04-102**  
WEITLANER  
Semi-Sharp  
110 mm



**SF-04-103**  
WEITLANER  
Blunt  
110 mm

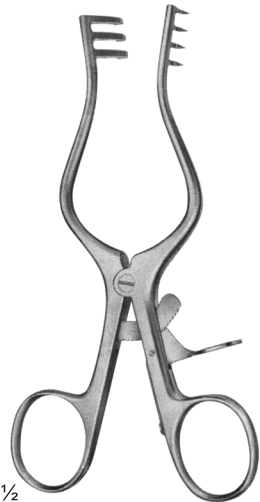

**SF-04-104**  
WEITLANER  
Sharp  
130 mm

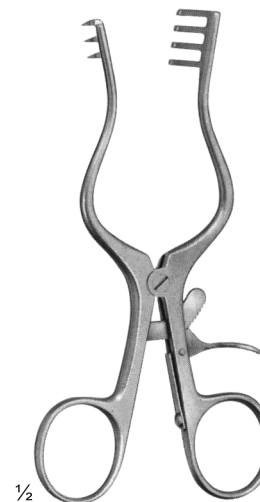

**SF-04-105**  
WEITLANER  
Semi-Sharp  
130 mm

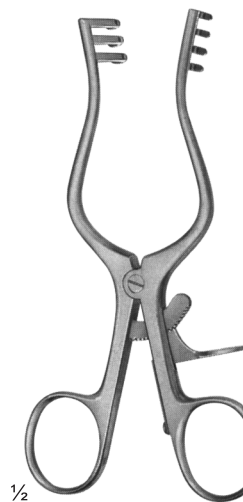

**SF-04-106**  
WEITLANER  
Blunt  
130 mm

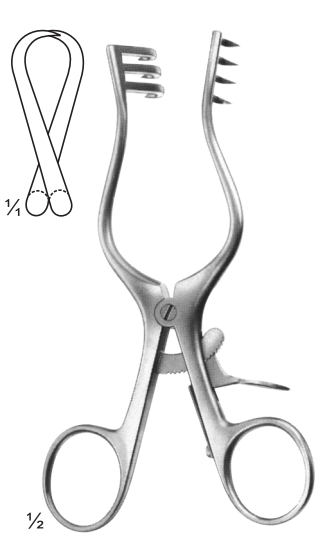

**SF-04-107**  
WEITLANER  
Sharp  
130 mm

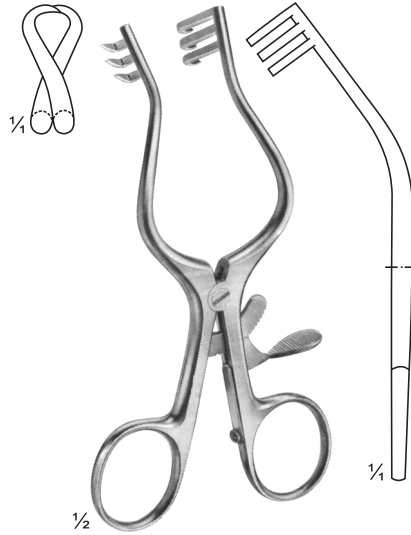

**SF-04-108**  
WULLSTEIN  
Sharp  
130 mm

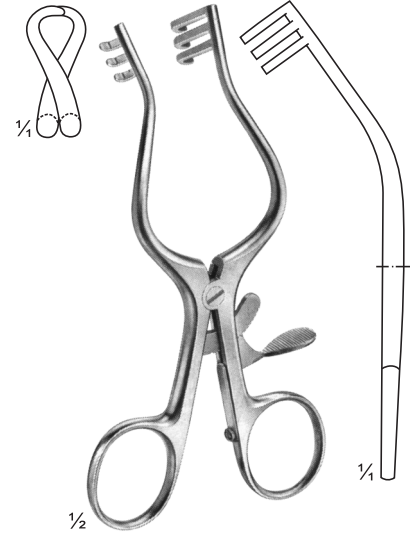

**SF-04-109**  
WULLSTEIN  
Blunt  
130 mm

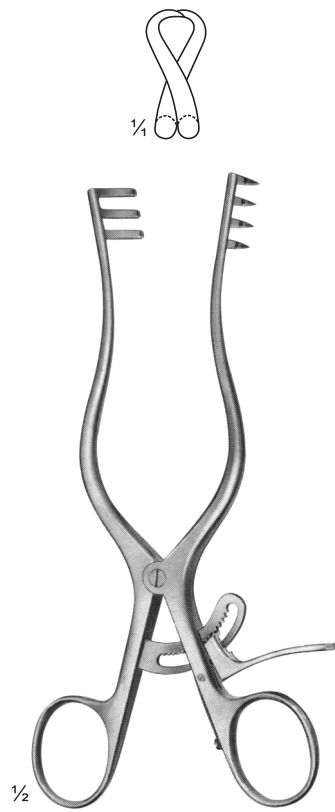

**SF-04-110**  
WEITLANER  
Sharp  
165 mm



**SF-04-111**  
PLESTER  
Blunt  
110 mm

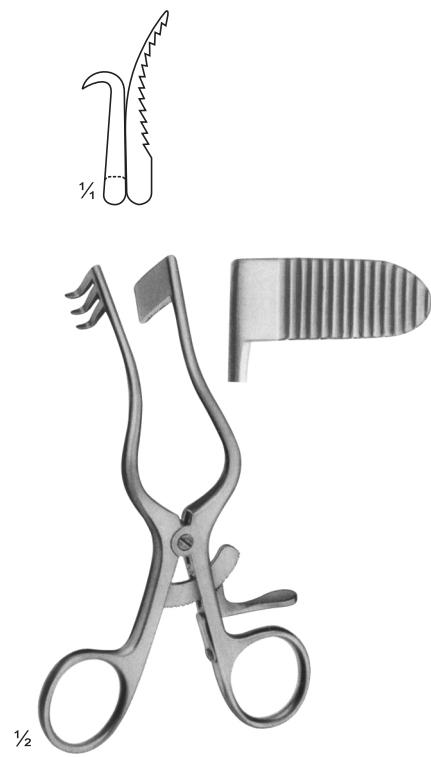

**SF-04-112**  
PERKINS  
Blunt  
130 mm



**SF-04-113**  
ADSON-BABY  
Blunt  
140 mm

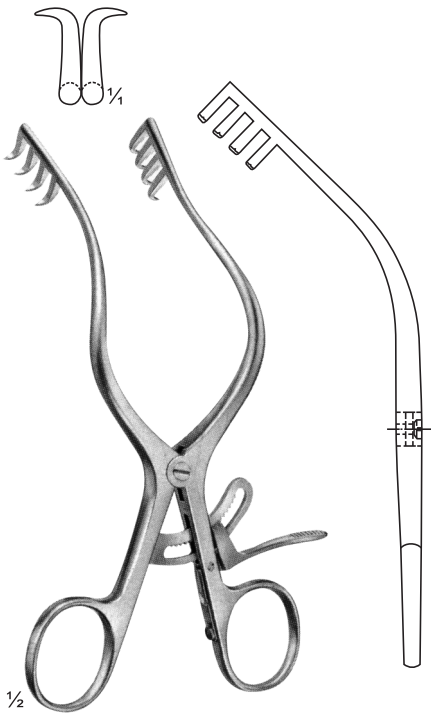

**SF-04-114**  
MOLLISON  
Sharp  
155 mm

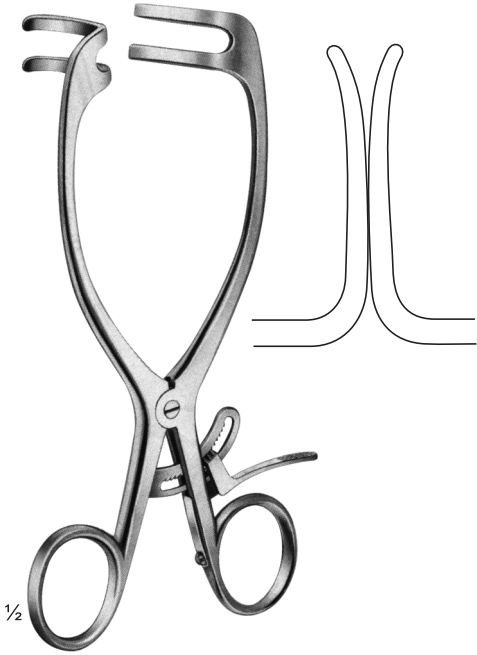

**SF-04-115**  
MAYO-ADAMS  
165 mm

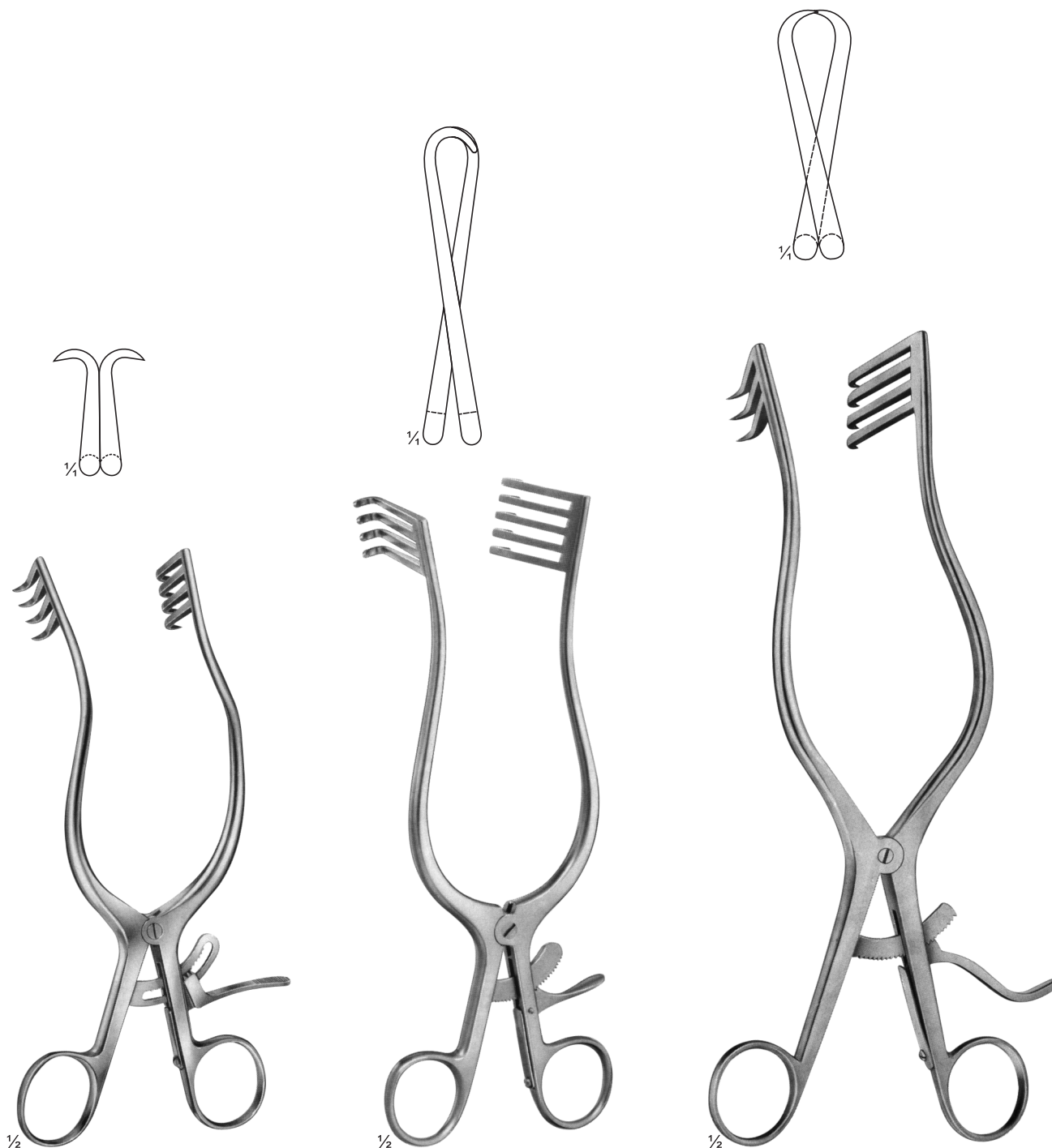

**SF-04-116**  
ANDERSON-ADSON  
Sharp  
190 mm

**SF-04-117**  
NORFOLK and  
NORWICH  
Blunt  
220 mm

**SF-04-118**  
ADSON  
Sharp  
265 mm

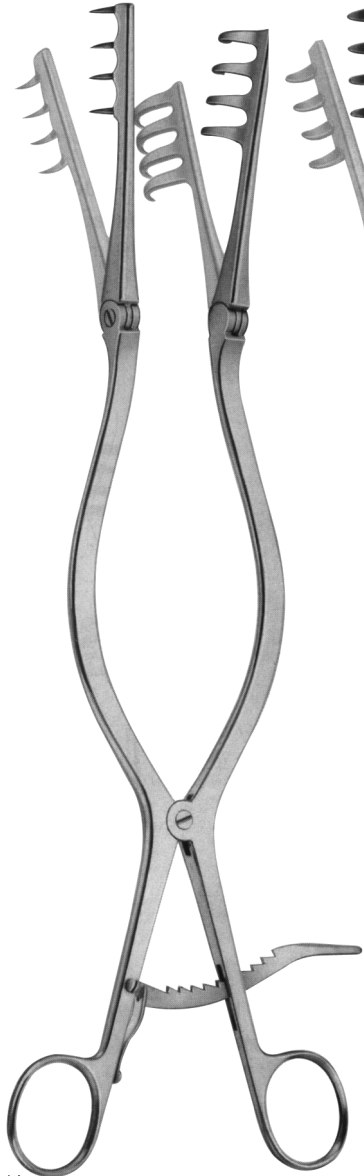
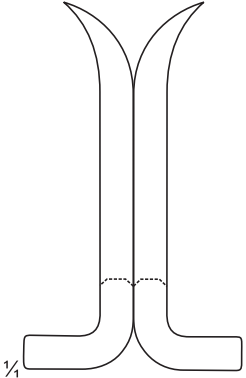
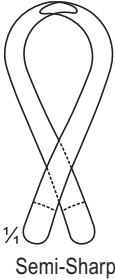
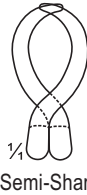
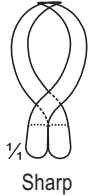

1/2  
**SF-04-119**  
BECKMANN-ADSON  
Sharp  
310 mm

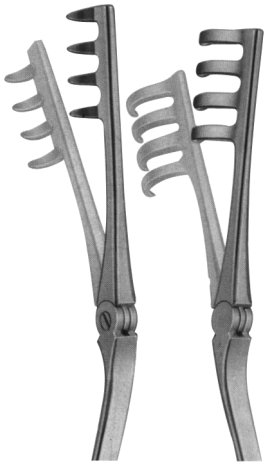

**SF-04-119A**  
BECKMANN-ADSON  
Semi-Sharp  
310 mm



1/2  
**SF-04-120**  
ADSON  
Semi-Sharp  
320 mm

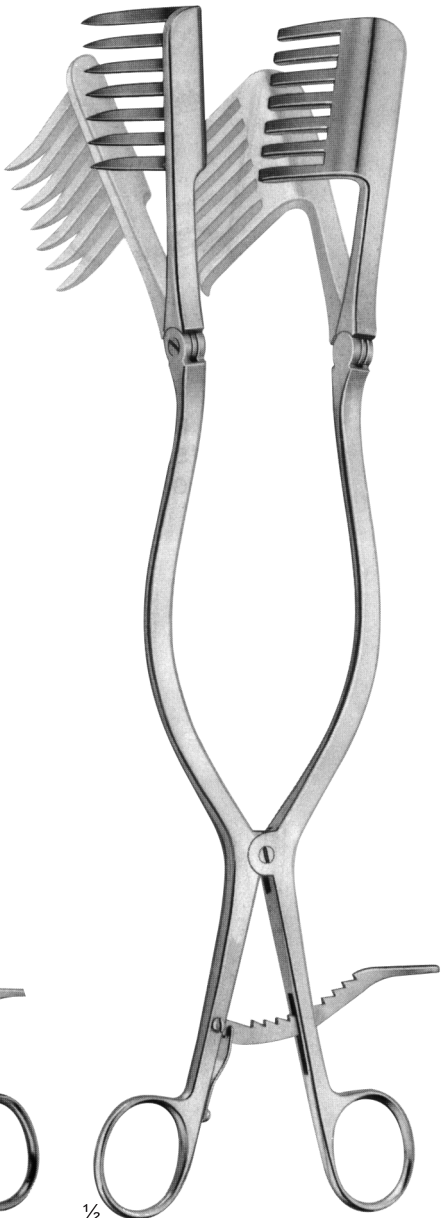

1/2  
**SF-04-121**  
BECKMANN-EATON  
Sharp  
320 mm

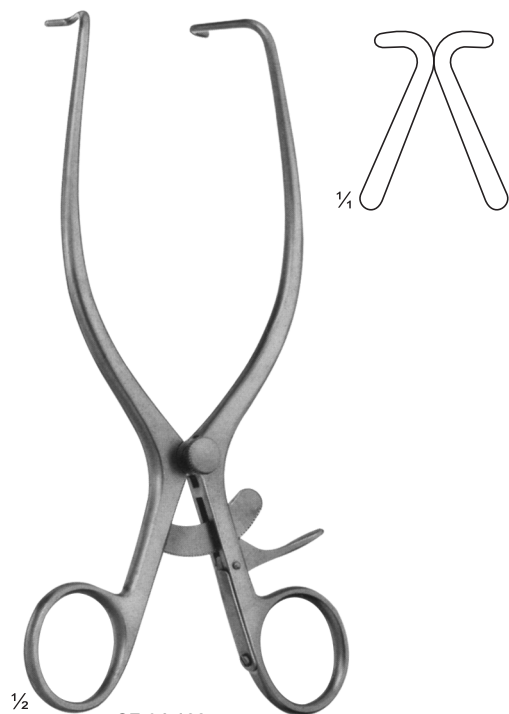

**SF-04-122**  
JACKSON BURROWS  
Retractor, blunt  
185 mm



**SF-04-123**  
GELPI  
Vaginal Retractor  
135 mm



**SF-04-124**  
GELPI  
Skin- and Vaginal Retractor  
175 mm



**SF-04-125**  
DE BAKEY  
Femur Retractor  
145 mm

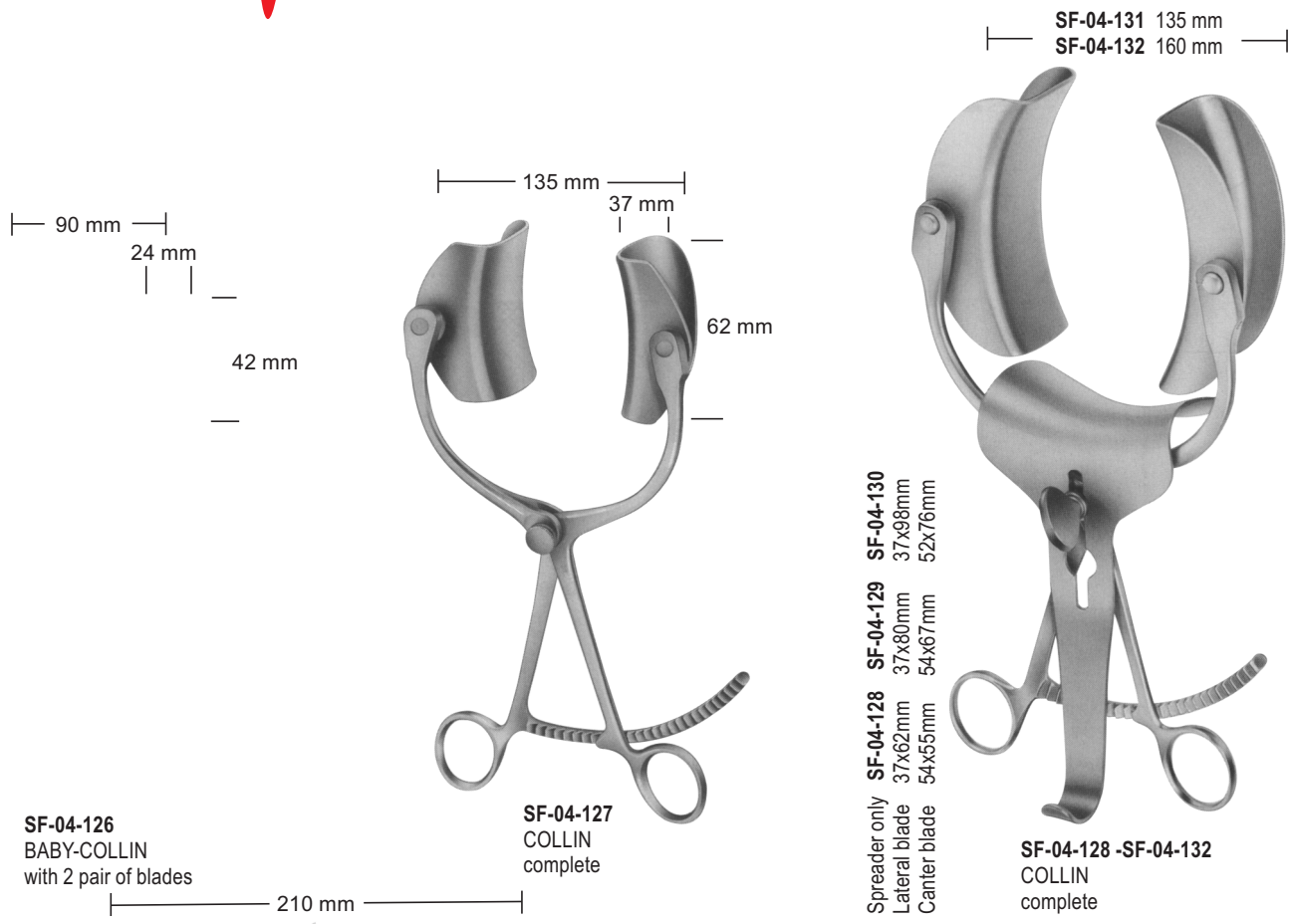

**SF-04-133 - SF-04-134**  
RICARD  
complete  
Spreader only **SF-04-133** **SF-04-134**  
Lateral blade 58x80mm 72x84mm  
Canter blade 54x70mm 72x90mm



**SF-04-135 - SF-04-137**  
HOLZBACH  
Complete  
**SF-04-135** Spreader only  
**SF-04-136** Lateral blade 59x80mm  
**SF-04-137** Canter blade 74x82mm



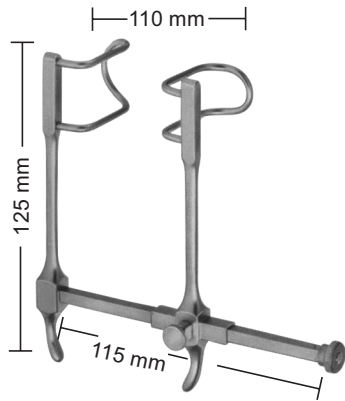

**SF-04-138**  
GOSSET  
Blades:38 mm deep

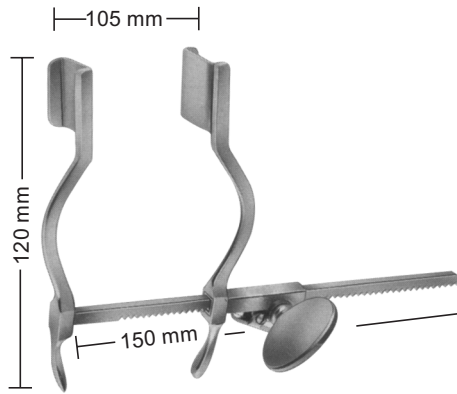

**SF-04-139**  
HERTZLER  
Blades 20 X 25 mm

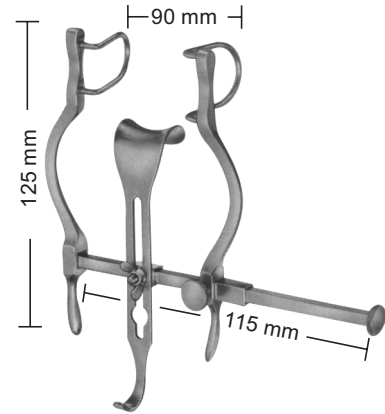

**SF-04-140**  
BALFOUR-BABY  
Lateral blades 27 mm deep  
Center blade 21x24 mm

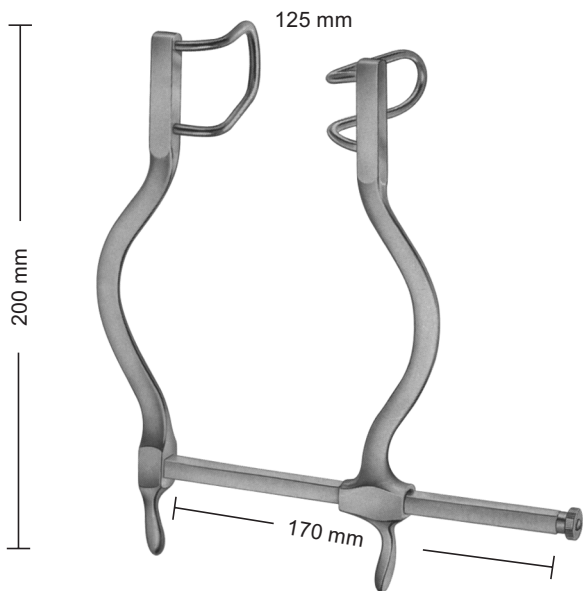

**SF-04-141**  
GOSSET  
Blades:55mm deep

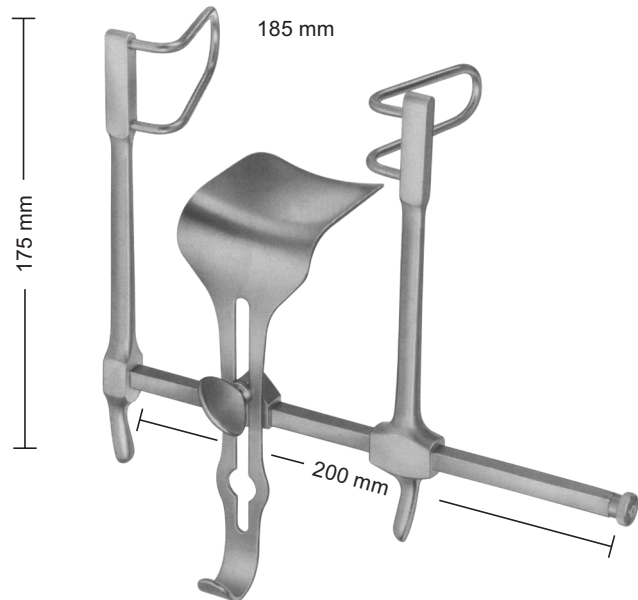

**SF-04-142**  
GOSSET  
Lateral blades 58 mm deep  
Center blade 59 x 57 mm

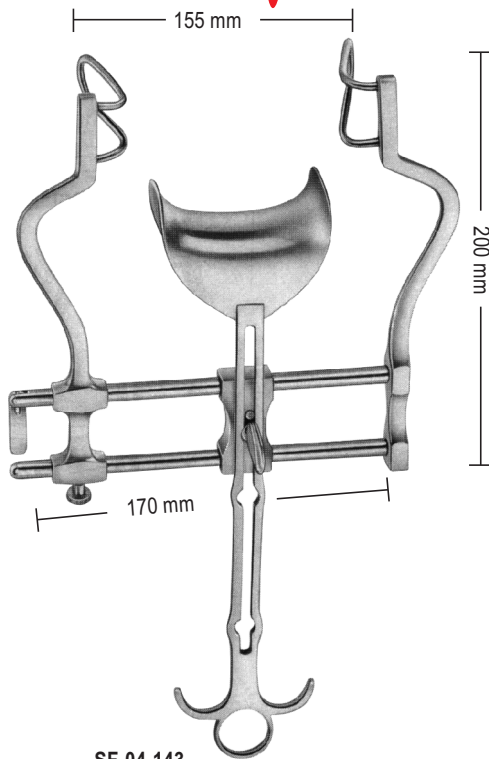

**SF-04-143**  
BALFOUR  
Lateral blades 60 mm deep  
Center blade 47 x 80 mm

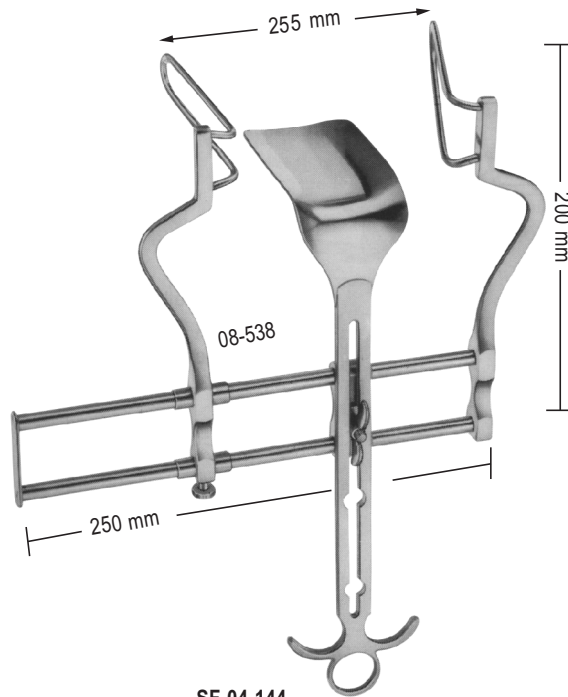

**SF-04-144**  
BALFOUR  
Lateral blades 105 mm deep  
Center blade 107x 59 mm

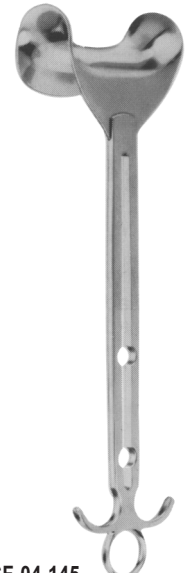

**SF-04-145**  
Center blade only  
54x80 mm

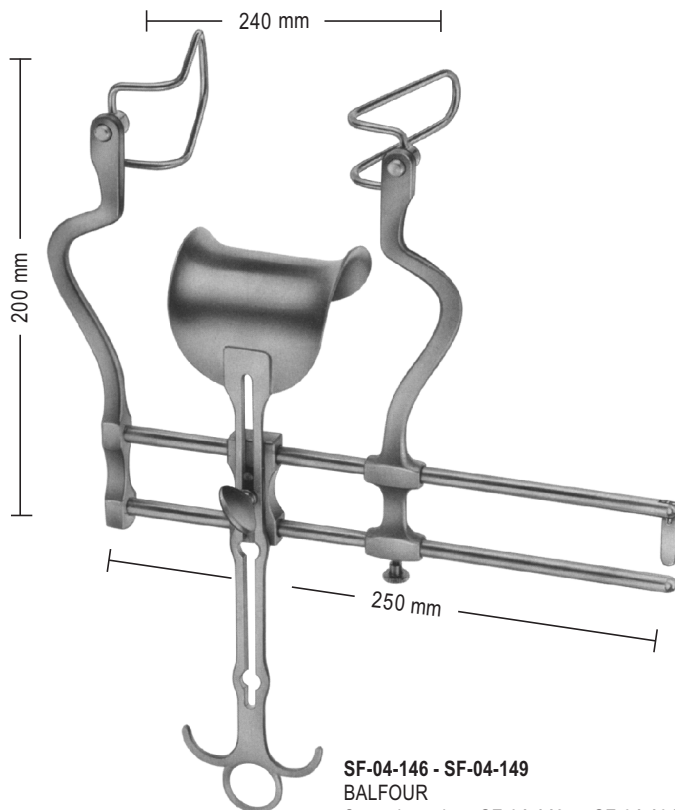

**SF-04-146 - SF-04-149**  
BALFOUR

Spreader only	SF-04-146	SF-04-1047	SF-04-148	SF-04-149
Lateral blades	50 mm	60 mm	75 mm	90 mm
Center blade	47 x 80 mm	62x76 mm	80x80 mm	80x80 mm

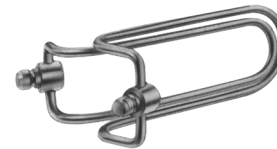

Sales Unit of blades:PR = pair

Lateral blades  
**SF-04-150**  
50 mm deep  
**SF-04-151**  
60 mm deep  
**SF-04-152**  
75 mm deep  
**SF-04-153**  
90 mm deep



BOSE  
SF-04-154  
60 mm



FINSEN  
SF-04-155  
50 mm



FINSEN  
SF-04-156  
70 mm



FINSEN modif.  
SF-04-157  
75 mm



SF-04-158  
45 mm



SF-04-159  
55 mm



MUELLER  
SF-04-160  
65 mm

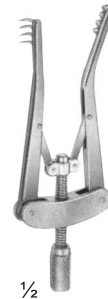

ALM  
SF-04-161 7 cm  
SF-04-162 10 cm



SF-04-161



SF-04-162

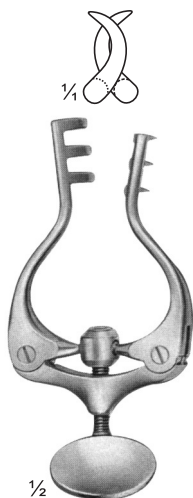

JANSEN  
SF-04-163  
100 mm

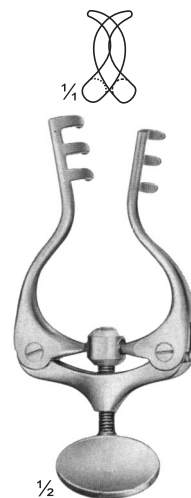

JANSEN  
SF-04-164  
100 mm



ADSON-BABY  
Blunt  
SF-04-165  
14 cm

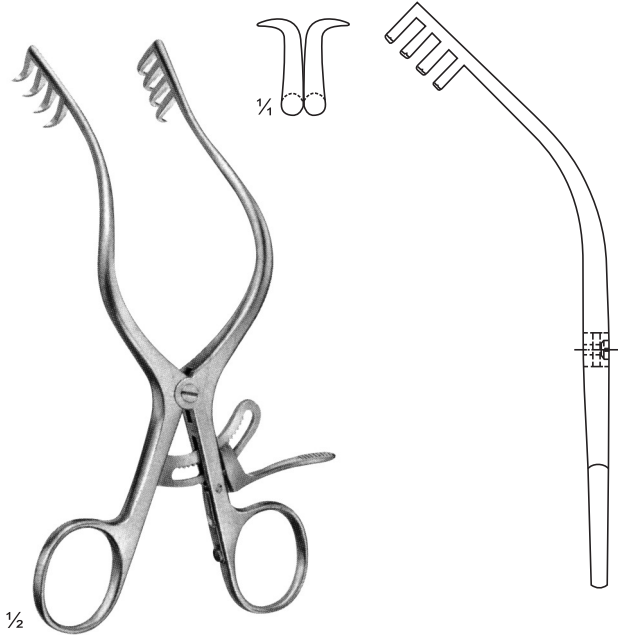

MOLLISON  
Sharp  
SF-04-166  
15.5 cm

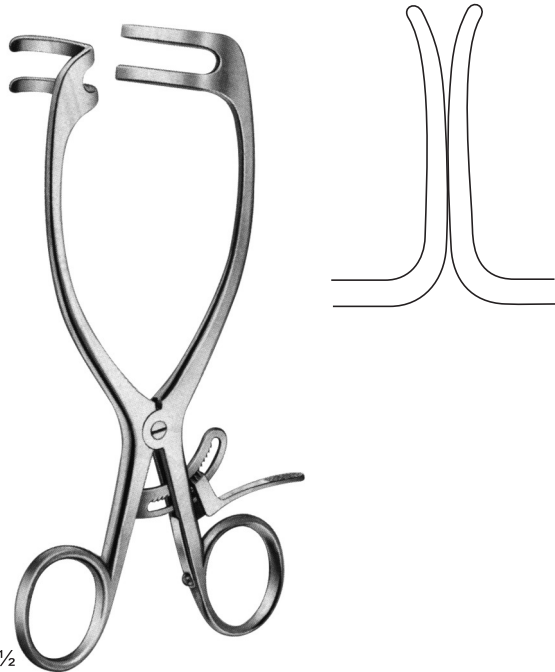

MAYO-ADAMS  
SF-04-167  
16.5 cm



TRAVERS  
SF-04-168  
21.5 cm

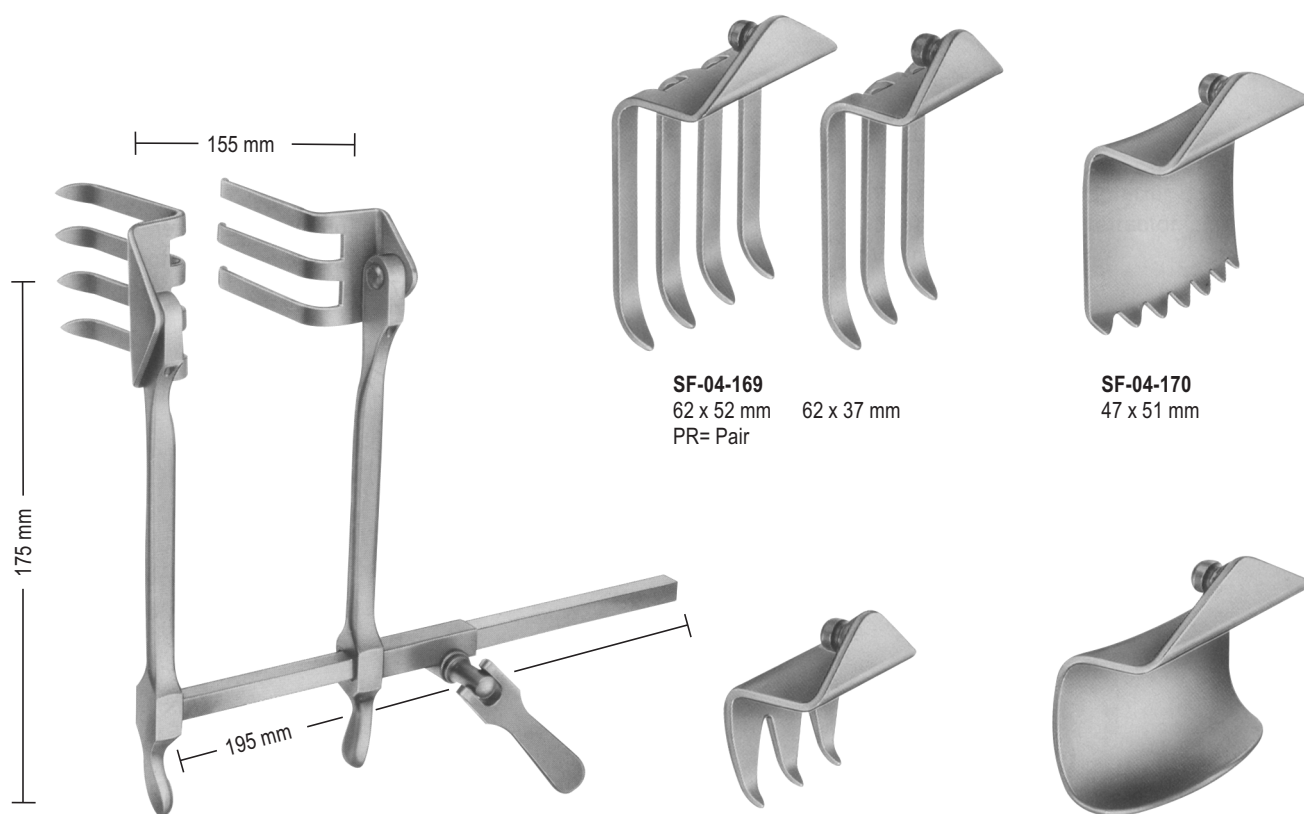

**SF-04-169 - SF-04-172**  
SCOVILLE-RICHTER  
Retractor with 1 pair  
blades reversible type.  
The Retractor bar and  
shanks may be easily  
rotated 180 when  
blades are in situ.

**SF-04-169**  
62 x 52 mm    62 x 37 mm  
PR= Pair

**SF-04-170**  
47 x 51 mm

**SF-04-171**  
30 x 40 mm

**SF-04-172**  
37 x 62 mm

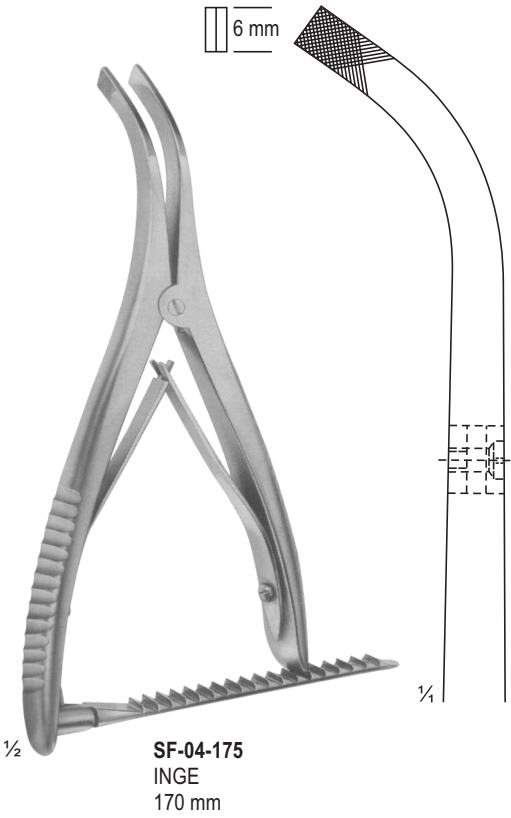
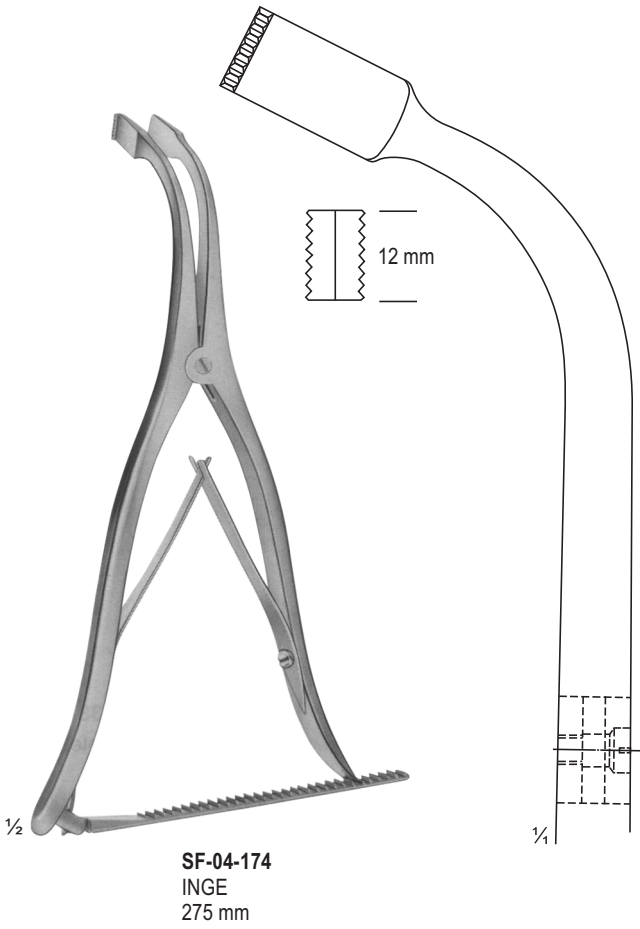
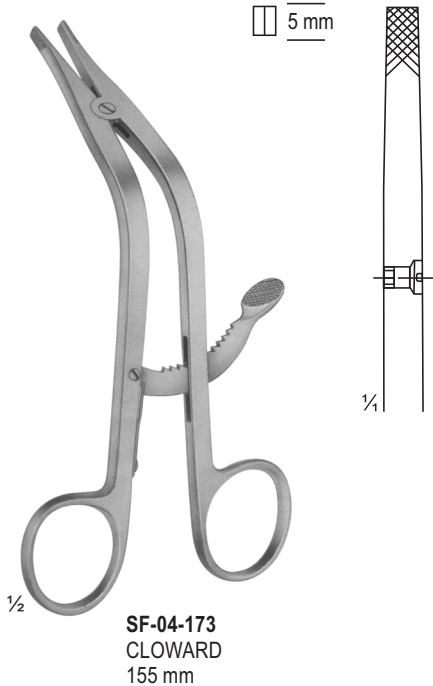

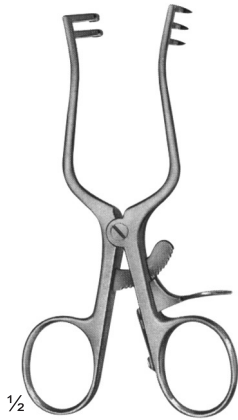

WEITLANER  
Sharp  
SF-04-176  
11 cm

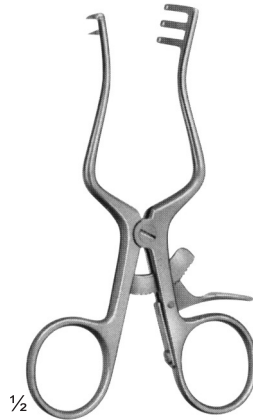

WEITLANER  
Semi-Sharp  
SF-04-177  
11 cm



WEITLANER  
Blunt  
SF-04-178  
11 cm



WEITLANER  
Sharp  
SF-04-179  
13 cm

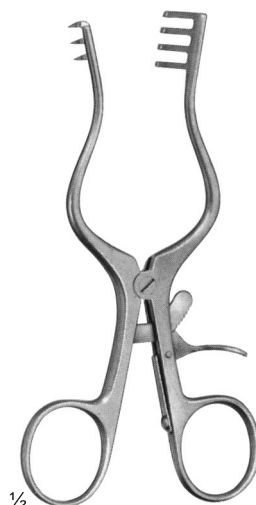

WEITLANER  
Semi-Sharp  
SF-04-180  
13 cm

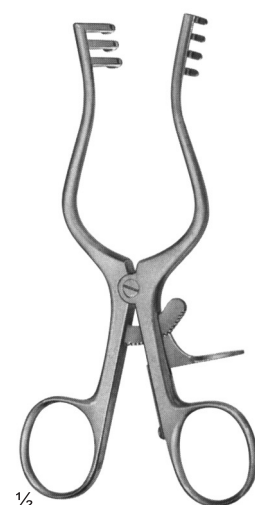

WEITLANER  
Blunt  
SF-04-181  
13 cm



HENLEY  
Complete with 3 Central Baldes  
SF-04-182 - SF-04-184  
16.5 cm

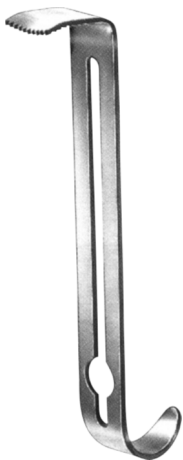
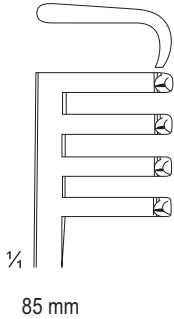

Blades  
SF-04-182  
19 X 17 mm

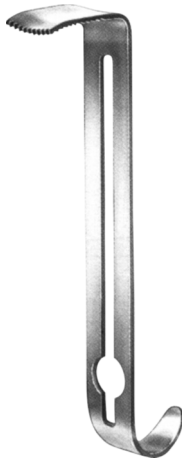

Blades  
SF-04-183  
25 X 17 mm

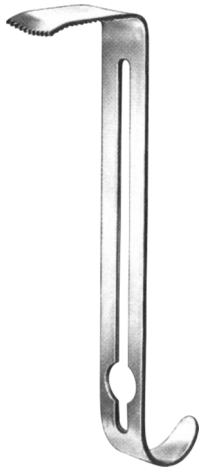

Blades  
SF-04-184  
32 X 17 mm





1/2

JOLL ( FRIEDMAN )  
**SF-04-185**  
 Thyroid and Vaginal Retractor  
 15.5 cm

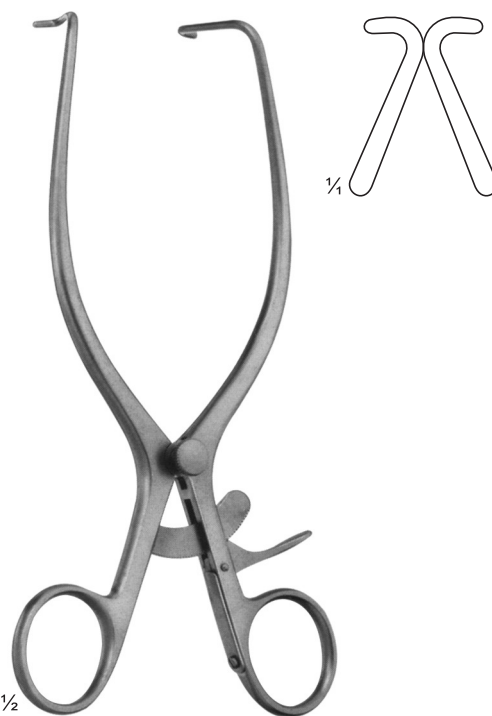

1/2

JACKSON BURROWS  
**SF-04-186**  
 Retractor, blunt  
 18.5 cm

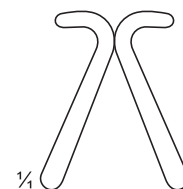

1/4

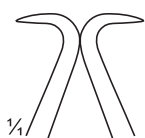

1/4



1/2

GELPI  
**SF-04-187**  
 13.5 cm

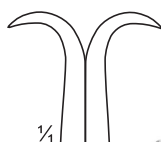

1/4



1/2

GELPI  
**SF-04-188**  
 17.5 cm

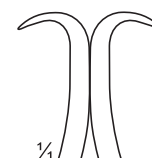

1/4



1/2

DE BAKHEY  
**SF-04-189**  
 14.5 cm

1/2

O'SULLIVAN-O'CONNOR  
SF-04-190 - SF-04-192

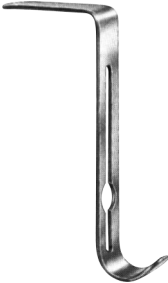

1



2



3

Blades for  
Fig. 1 = SF-04-190 45 X 17 mm  
Fig. 2 = SF-04-191 90 X 37 mm  
Fig. 3 = SF-04-192 90 X 45 mm



CLOWARD modif.  
Spreader Only  
SF-04-193 - SF-04-202

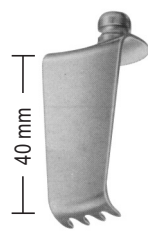

16 mm  
SF-04-193

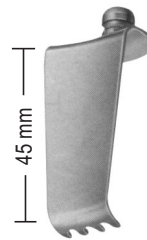

16 mm  
SF-04-194

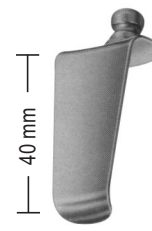

16 mm  
SF-04-195

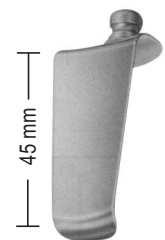

16 mm  
SF-04-196

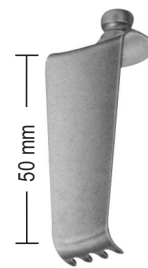

16 mm  
SF-04-197

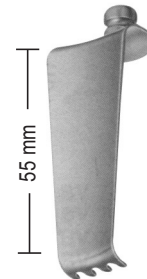

16 mm  
SF-04-198

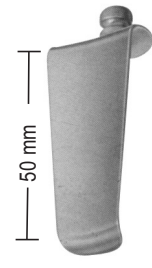

16 mm  
SF-04-199

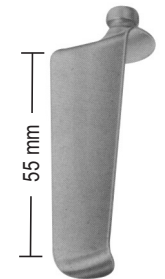

16 mm  
SF-04-200

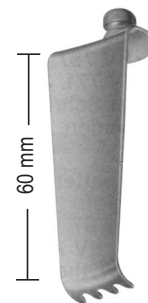

16 mm  
SF-04-201

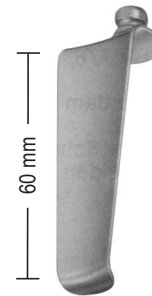

16 mm  
SF-04-202



CLOWARD-TYPE  
**SF-04-203**  
 25.5 cm  
 with ball snap closure Cervical Retractor  
 complete consisting of Retractor Body  
 25.5 cm, 110 mm spread (without blades)



**SF-04-204 - SF-04-208**  
**SF-04-204** 15 x 40 mm  
**SF-04-205** 15 x 45 mm  
**SF-04-206** 15 x 50 mm  
**SF-04-207** 15 x 55 mm  
**SF-04-208** 15 x 60 mm  
 serrated



**SF-04-209 - SF-04-213**  
**SF-04-209** 15 x 40 mm  
**SF-04-210** 15 x 45 mm  
**SF-04-211** 15 x 50 mm  
**SF-04-212** 15 x 55 mm  
**SF-04-213** 15 x 60 mm  
 Blunt

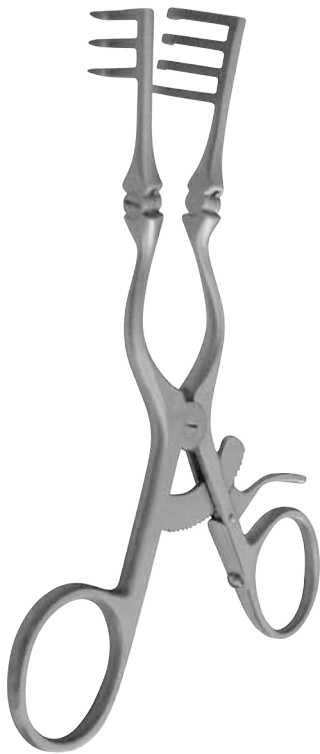

CONE  
**SF-04-214 - SF-04-221**  
**SF-04-214** 14 cm, 18 mm 3 x 4  
**SF-04-215** 16 cm, 18 mm 3 x 4  
**SF-04-216** 20 cm, 20 mm 3 x 4  
**SF-04-217** 24 cm, 27 mm 3 x 4  
**SF-04-218** 14 cm, 18 mm 3 x 4  
**SF-04-219** 16 cm, 18 mm 3 x 4  
**SF-04-220** 20 cm, 20 mm 3 x 4  
**SF-04-221** 24 cm, 27 mm 3 x 4  
prongs blunt



MARKHAM-MEYERDING  
**SF-04-222**  
18 cm, 50 x 25 mm left  
Hemilaminectomy Retractor



MARKHAM-MEYERDING  
**SF-04-223**  
18 cm, 50 x 25 mm right  
Hemilaminectomy Retractor

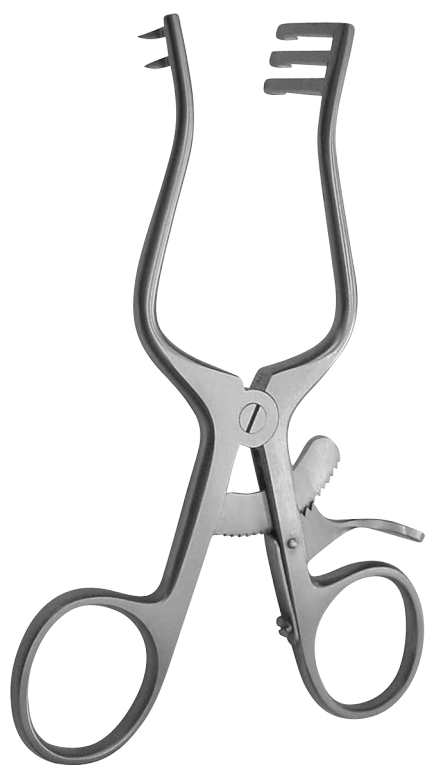

**MINI-WEITLANER**

**SF-04-224 - SF-04-225**

**SF-04-224** 11 cm, 16 mm 2 x 3 prongs sharp

**SF-04-225** 11 cm, 16 mm 2 x 3 prongs blunt



**WEITLANER**

**SF-04-226 - SF-04-233**

**SF-04-226** 13 cm, 18 mm 3 x 4 prongs sharp

**SF-04-227** 16 cm, 18 mm 3 x 4 prongs sharp

**SF-04-228** 20 cm, 21 mm 3 x 4 prongs sharp

**SF-04-229** 25 cm, 27 mm 3 x 4 prongs sharp

**SF-04-230** 13 cm, 18 mm 3 x 4 prongs blunt

**SF-04-231** 16 cm, 18 mm 3 x 4 prongs blunt

**SF-04-232** 20 cm, 21 mm 3 x 4 prongs blunt

**SF-04-233** 25 cm, 27 mm 3 x 4 prongs blunt



**ANDERSON-ADSON**

Cerebellar Retractor

**SF-04-234** 20 cm 4 x 4 prongs sharp



**WEITLANER**

**SF-04-235 - SF-04-236**

**SF-04-235** 26 cm, 27 mm 5 x 6 prongs sharp

**SF-04-236** 26 cm, 27 mm 5 x 6 prongs blunt



**HEMILAMINECTOMY**

**SF-04-237 - SF-04-238**

**SF-04-237** 29 cm, 42 mm 6 x 6 prongs sharp

**SF-04-238** 29 cm, 42 mm 6 x 6 prongs blunt



**SF-04-239 - SF-04-242**

Right blade 42 mm, left blade 22 mm deep

**SF-04-239** 29 cm, 22/42 mm 6 x 6 prongs sharp

**SF-04-240** 29 cm, 22/42 mm 6 x 6 prongs blunt

Right blade 22 mm, left blade 42 mm deep

**SF-04-241** 29 cm, 22/42 mm 6 x 6 prongs sharp

**SF-04-22** 29 cm, 22/42 mm 6 x 6 prongs blunt

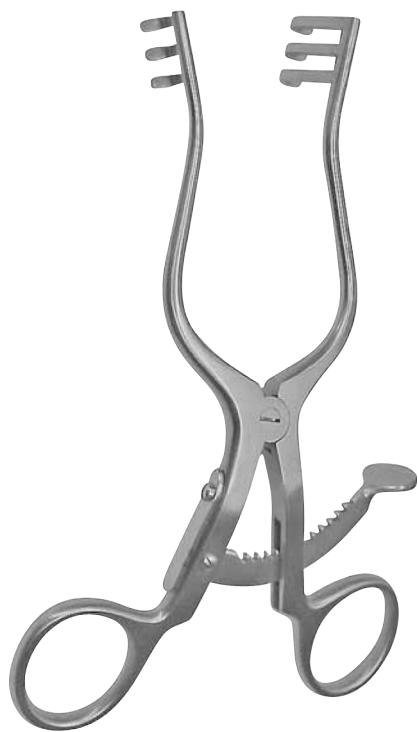

**SCALP CONTOUR**

**SF-04-243 - SF-04-246**

**SF-04-243** 14 cm, 18 mm 1 x 1 prongs blunt

**SF-04-244** 14 cm, 18 mm 3 x 3 prongs blunt

**SF-04-245** 14 cm, 18 mm 3 x 4 prongs sharp

**SF-04-246** 14 cm, 18 mm 3 x 4 prongs blunt



**BECKMANN-ADSON**

**SF-04-247 - SF-04-252**

**SF-04-247** 31 cm, 25 mm 4 x 4 prongs sharp

**SF-04-248** 31 cm, 37 mm 4 x 4 prongs sharp

**SF-04-249** 31 cm, 48 mm 4 x 4 prongs sharp

**SF-04-250** 31 cm, 25 mm 4 x 4 prongs blunt

**SF-04-251** 31 cm, 37 mm 4 x 4 prongs blunt

**SF-04-252** 31 cm, 48 mm 4 x 4 prongs blunt

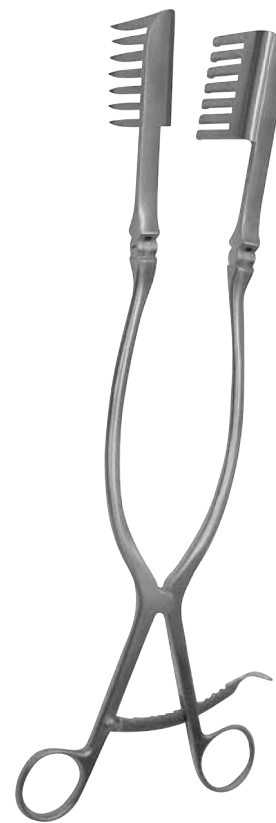

**BECKMANN-EATON**

**SF-04-253**

32 cm, 50 mm 7 x 7 prongs sharp



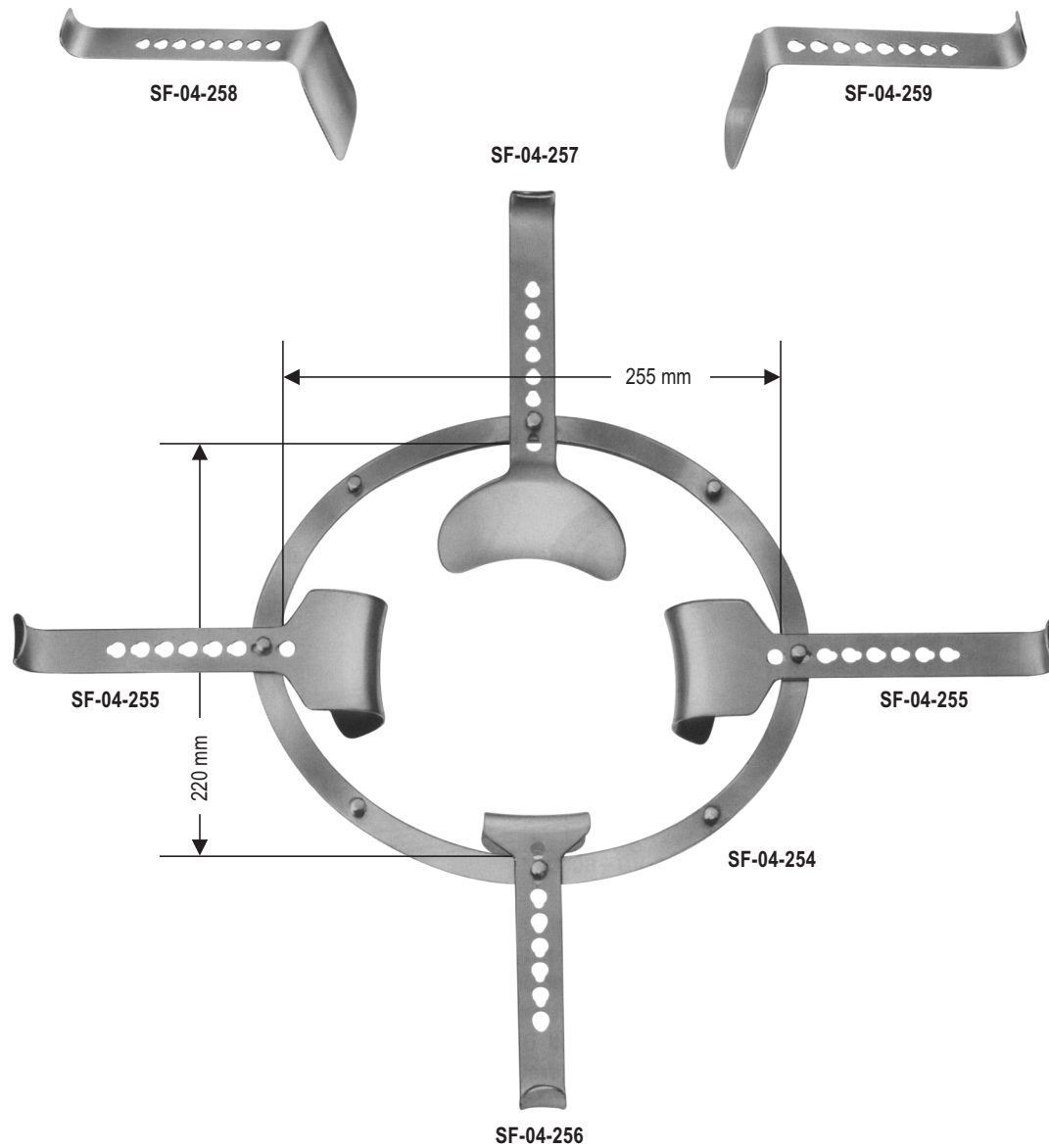

**SF-04-254 - SF-04-259**

SEMM

consisting of:

**SF-04-254** 1 frame 225 x 220 mm

**SF-04-255** 2 blades 46 x 64 mm

**SF-04-256** 1 blade 53 x 54 mm  
(for bladder)

**SF-04-257** 1 blade 82 x 97 mm  
(for intestine)

**SF-04-258** 1 blade 98 x 51 mm  
(for intestine)

**SF-04-259** 1 blade, narrow  
107 x 36 mm

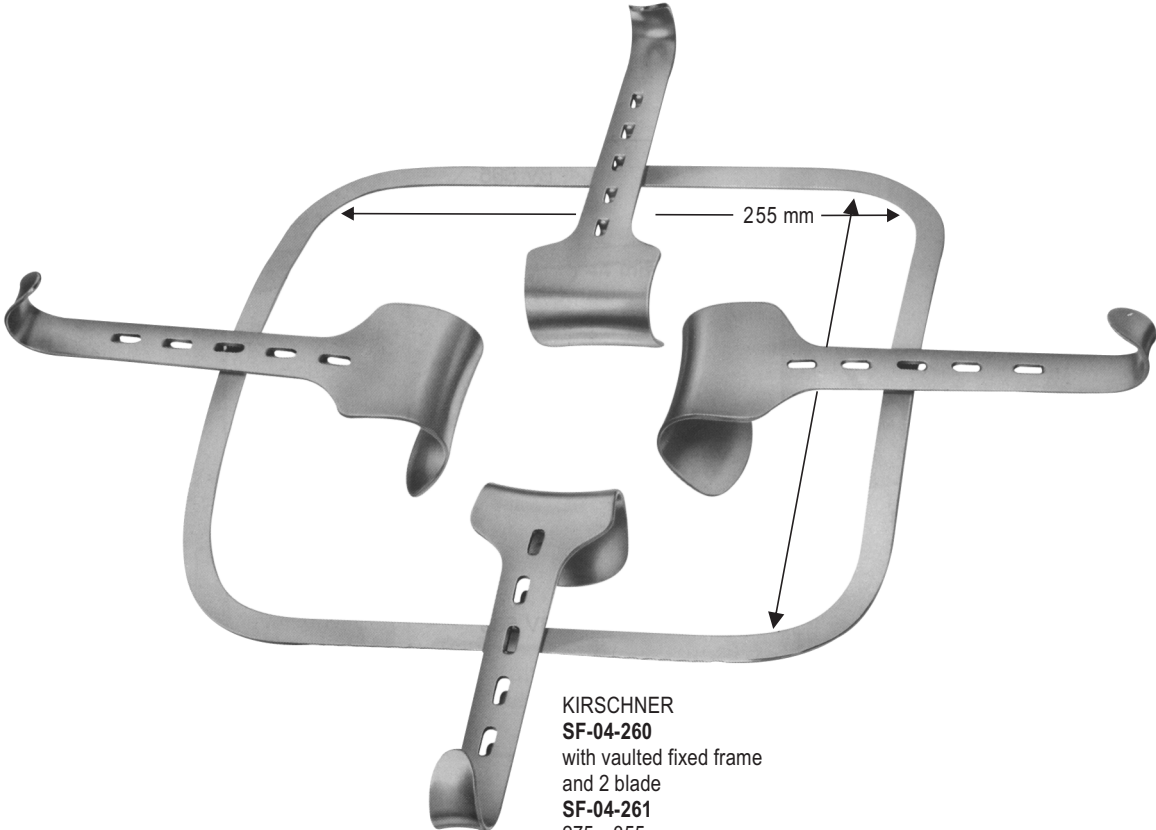

**KIRSCHNER**  
**SF-04-260**  
 with vaulted fixed frame  
 and 2 blade  
**SF-04-261**  
 275 x 355 mm  
 Frame only, over-sized  
**SF-04-262**  
 295 x 275 mm  
 Frame only



**SF-04-263**  
 KIRSCHNER  
 64 x 80 mm



**SF-04-264**  
 KIRSCHNER-BALFOUR  
 80x 82 mm

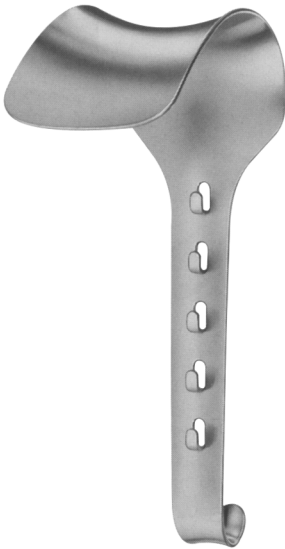

**SF-04-265 - SF-04-267**  
 KIRSCHNER  
**SF-04-265** 90x 69mm  
**SF-04-266** 92x 95mm  
**SF-04-267** 78x 58mm



**SF-04-268 - SF-04-270**  
 KIRSCHNER  
**SF-04-268** 108x42mm  
**SF-04-269** 91x 55mm  
**SF-04-270** 121x 55mm



# Surgiforce Instruments



Opposite Surgical Association,  
Malkay Kalan, Marala Road,  
Sialkot-51050 Pakistan.



+92 523 559131



info@surgiforce.com  
sales@surgiforce.com



www.surgiforce.com



## Our Certifications:

ISO 9001

CE Certified

EN 13485:2012

ISO 7153-1

ISO 7151

ISO 17664:2004

ISO 13402

ISO 15223

