

Page
157–185

- Haemostatic Forceps

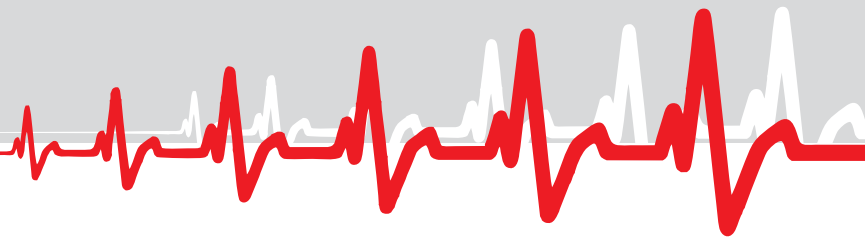

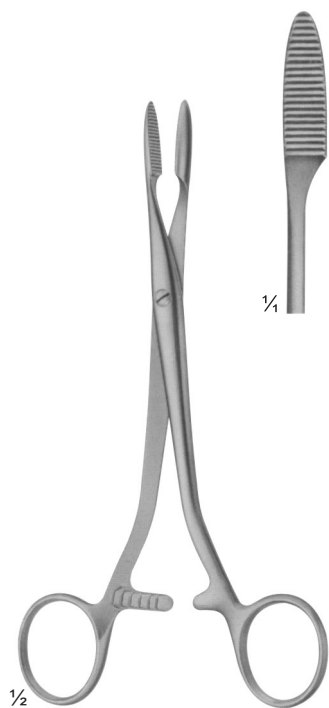

PEAN
SF-09-101 160 mm
SF-09-102 180 mm

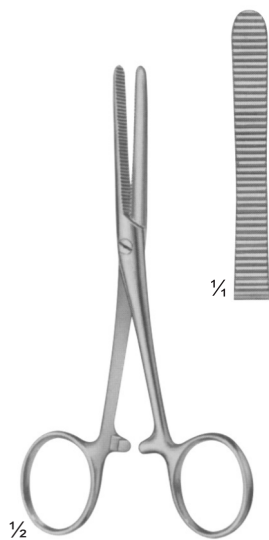

PEAN
SF-09-103 125 mm

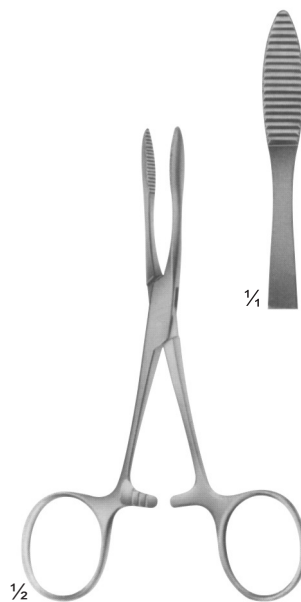

PEAN
SF-09-104 125 mm
SF-09-105 140 mm

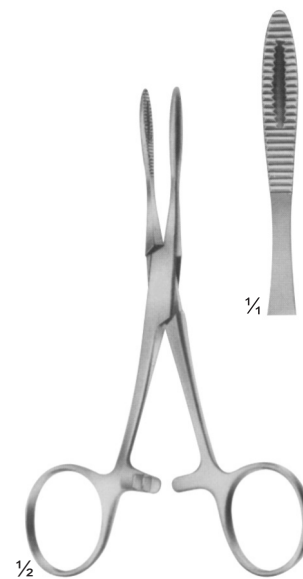

KRONLEIN
SF-09-106 130 mm



SPENCER-WELLS
SF-09-107 - SF-09-113
SF-09-107 130 mm
SF-09-108 140 mm
SF-09-109 150 mm
SF-09-110 180 mm
SF-09-111 200 mm
SF-09-112 250 mm
SF-09-113 300 mm

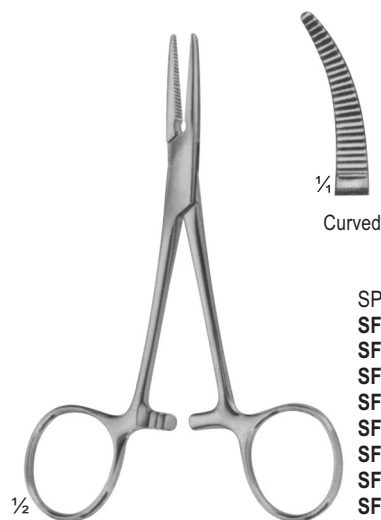

SPENCER-WELLS
SF-09-114 - SF-09-120
SF-09-114 130 mm
SF-09-115 140 mm
SF-09-116 150 mm
SF-09-117 180 mm
SF-09-118 200 mm
SF-09-119 250 mm
SF-09-120 300 mm

DELICATE HAEMOSTATIC FORCEPS

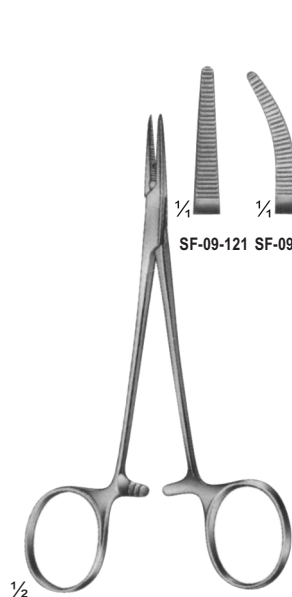

SF-09-121 - SF-09-124
HALSTED-MOSQUITO
125 mm

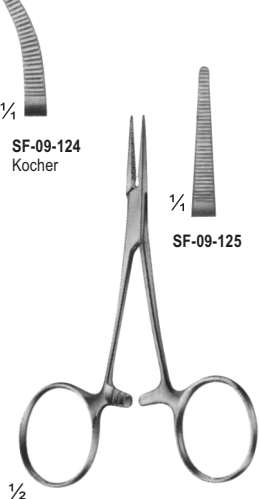

SF-09-125 - SF-09-128
BABY-MOSQUITO
(HARTMANN)
100 mm

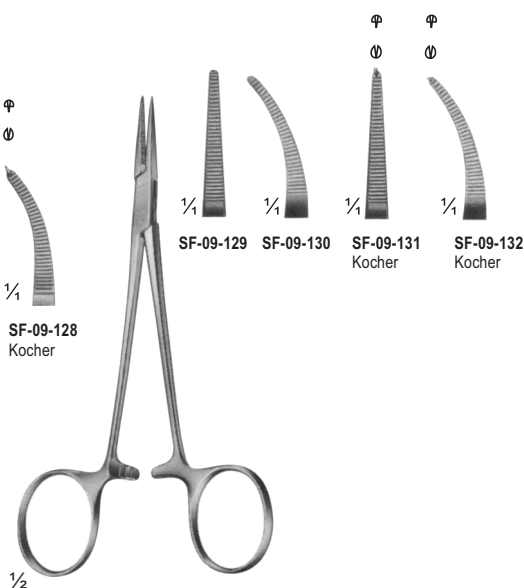

SF-09-129 - SF-09-132
MICRO-HALSTED
125 mm

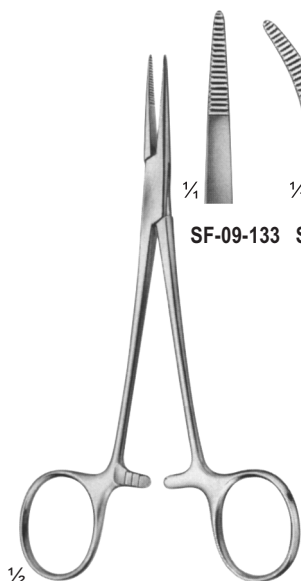

SF-09-133 - SF-09-134
PROVIDENCE-HOSPITAL
140 mm



SF-09-135 - SF-09-136
KELLY
140 mm

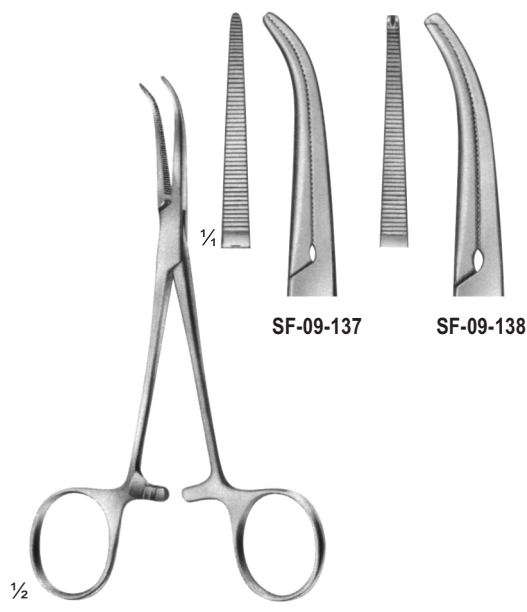

SF-09-137 - SF-09-138
DANDY
Curved sideways
140 mm

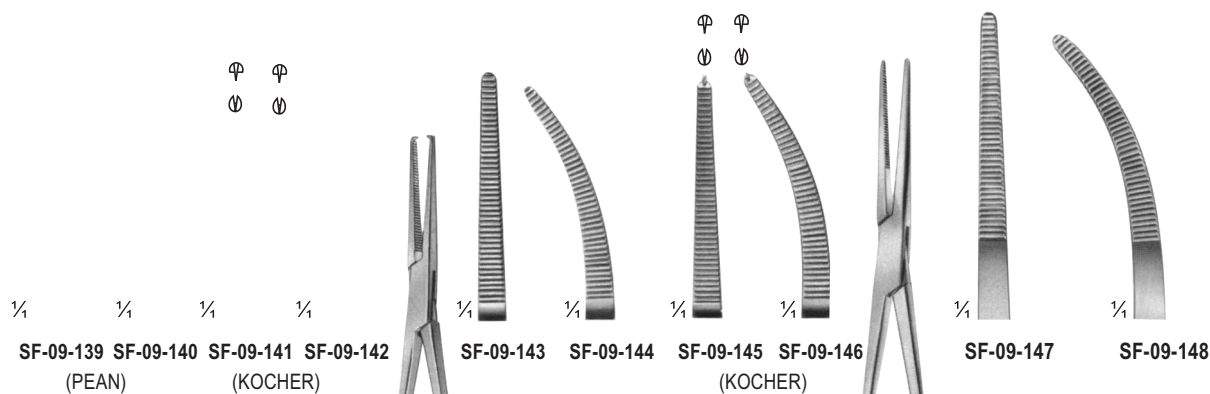

1/2
SF-09-139 - SF-09-142
BABY-CRILE
140 mm

1/2
SF-09-143 - SF-09-146
CRILE
140 mm

1/2
SF-09-147 - SF-09-148
RANKIN
160 mm

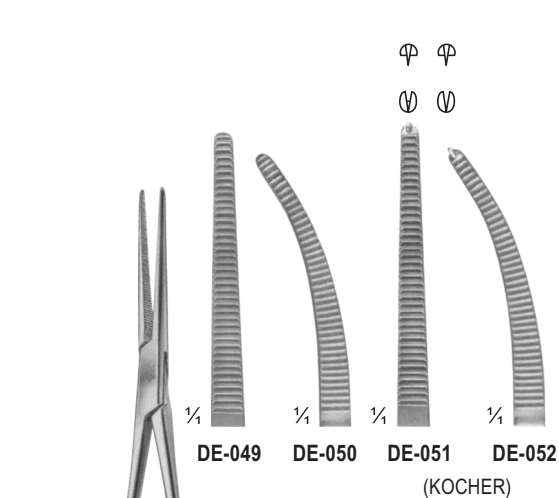

1/2
DE-049 - 052
CRILE
160 mm



1/2
DE-053 - 054
ADSON
185 mm

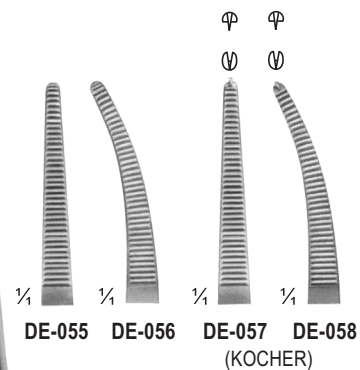

1/2
DE-055 - 058
HALSTED
185 mm

DELICATE HAEMOSTATIC FORCEPS

www.surgiforce.com

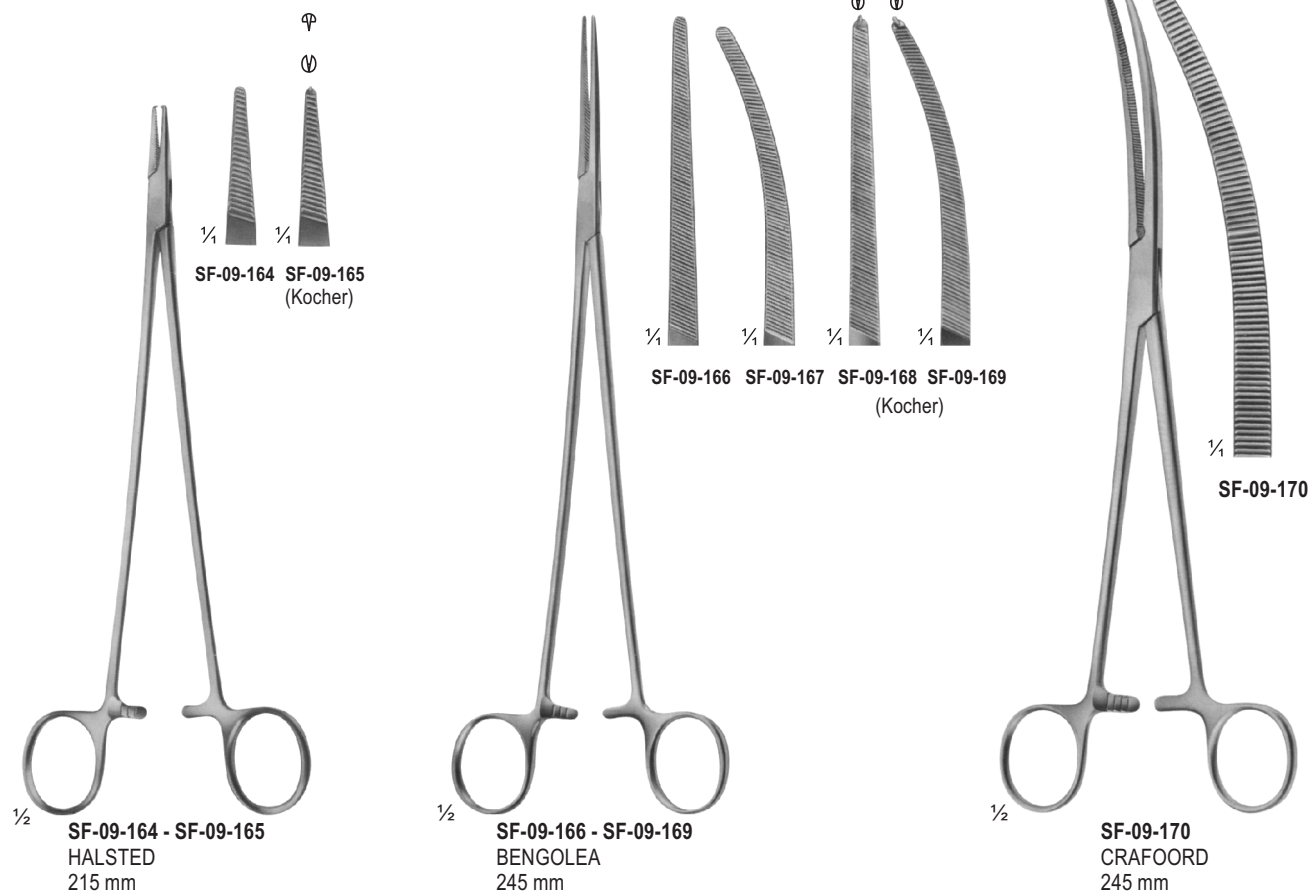
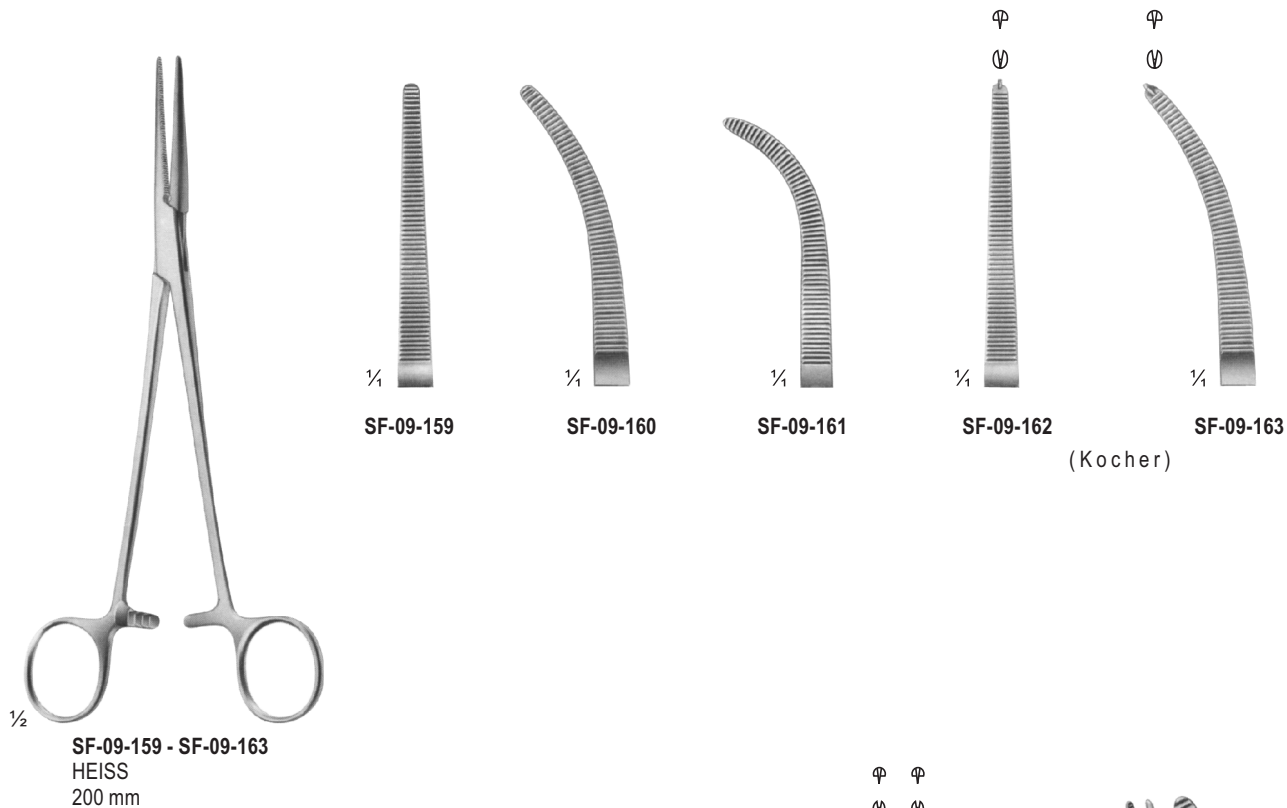

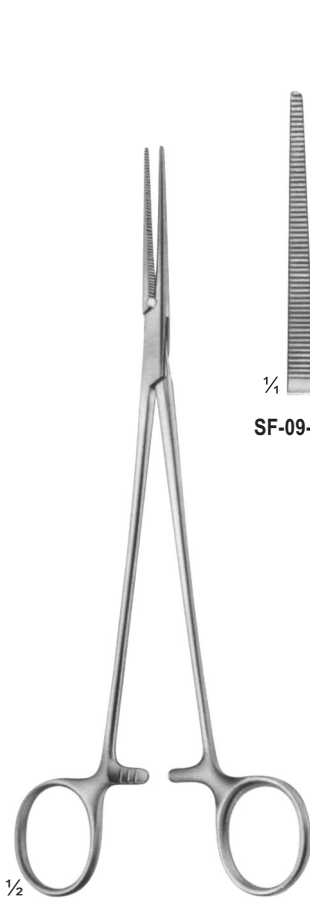

HALSTED-MOSQUITO
SF-09-171 180 mm
SF-09-172 210 mm

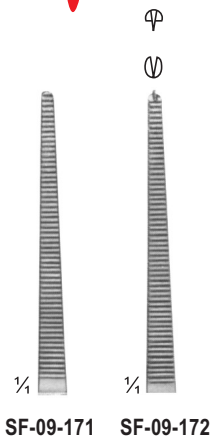

SF-09-171 SF-09-172

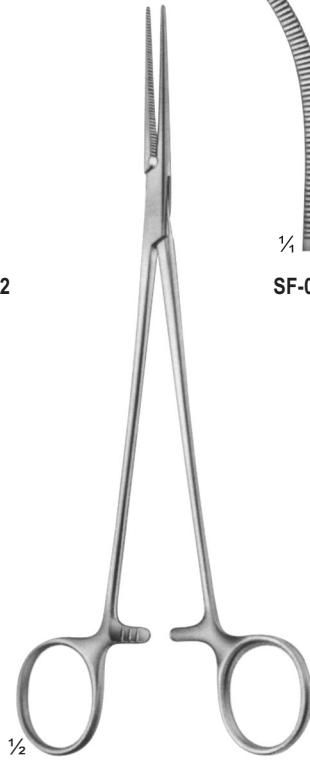

HALSTED-MOSQUITO
SF-09-173 180 mm
SF-09-174 210 mm

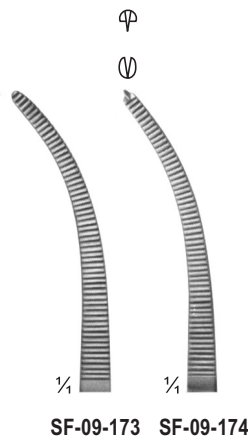

SF-09-173 SF-09-174

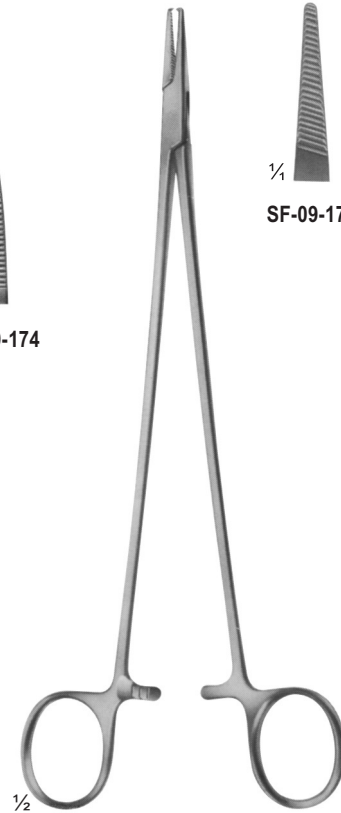

HALSTED
SF-09-175 - SF-09-176
215 mm

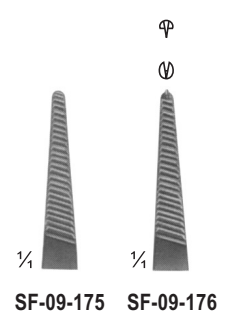

SF-09-175 SF-09-176

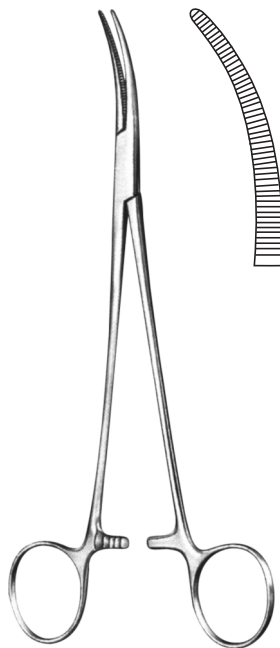

MARTIN-FUCHSIG
SF-09-177
200 mm

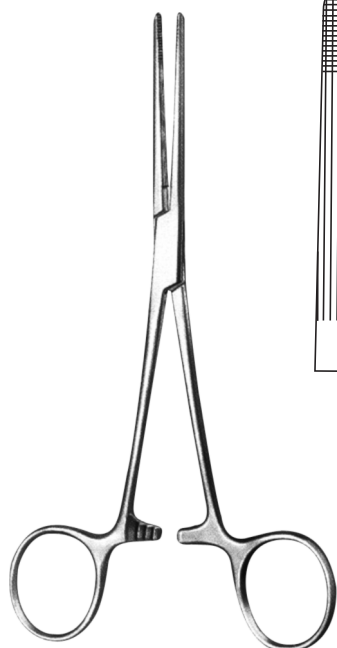

ROCHESTER-CARMALT
SF-09-178 170 mm
SF-09-179 200 mm

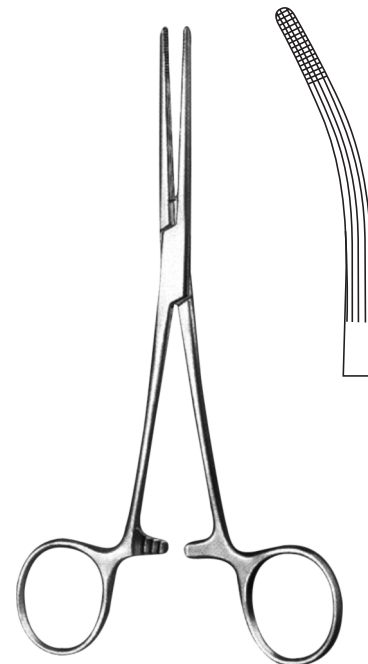

ROCHESTER-CARMALT
SF-09-180 160 mm
SF-09-181 200 mm

HAEMOSTATIC FORCEPS

www.surgiforce.com

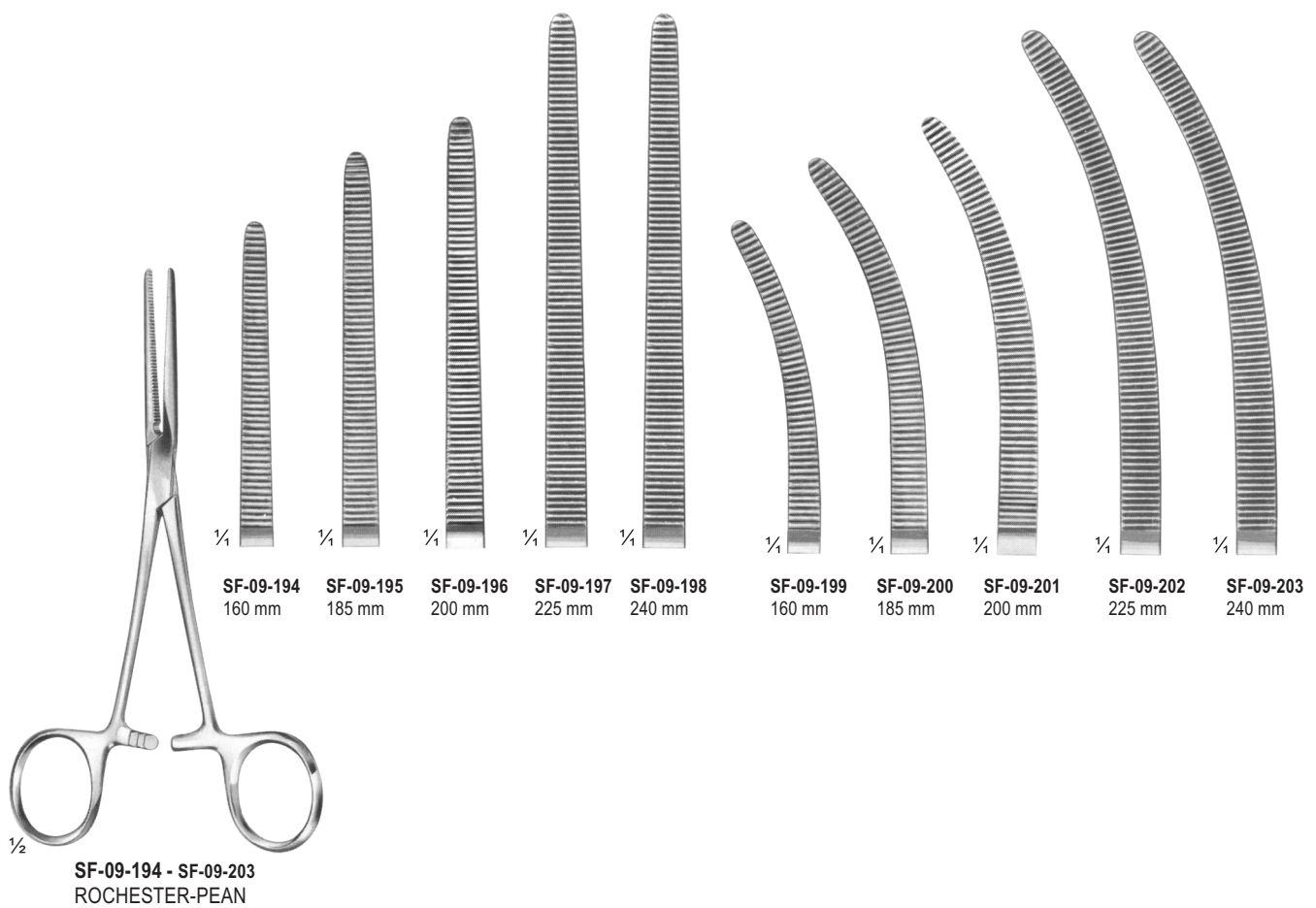
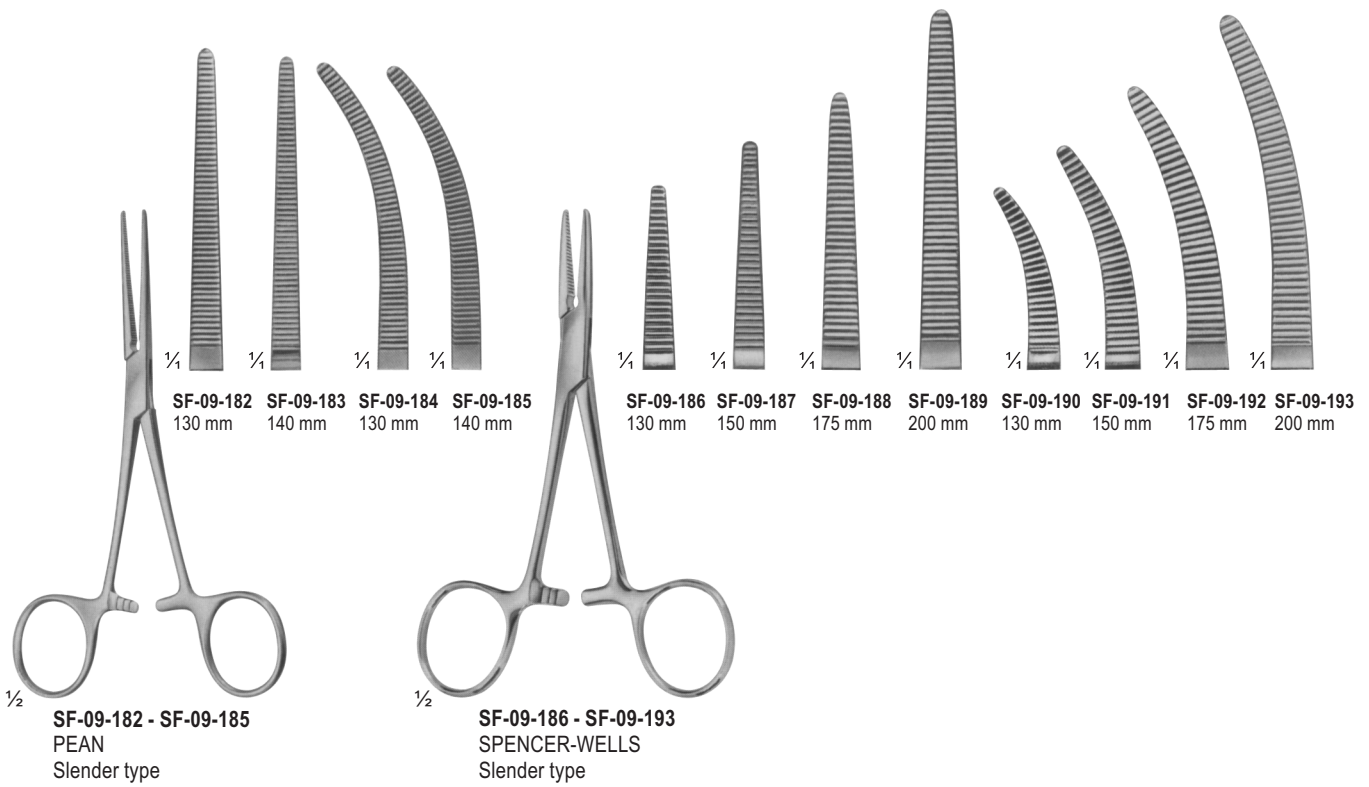

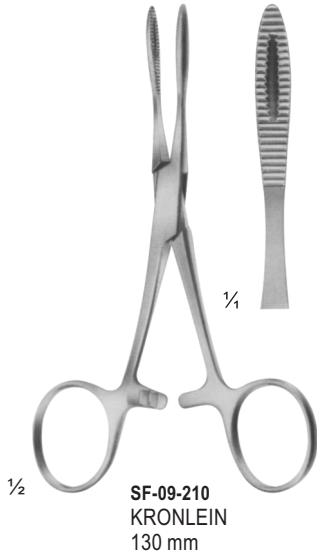
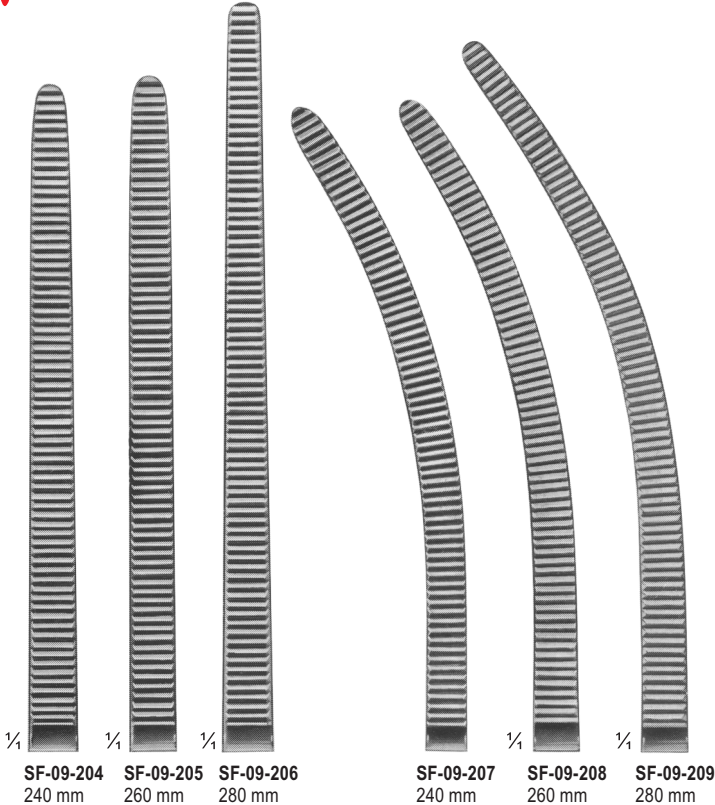

1/2 SF-09-204 - SF-09-209
PEAN

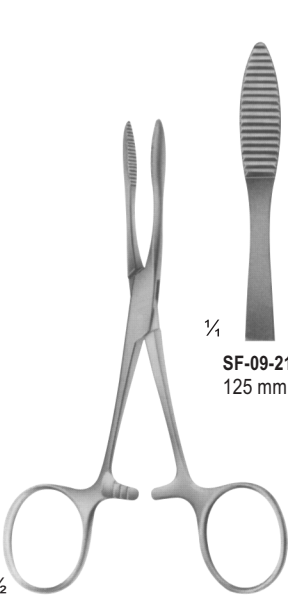

SF-09-211 - SF-09-212
PEAN

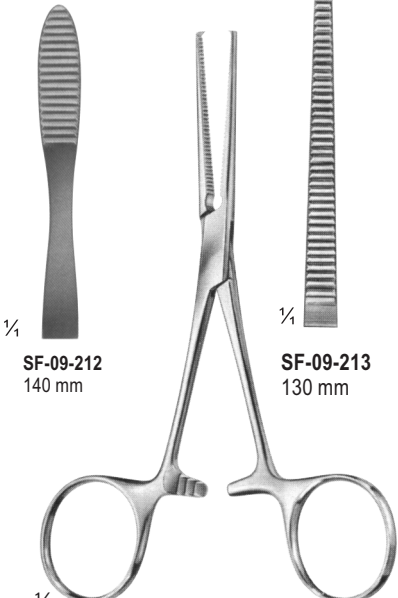

SF-09-213 - SF-09-215
KOCHER

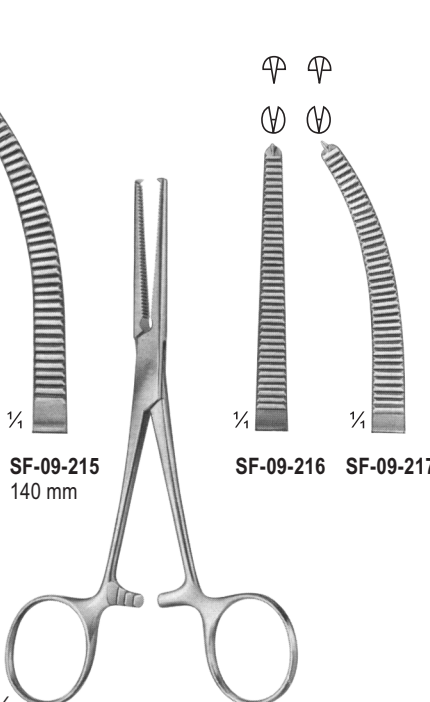

SF-09-216 - SF-09-217
ROCHESTER-OCHSNER
140 mm



1/2
SF-09-218 - SF-09-223
KOCHER-OCHSNER (STR)

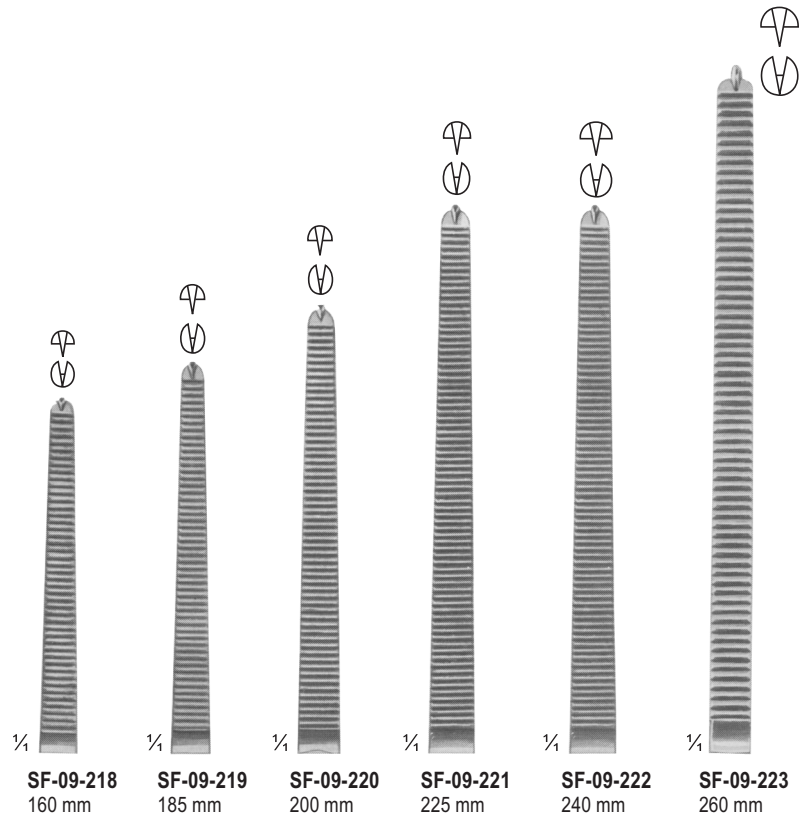

1/2
SF-09-224 - SF-09-229
KOCHER-OCHSNER (CVD)

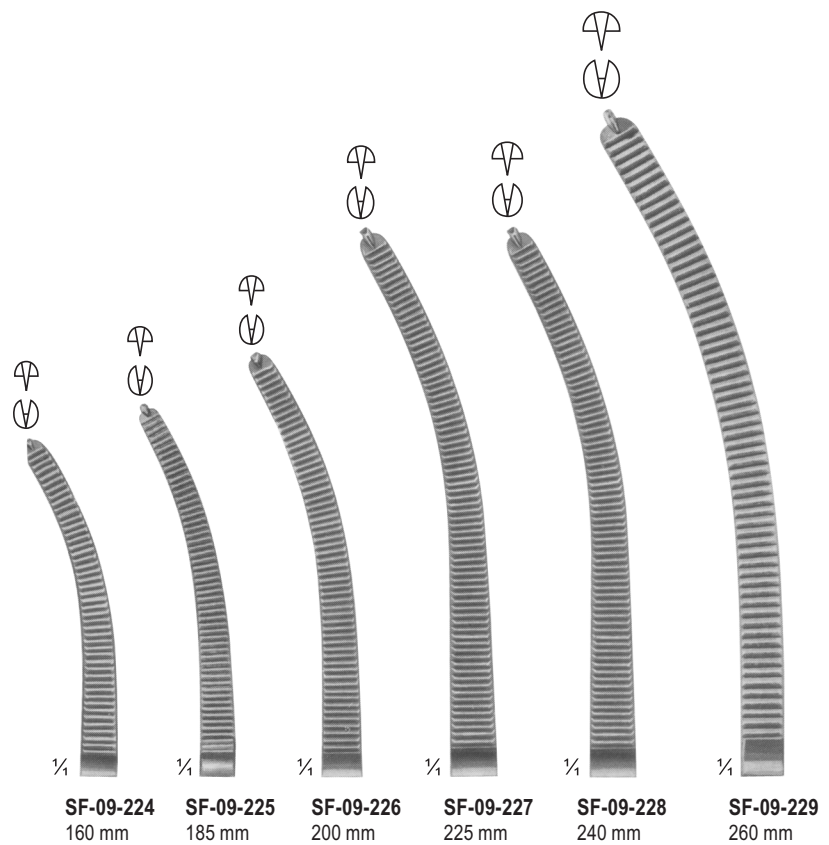

$\frac{1}{4}$ $\frac{1}{4}$ $\frac{1}{4}$ $\frac{1}{4}$
SF-09-230 **SF-09-231** **SF-09-232** **SF-09-233**
 160 mm 200 mm 160 mm 200 mm

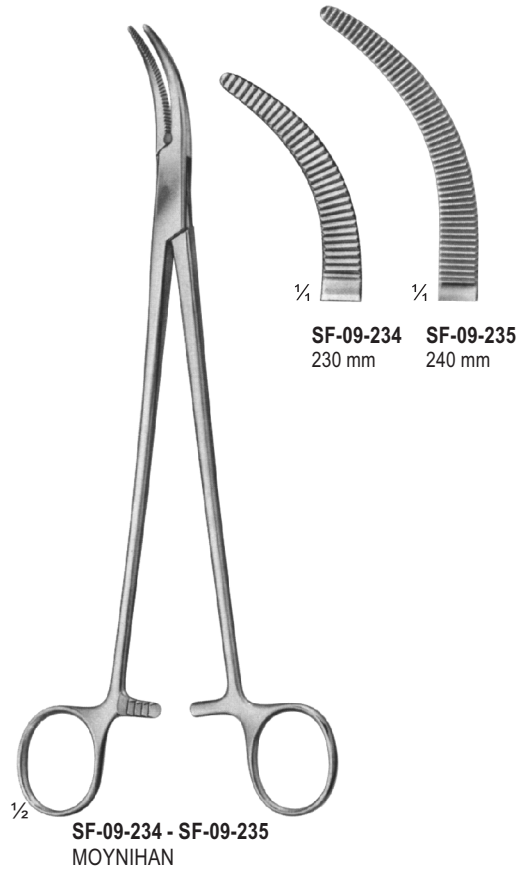

$\frac{1}{2}$ **SF-09-230 - SF-09-233**
 ROCHESTER-CARMALT

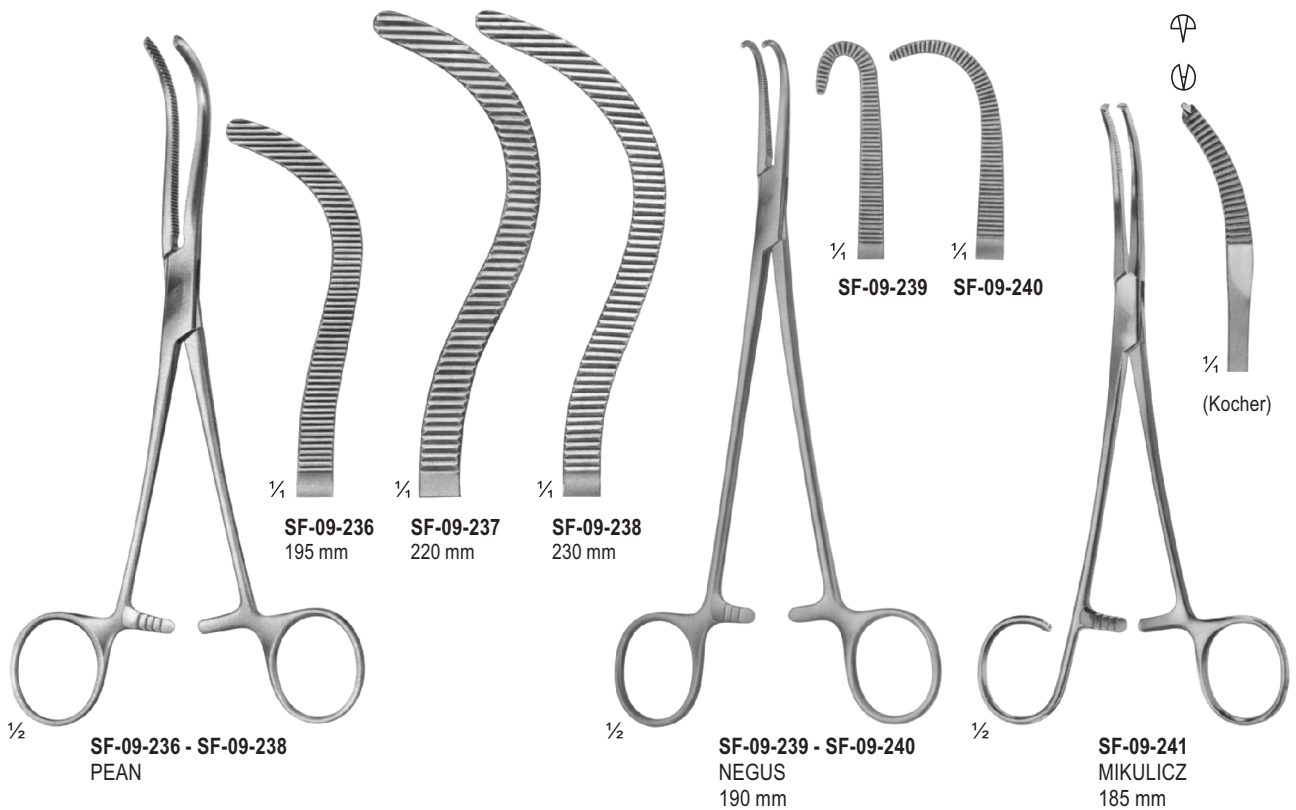

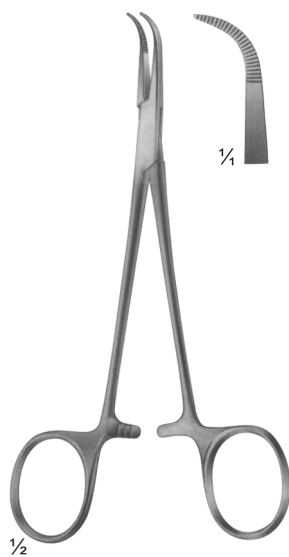

SF-09-242
MICRO-ADSON
140 mm

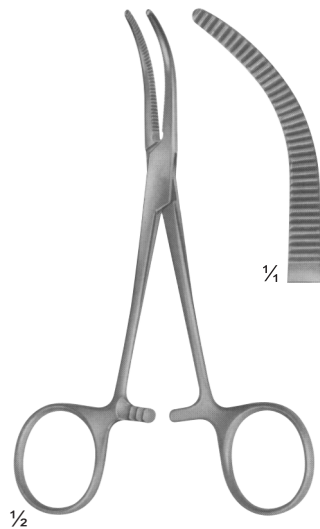

SF-09-243
BABY-OVERHOLT
135 mm

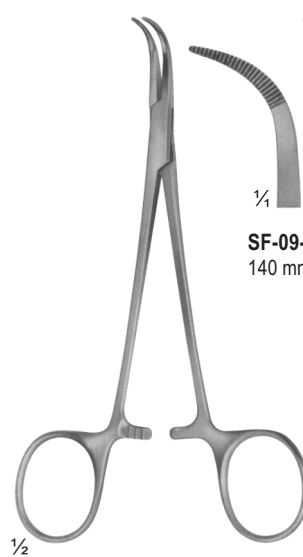

SF-09-244 - SF-09-245
BABY-MIXTER

SF-09-244 140 mm
SF-09-245 180 mm

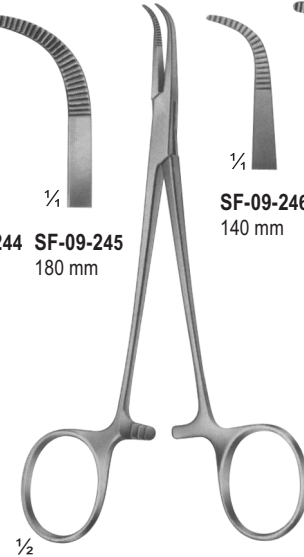

SF-09-246 - SF-09-247
BABY-ADSON

SF-09-246 140 mm
SF-09-247 180 mm

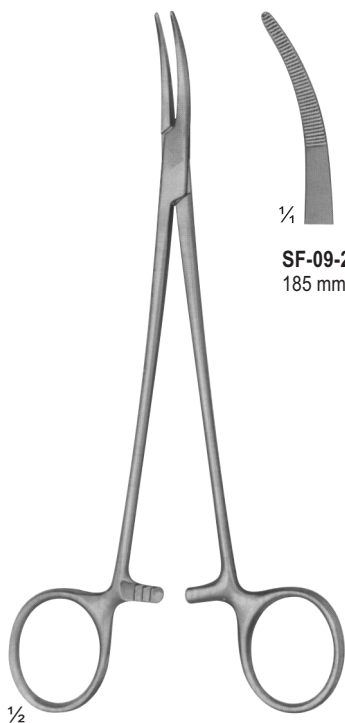

SF-09-248
NISSEN

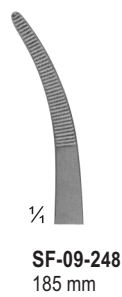

SF-09-248
185 mm

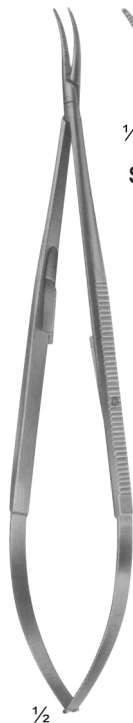

SF-09-249 - SF-09-250
YASARGIL
195 mm

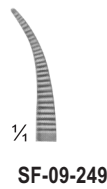

SF-09-249

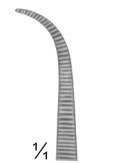

SF-09-250



SF-09-251
OVERHOLT-MIXTER

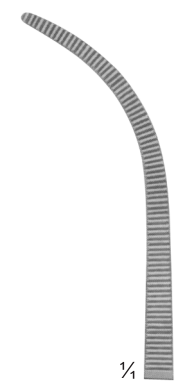

SF-09-251
205 mm



1/2

CRAFOORD
SF-09-252 - SF-09-253

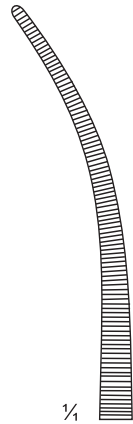

1/4

SF-09-252
180 mm

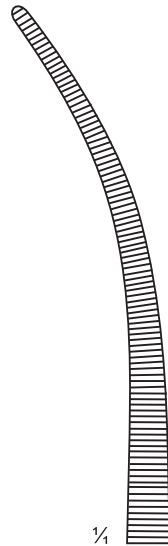

1/4

SF-09-253
240 mm

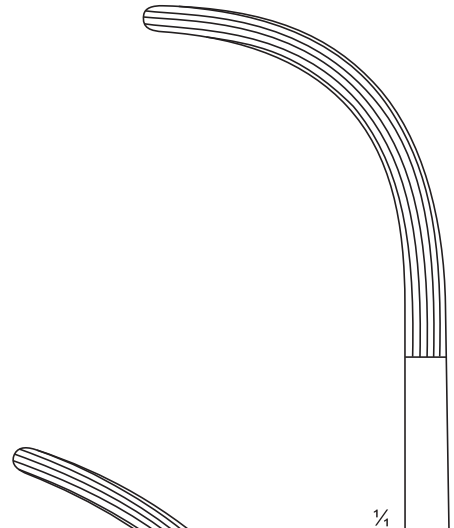

1/4

SF-09-256

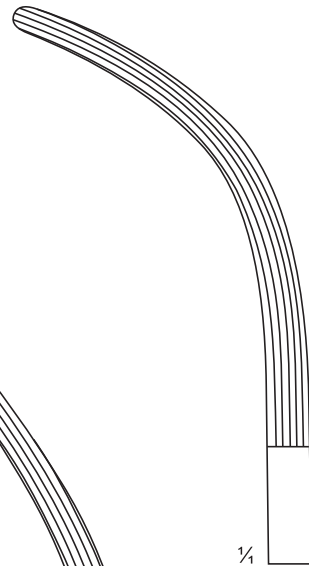

1/4

SF-09-255

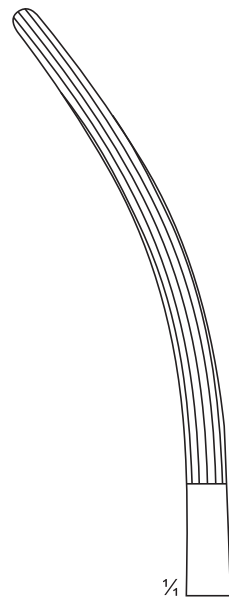

1/4

SF-09-254



1/4

CRAFOORD-SELLORS
SF-09-254 - SF-09-256
240 mm

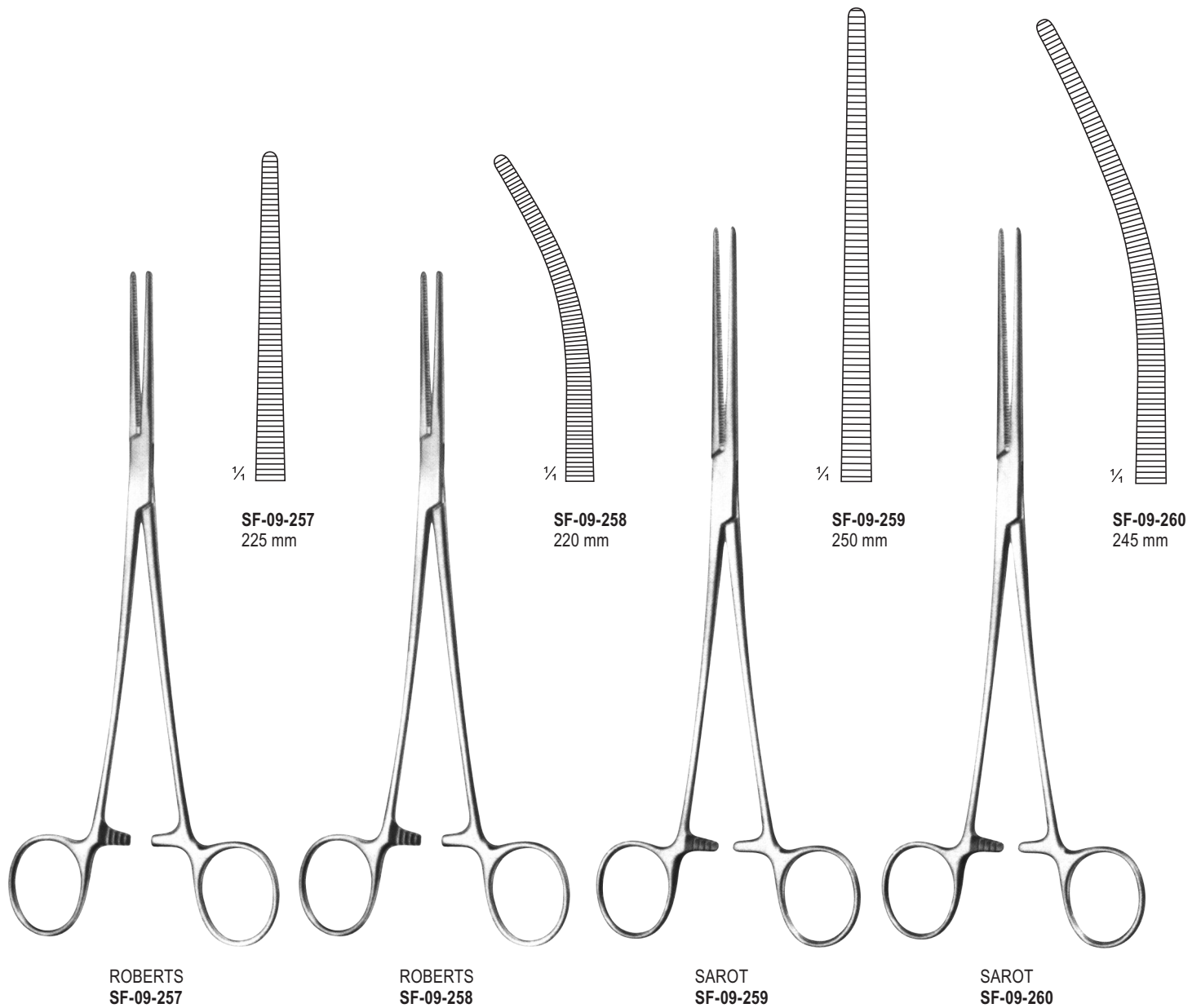



1/4

SF-09-261

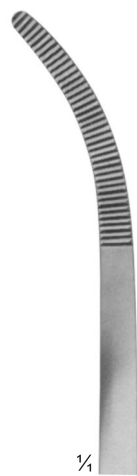

1/4

SF-09-262



1/4

SF-09-263

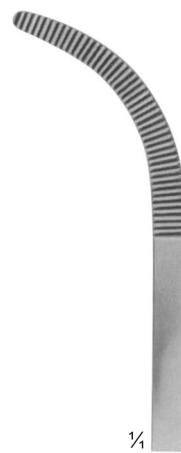

1/4

SF-09-264



1/4

SF-09-265

RUMEL
SF-09-261 - SF-09-265
240 mm

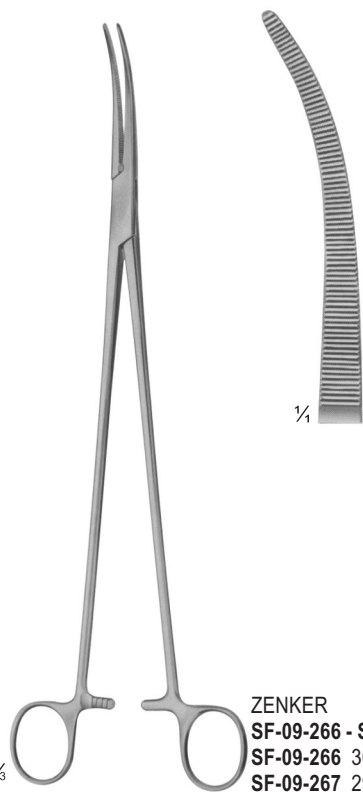

ZENKER
SF-09-266 - SF-09-267
SF-09-266 300 mm
SF-09-267 290 mm

1/3



1/4

LAWRENCE
SF-09-268
270 mm

1/3

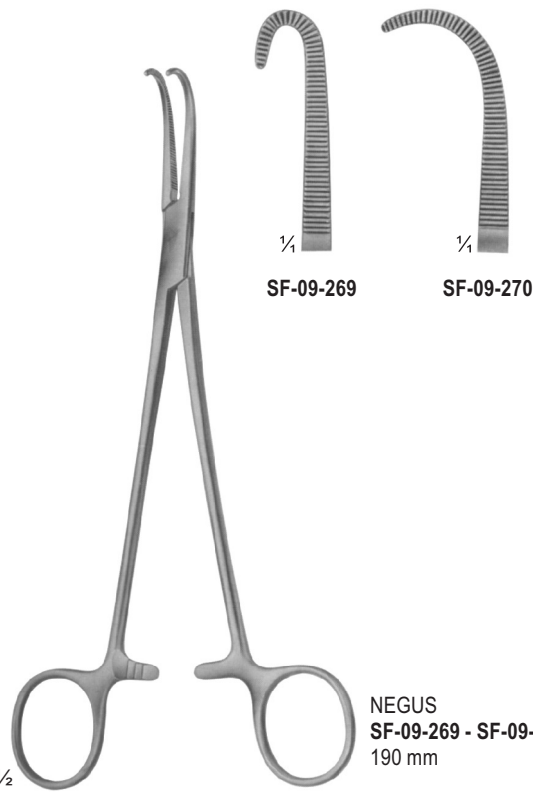

1/4

SF-09-269

1/4

SF-09-270

NEGUS
SF-09-269 - SF-09-270
190 mm

1/2

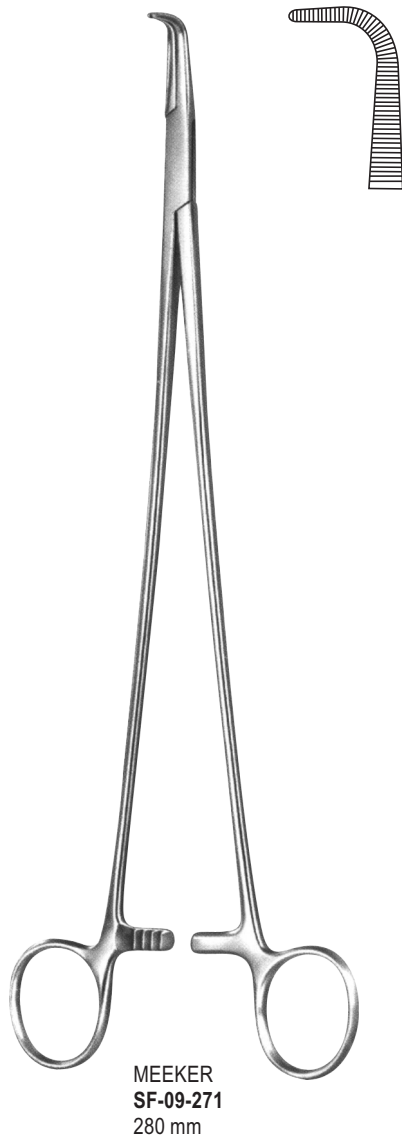

Fig. 1
SF-09-272
190 mm



Fig. 1
SF-09-273
225 mm



Fig. 1
SF-09-274
240 mm



Fig. 2
SF-09-275
190 mm



Fig. 2
SF-09-276
220 mm

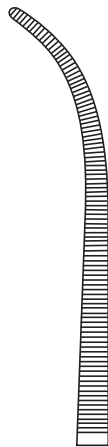

Fig. 2
SF-09-277
235 mm



Fig. 3
SF-09-278
185 mm



Fig. 3
SF-09-279
215 mm



Fig. 3
SF-09-280
235 mm



SF-09-281 - SF-09-292
OVERHOLT-GEISSENDOERFER

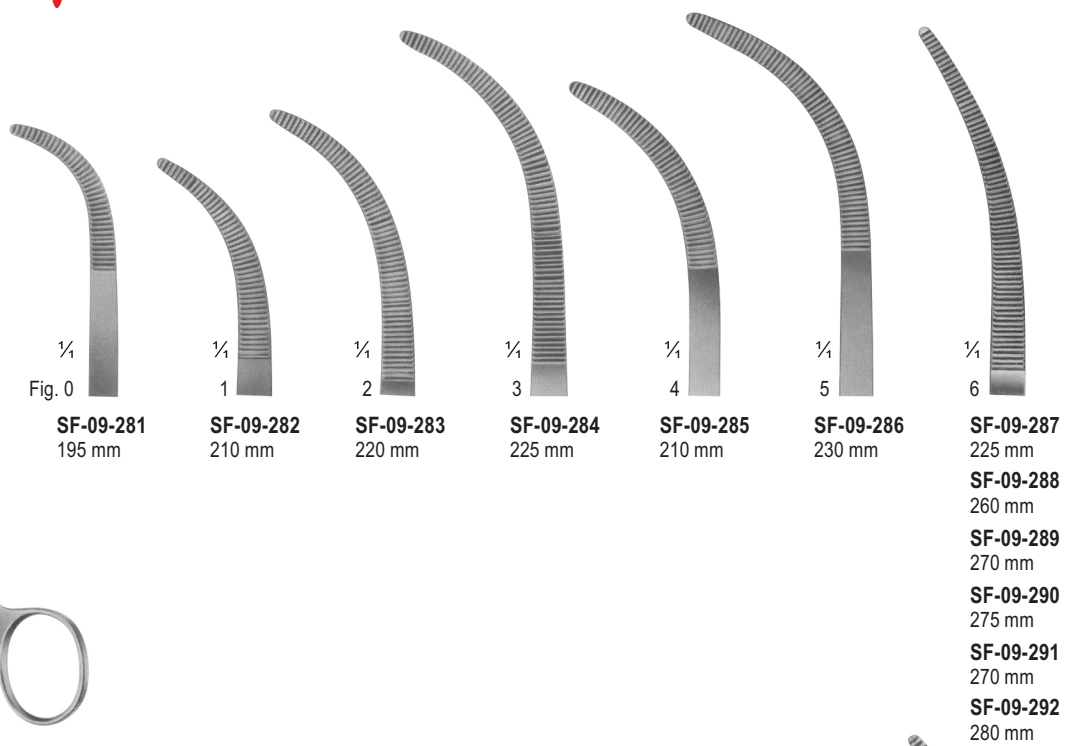

1/4
Fig. 0

SF-09-281
195 mm

1/4
1

SF-09-282
210 mm

1/4
2

SF-09-283
220 mm

1/4
3

SF-09-284
225 mm

1/4
4

SF-09-285
210 mm

1/4
5

SF-09-286
230 mm

1/4
6

SF-09-287
225 mm

SF-09-288
260 mm

SF-09-289
270 mm

SF-09-290
275 mm

SF-09-291
270 mm

SF-09-292
280 mm

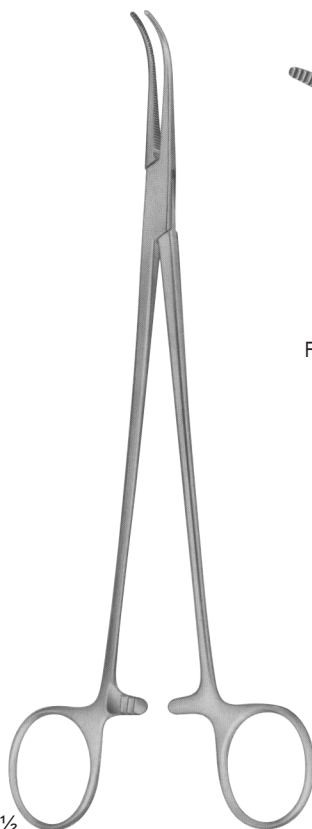

SF-09-293 - SF-09-300
OVERHOLT
fine pattern

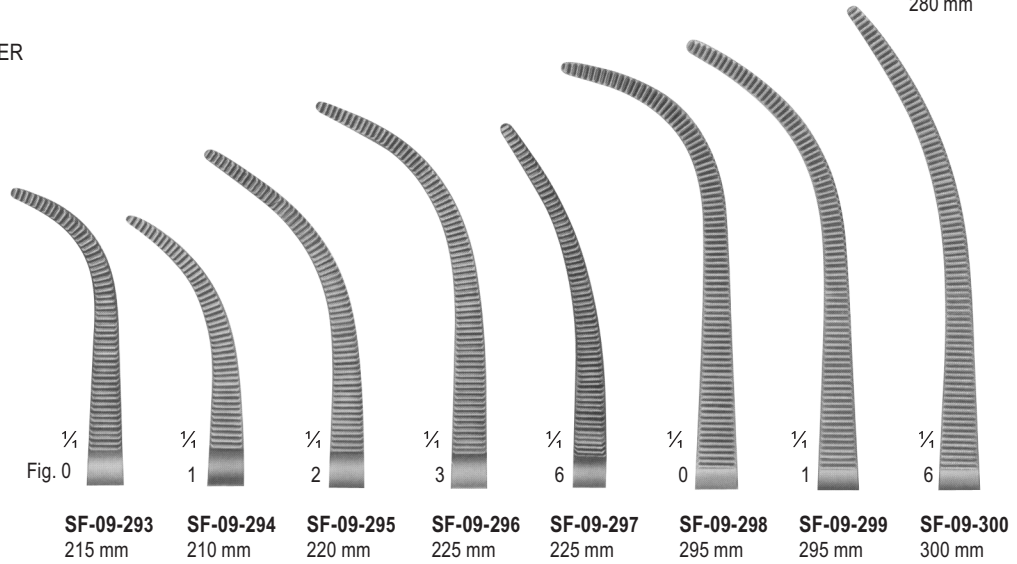

1/4
Fig. 0

SF-09-293
215 mm

1/4
1

SF-09-294
210 mm

1/4
2

SF-09-295
220 mm

1/4
3

SF-09-296
225 mm

1/4
6

SF-09-297
225 mm

1/4
0

SF-09-298
295 mm

1/4
1

SF-09-299
295 mm

1/4
6

SF-09-300
300 mm

HAEMOSTATIC FORCEPS

www.surgiforce.com



MINI-GEMINI
SF-09-301 - SF-09-304

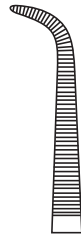

SF-09-301
180 mm

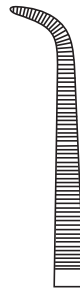

SF-09-302
230 mm



SF-09-303
250 mm



SF-09-304
280 mm

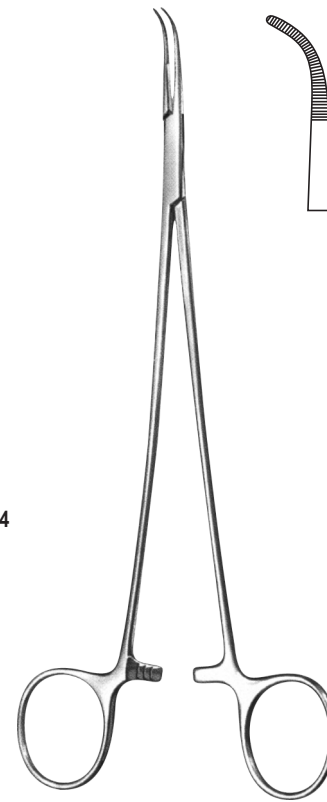

OVERHOLT-MINI
SF-09-305
200 mm



GEMINI
SF-09-306 - SF-09-312



SF-09-306
130 mm



SF-09-307
160 mm



SF-09-308
180 mm



SF-09-309
210 mm



SF-09-310
230 mm



SF-09-311
250 mm

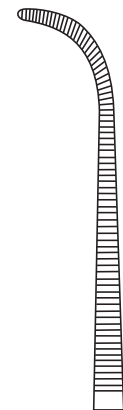

SF-09-312
280 mm



SF-09-313
MIXTER-O'SHAUGHNESSY
190 mm

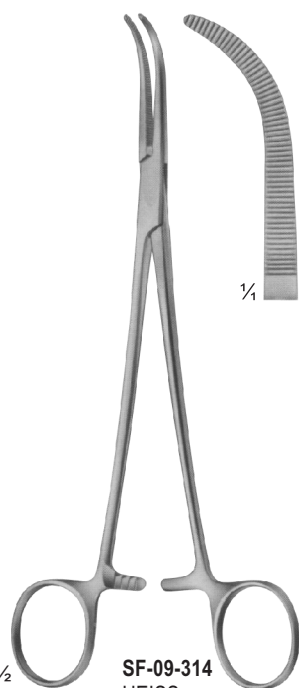

SF-09-314
HEISS
195 mm

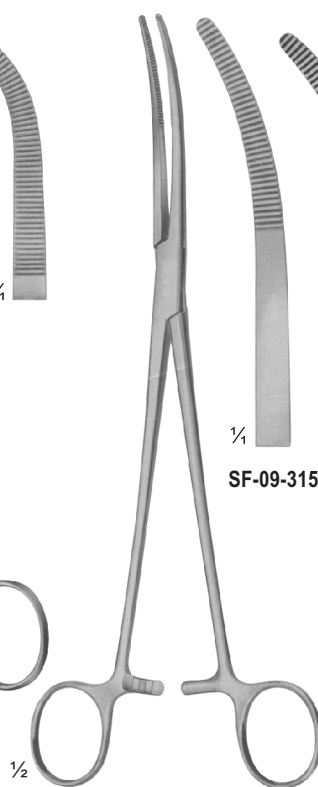

SF-09-315 - SF-09-319
RUMEL
240 mm

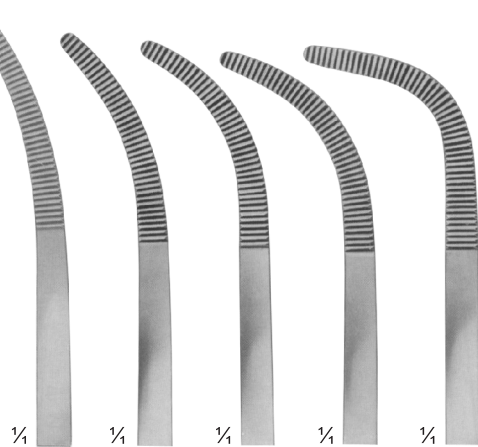

SF-09-315 SF-09-316 SF-09-317 SF-09-318 SF-09-319

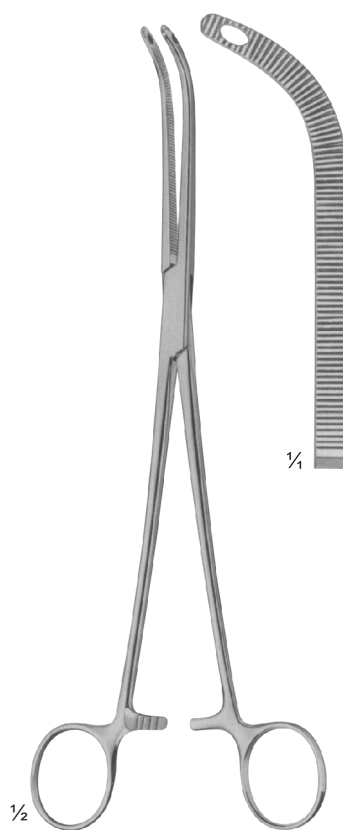

SF-09-320
FINOCHIETTO
245 mm

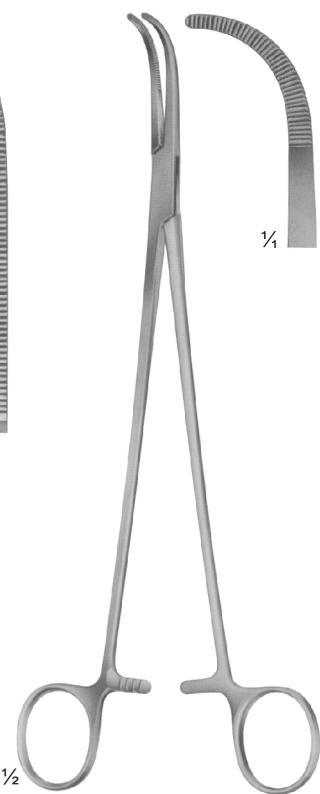

SF-09-321
MIXTER
230 mm

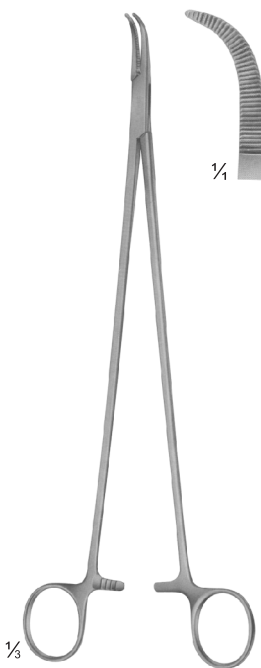

SF-09-322
LAWRENCE
270 mm

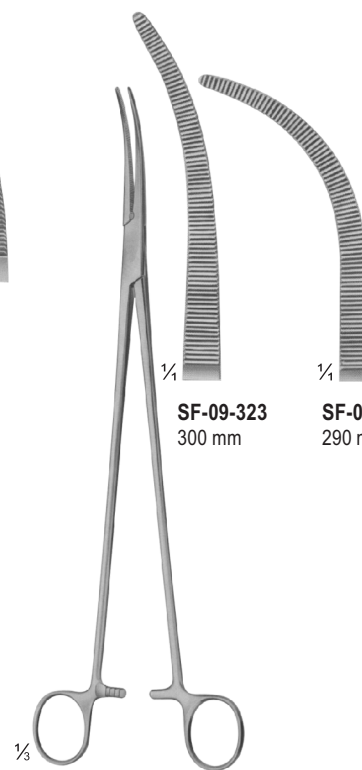

SF-09-323 - SF-09-324
ZENKER

SF-09-323
300 mm

SF-09-324
290 mm

DISSECTING- AND LIGATURE FORCEPS

www.surgiforce.com

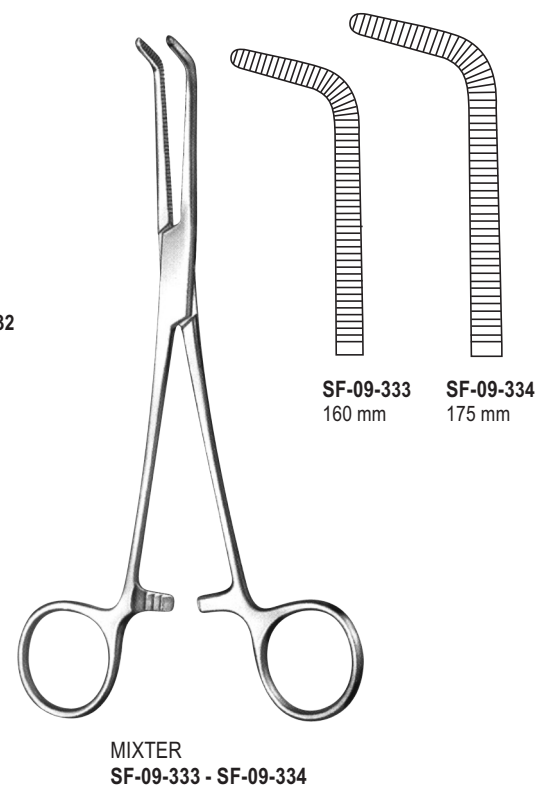
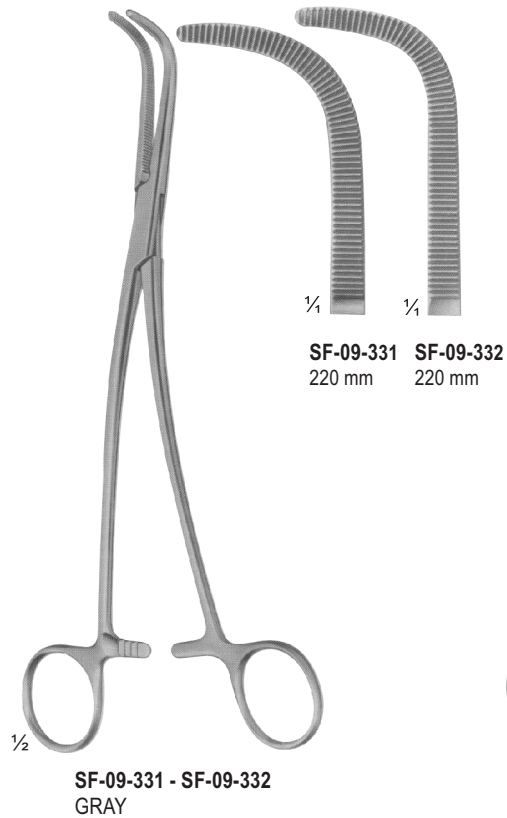
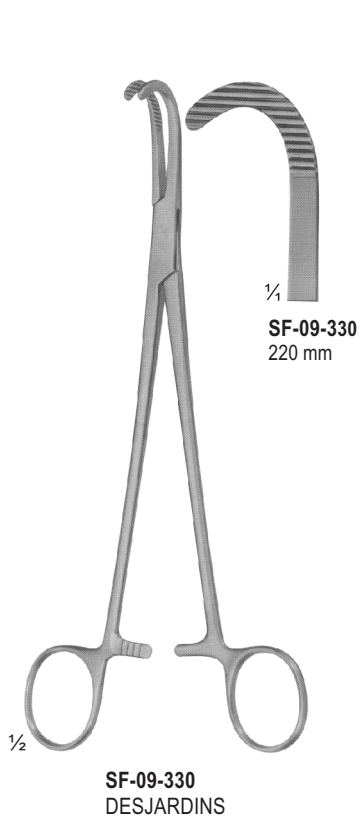
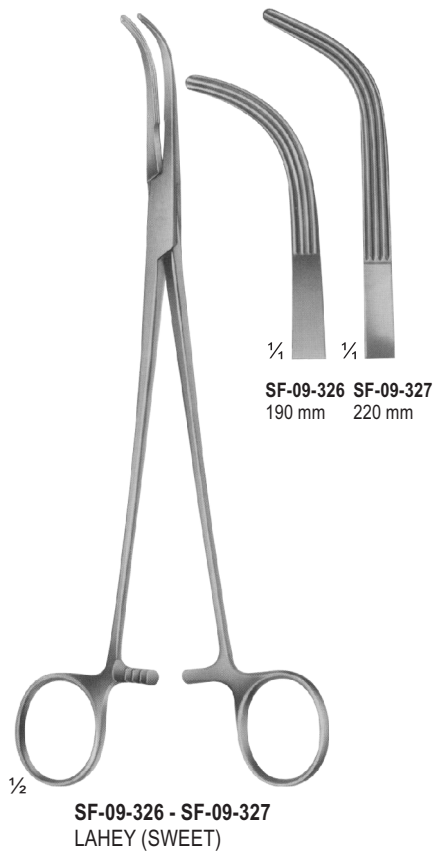

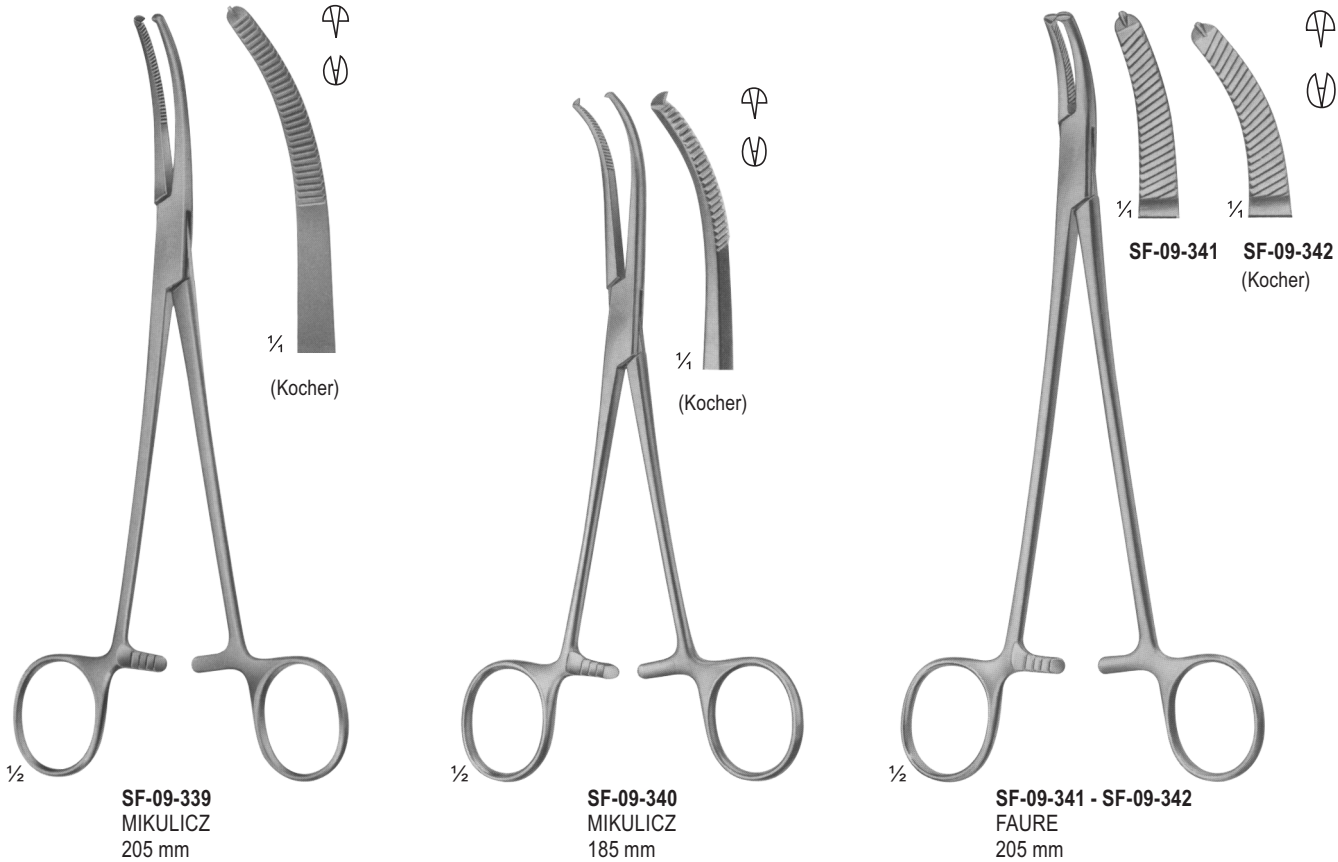
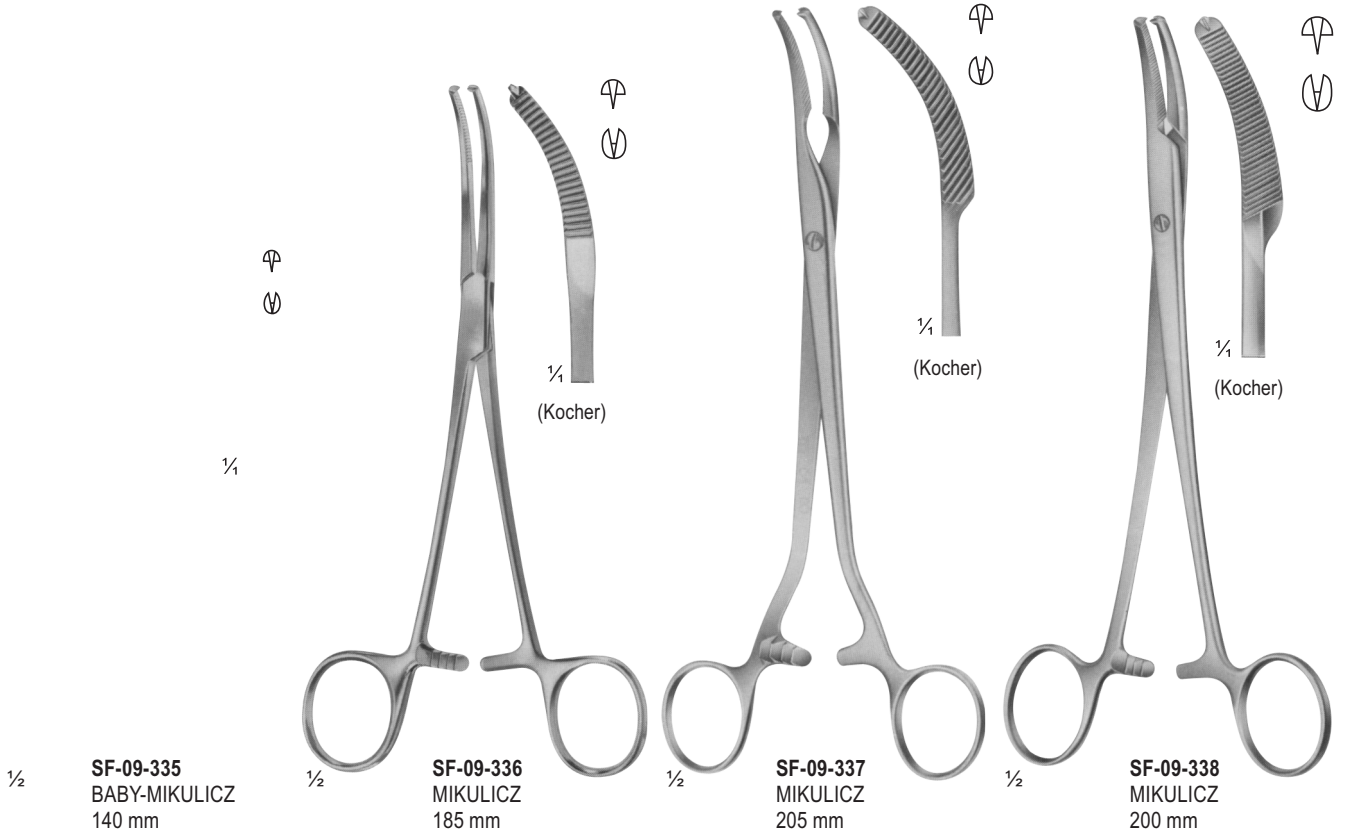

HYSTERECTOMY FORCEPS

www.surgiforce.com

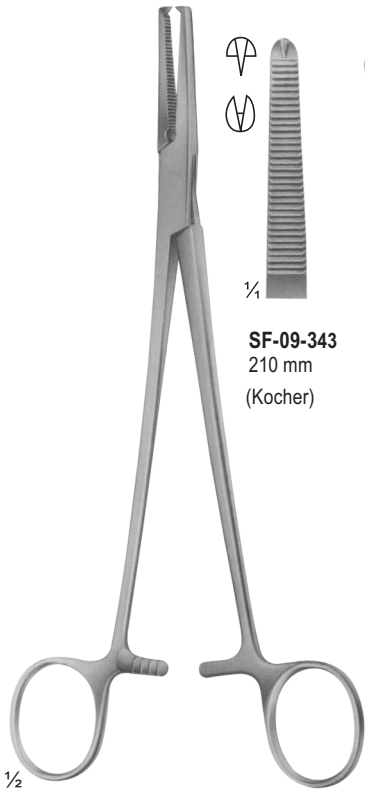

SF-09-343
210 mm
(Kocher)

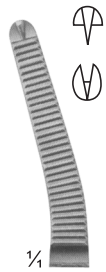

SF-09-344
205 mm
(Kocher)

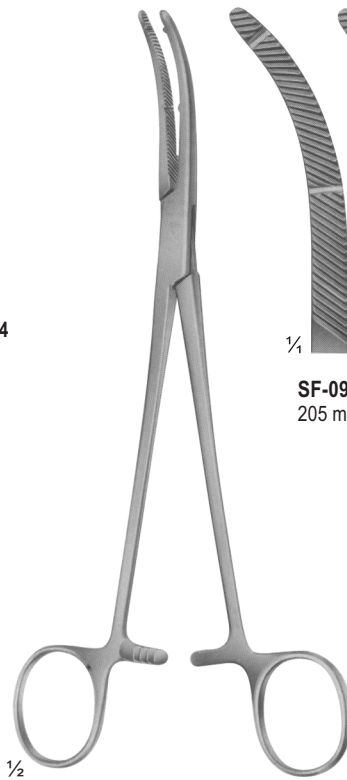

SF-09-345 **SF-09-346**
205 mm 245 mm

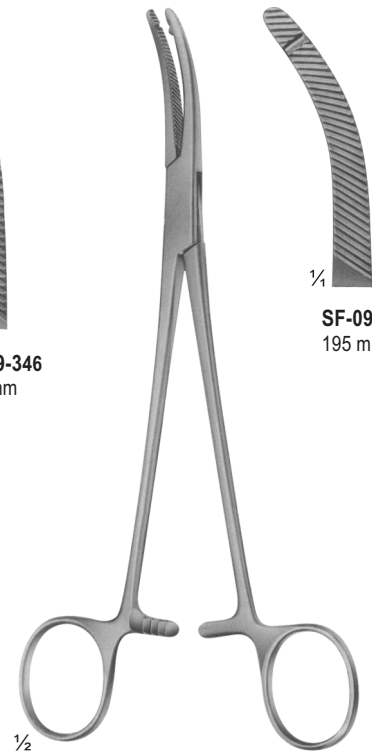

SF-09-347
195 mm

SF-09-343 - SF-09-344
PHANEUF

SF-09-345 - SF-09-346
HEANEY modif.

SF-09-347
HEANEY

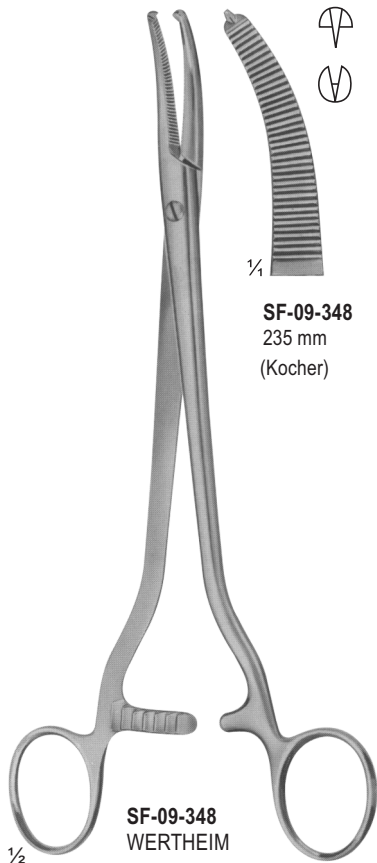

SF-09-348
235 mm
(Kocher)

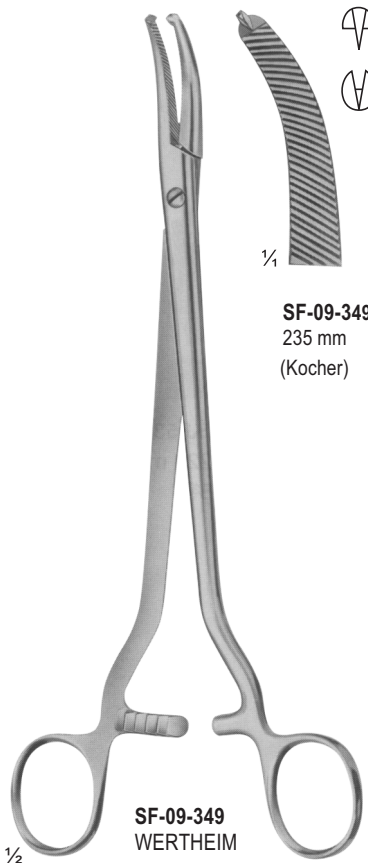

SF-09-349
235 mm
(Kocher)

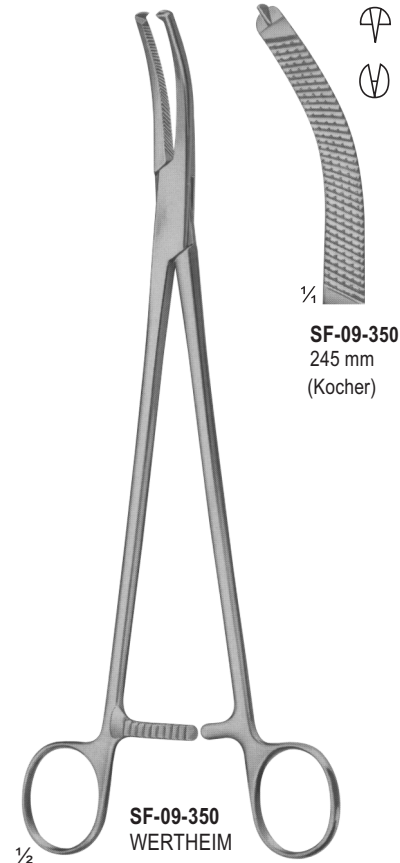

SF-09-350
245 mm
(Kocher)

SF-09-348
WERTHEIM

SF-09-349
WERTHEIM

SF-09-350
WERTHEIM

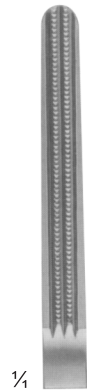

SF-09-351
225 mm

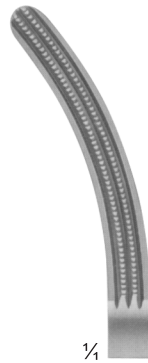

SF-09-352
220 mm



SF-09-353
215 mm

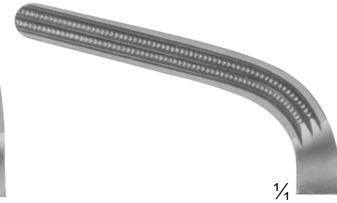

SF-09-354
205 mm

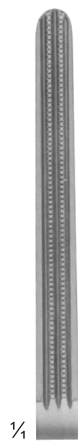

SF-09-355
250 mm

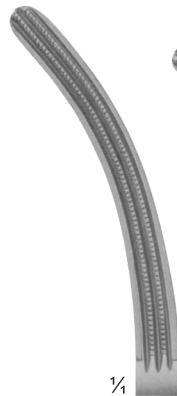

SF-09-356
245 mm



SF-09-357
240 mm

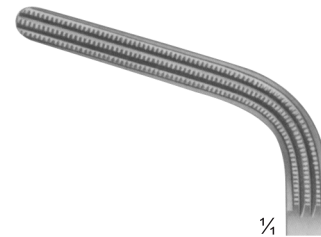

SF-09-358
220 mm

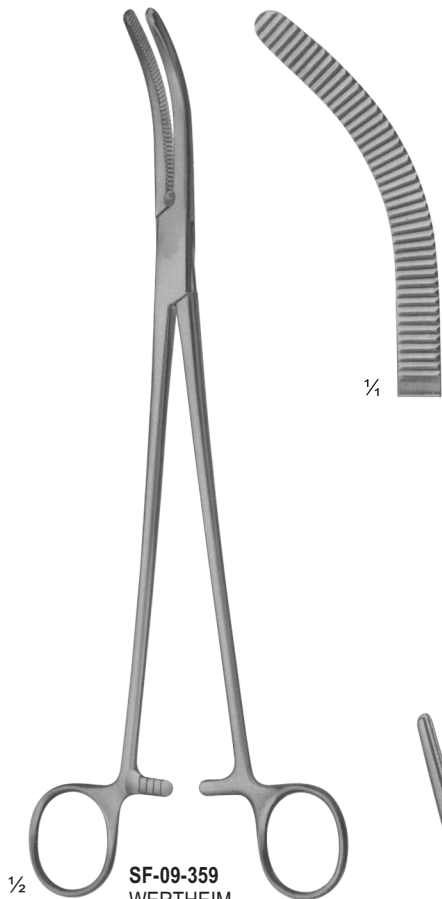

$\frac{1}{2}$ **SF-09-359**
WERTHEIM
Hysterectomy Forceps
255 mm

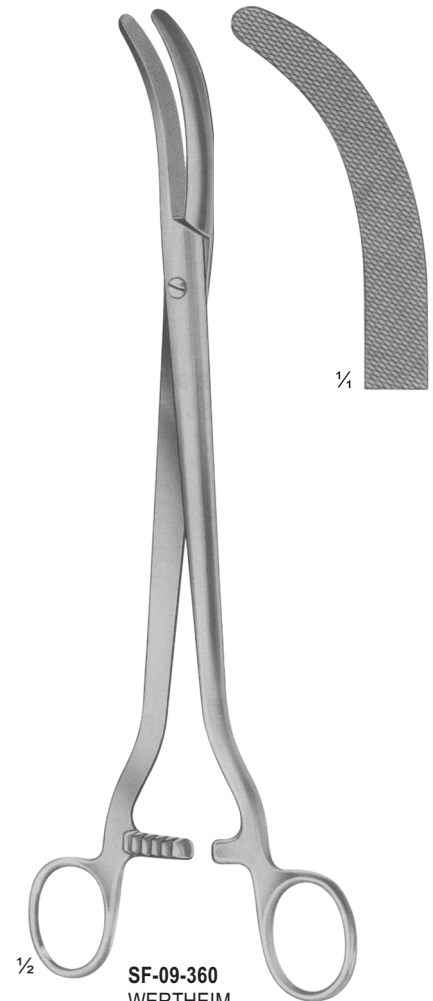

$\frac{1}{2}$ **SF-09-360**
WERTHEIM
Parametrium Clamp
260 mm

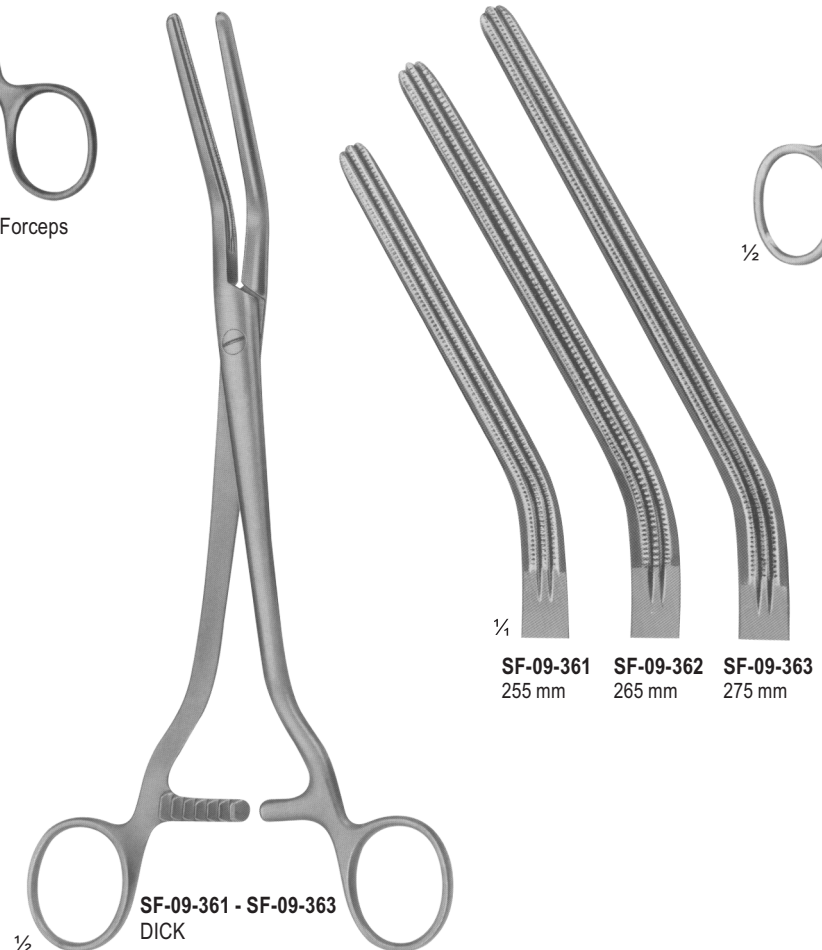

$\frac{1}{2}$ **SF-09-361 - SF-09-363**
DICK

$\frac{1}{4}$ **SF-09-361** 255 mm **SF-09-362** 265 mm **SF-09-363** 275 mm

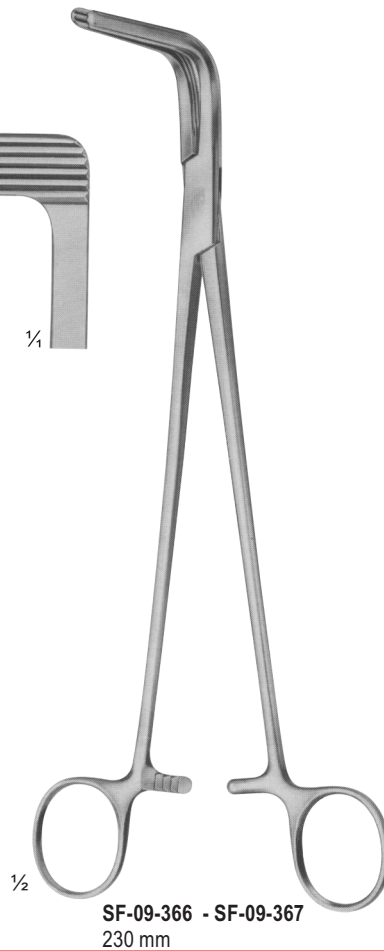
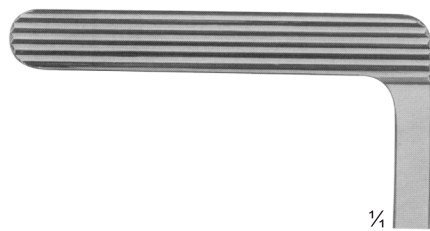
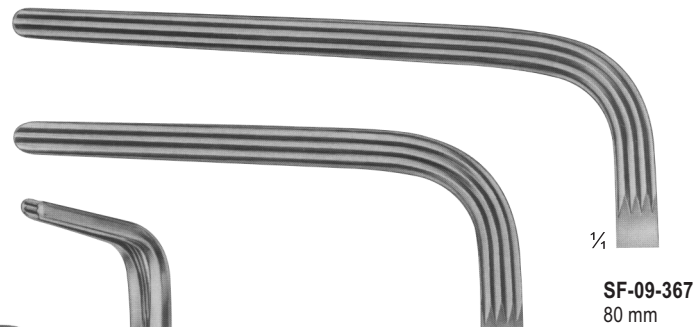
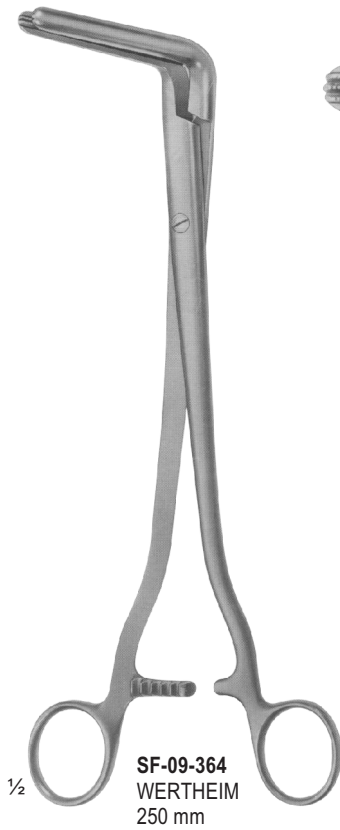

DELICATE HAEMOSTATIC FORCEPS

www.surgiforce.com

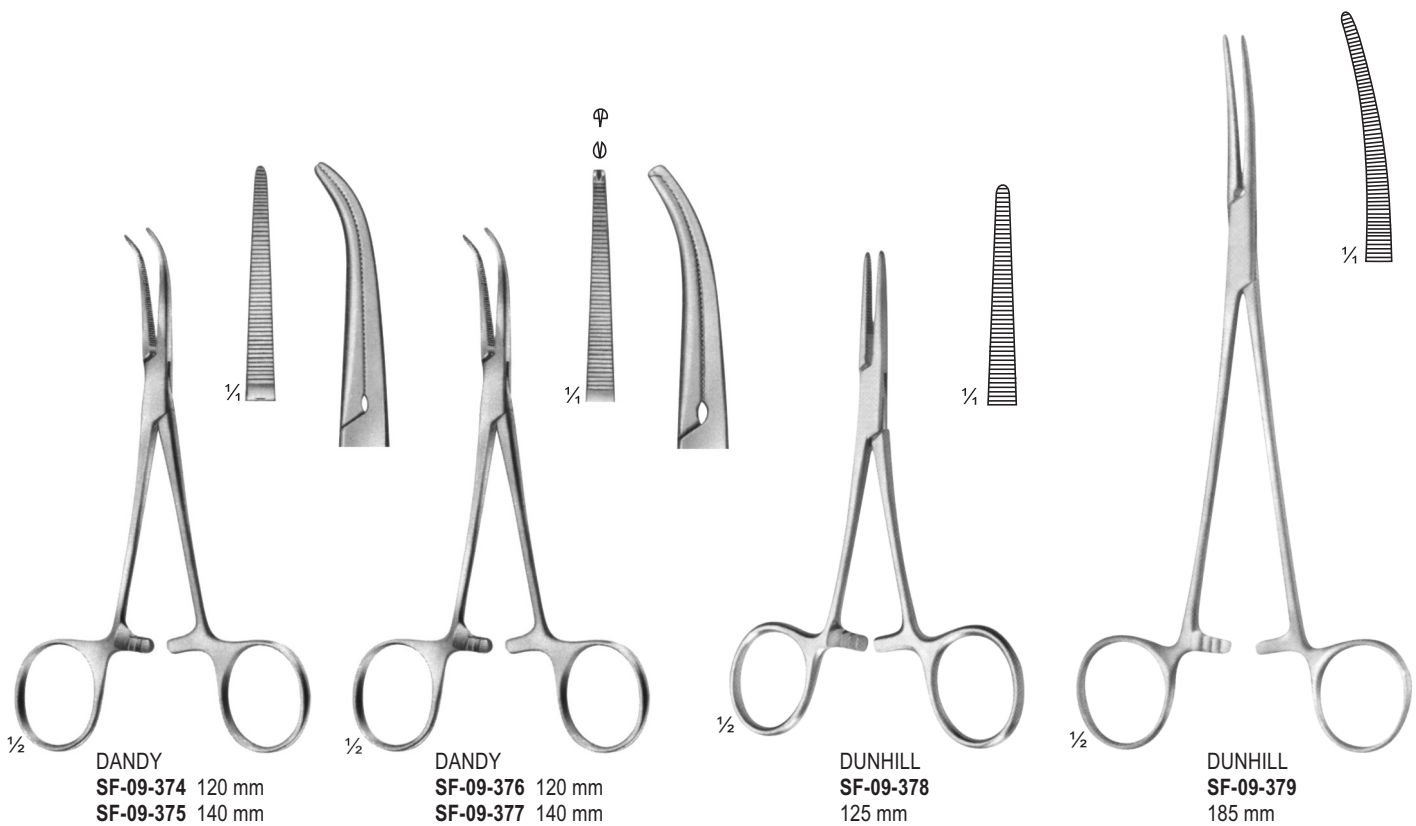
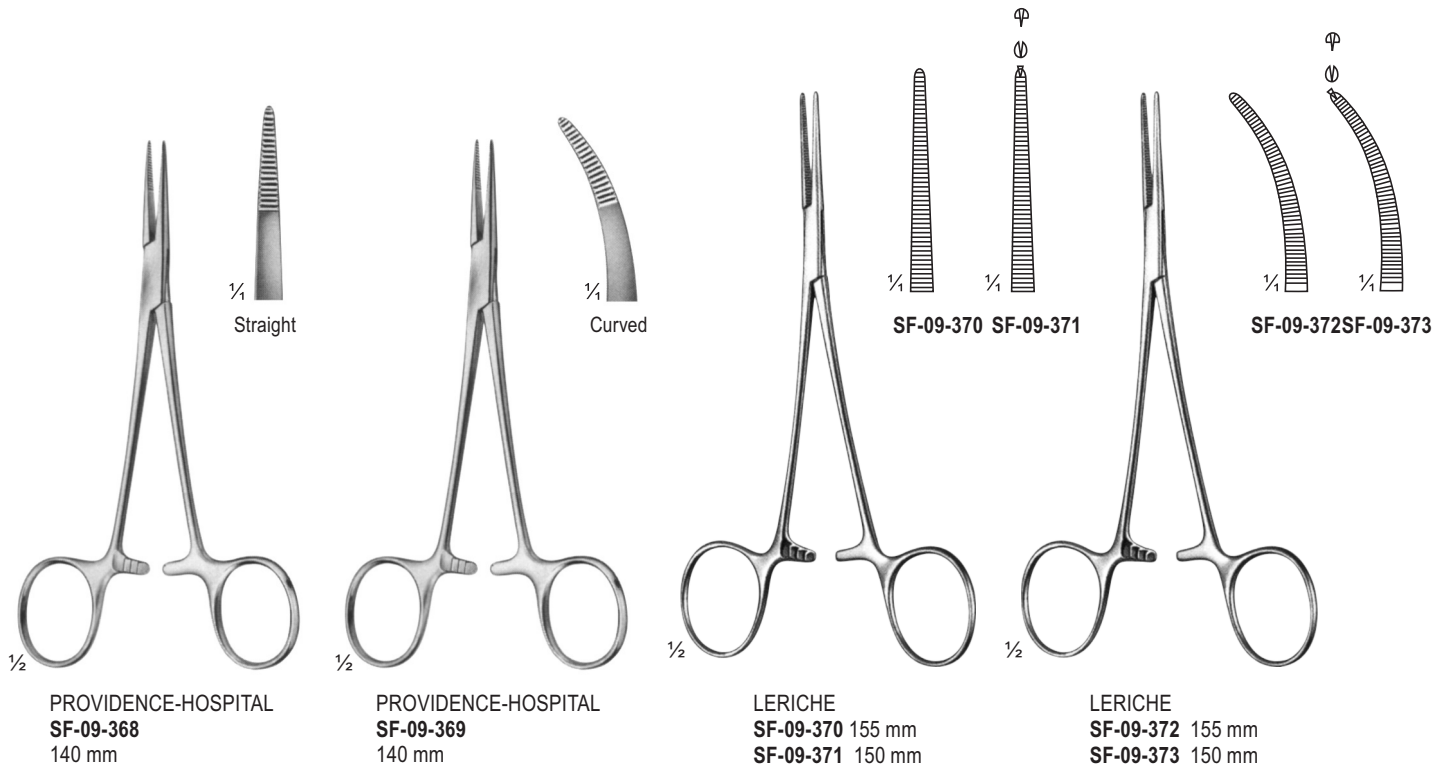

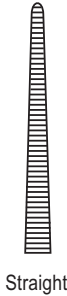
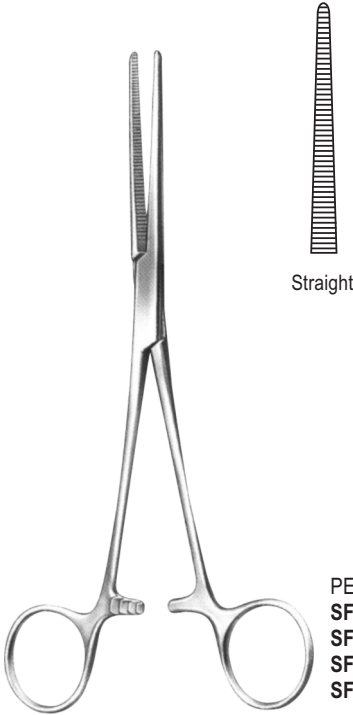

Straight

PEAN
SF-09-380 - SF-09-382
SF-09-380 130 mm
SF-09-381 140 mm
SF-09-382 170 mm

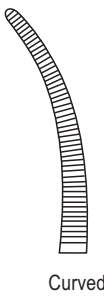
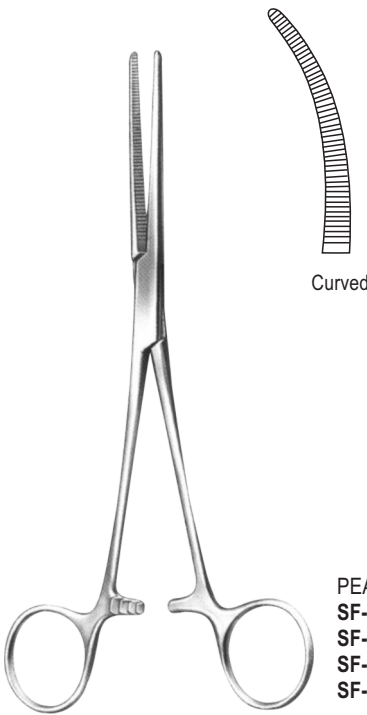

Curved

PEAN
SF-09-383 - SF-09-385
SF-09-383 130 mm
SF-09-384 140 mm
SF-09-385 170 mm

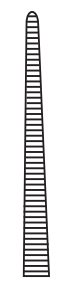
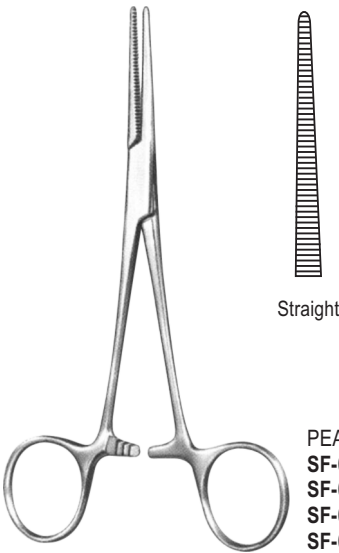

Straight

PEAN-Delicate
SF-09-386 - SF-09-388
SF-09-386 140 mm
SF-09-387 160 mm
SF-09-388 180 mm

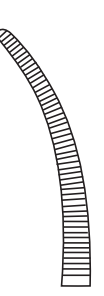
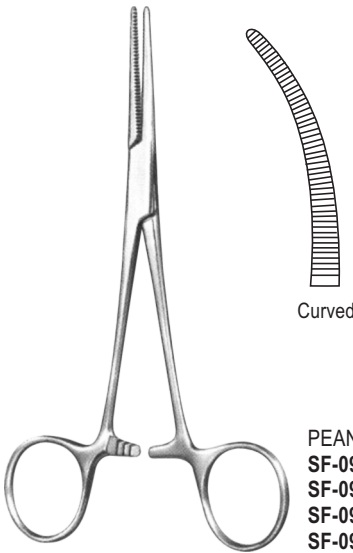

Curved

PEAN-Delicate
SF-09-389 - SF-09-391
SF-09-389 140 mm
SF-09-390 160 mm
SF-09-391 180 mm

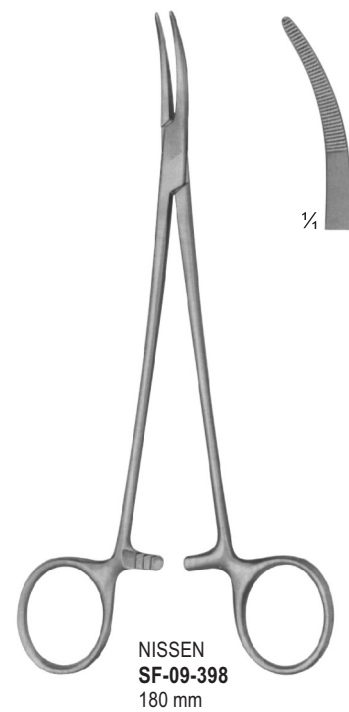
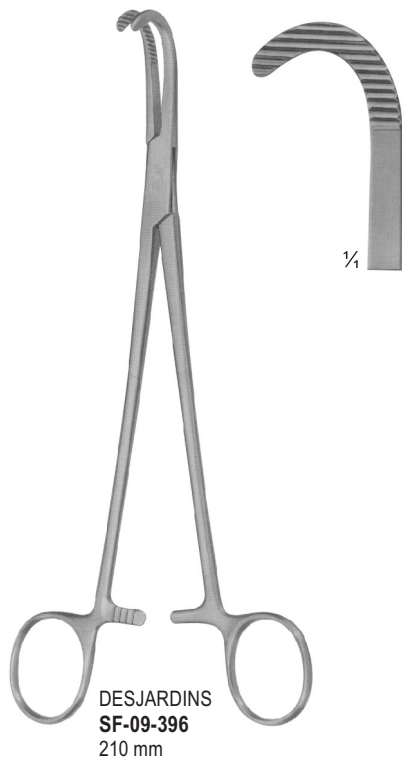
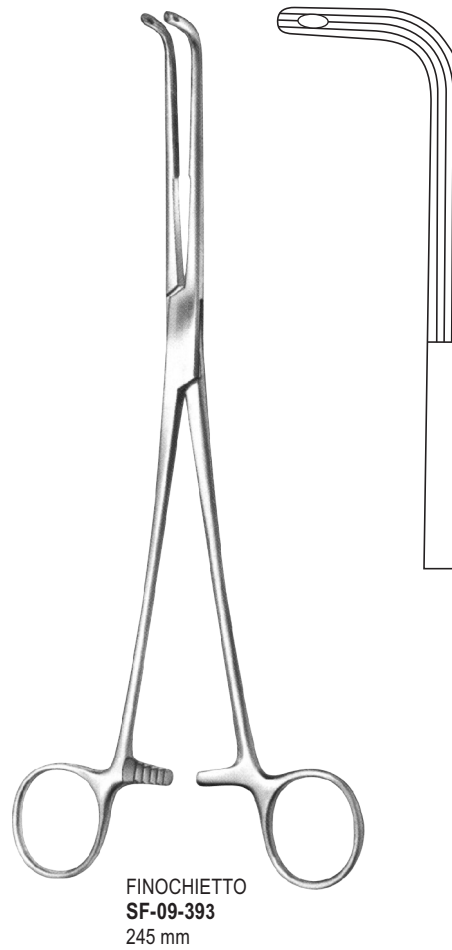
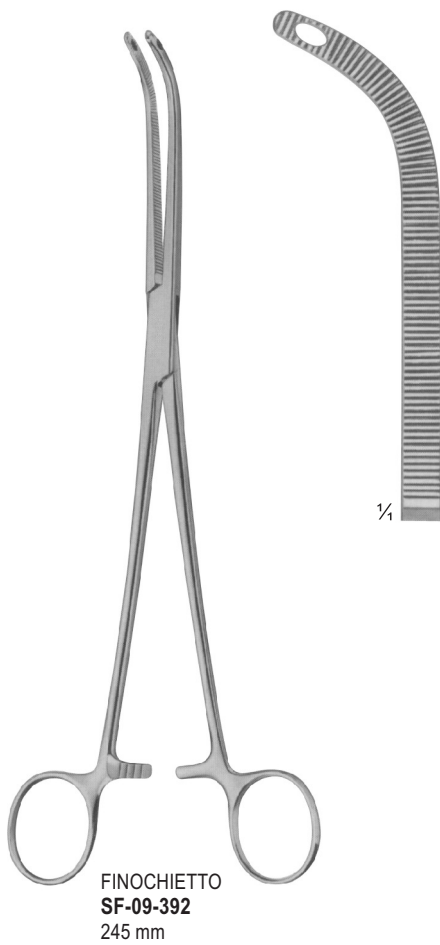



1/4

SF-09-399

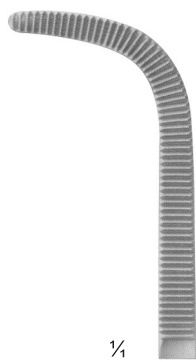

1/4

SF-09-400



GRAY
SF-09-401 - SF-09-402
220 mm

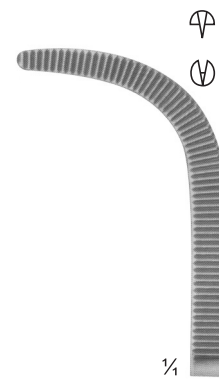

1/4

SF-09-401

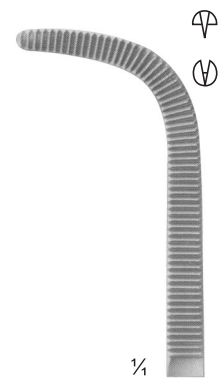

1/4

SF-09-402

GRAY
SF-09-399 - SF-09-300
220 mm



NEGUS
SF-09-403 - SF-09-404
190 mm



1/4

SF-09-403



1/4

SF-09-404



MOYNIHAN
SF-09-405 - SF-09-406



1/4

SF-09-405
230 mm



1/4

SF-09-406
240 mm

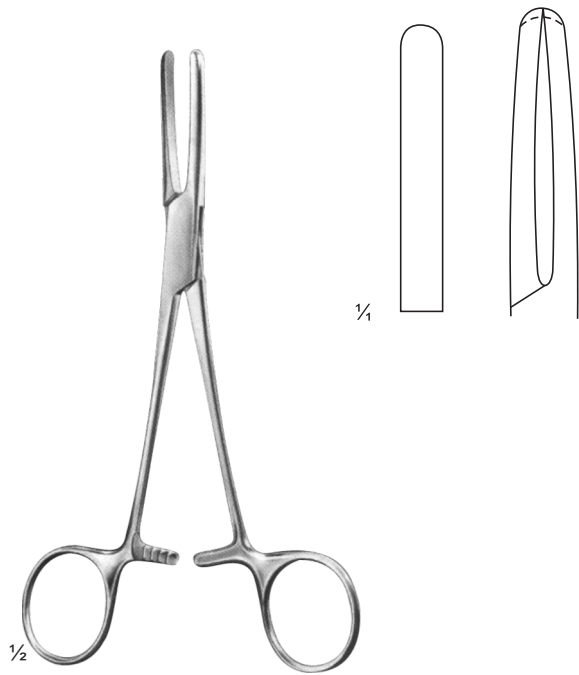

SF-09-407
16.5 cm

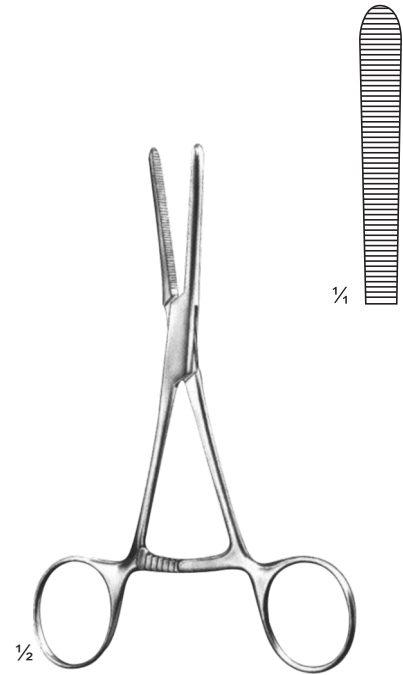

SF-09-408
14 cm



SF-09-409 - SF-09-410

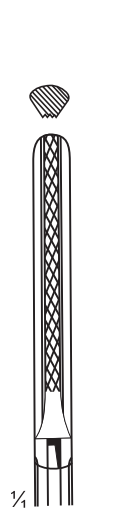

SF-09-409
190 mm



SF-09-410
205 mm

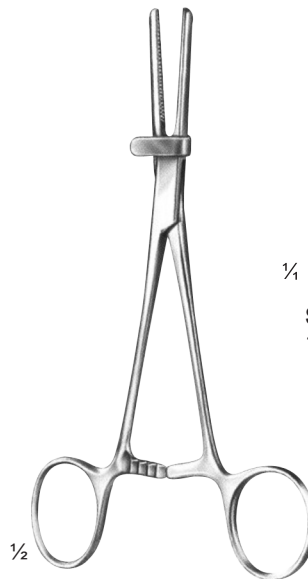

SF-09-411 - SF-09-413



SF-09-411
155 mm



SF-09-412
190 mm

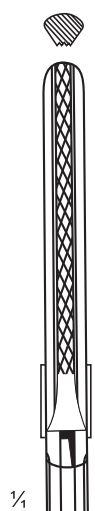

SF-09-413
205 mm

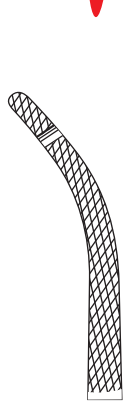

Fig. 1
SF-09-414
195 mm

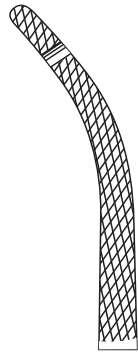

Fig. 1
SF-09-415
215 mm

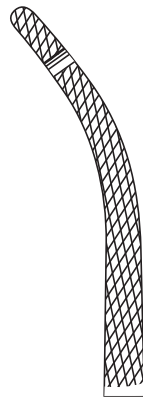

Fig. 1
SF-09-416
240 mm



Fig. 2
SF-09-417
195 mm

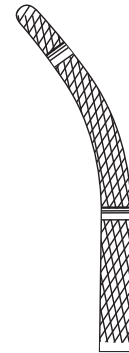

Fig. 2
SF-09-418
215 mm

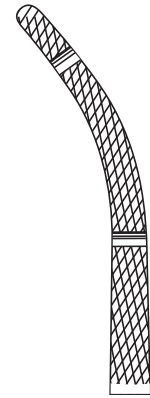
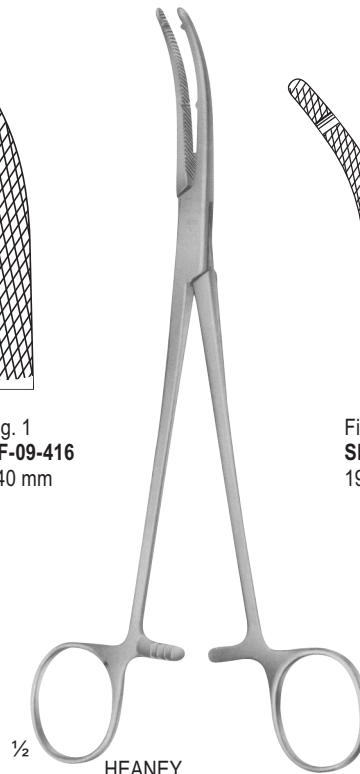
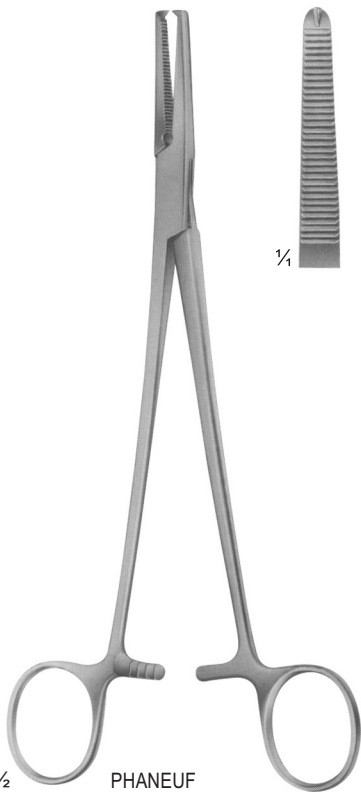

Fig. 2
SF-09-419
240 mm



1/2
HEANEY
SF-09-417 - SF-09-419

1/2
HEANEY
SF-09-414 - SF-09-416



1/2
PHANEUF
SF-09-420 210 mm
SF-09-421 200 mm

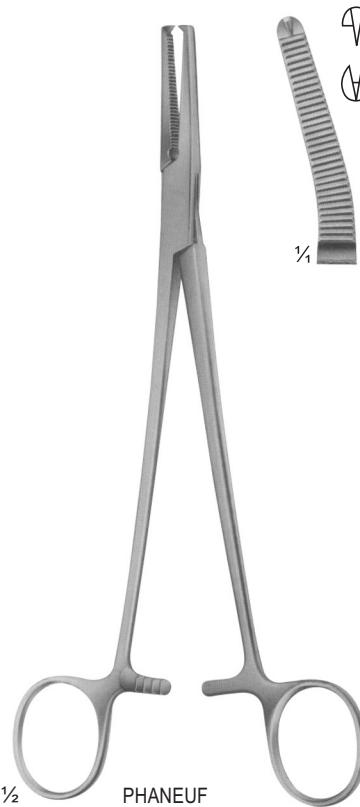

1/2
PHANEUF
SF-09-422 210 mm
SF-09-423 200 mm

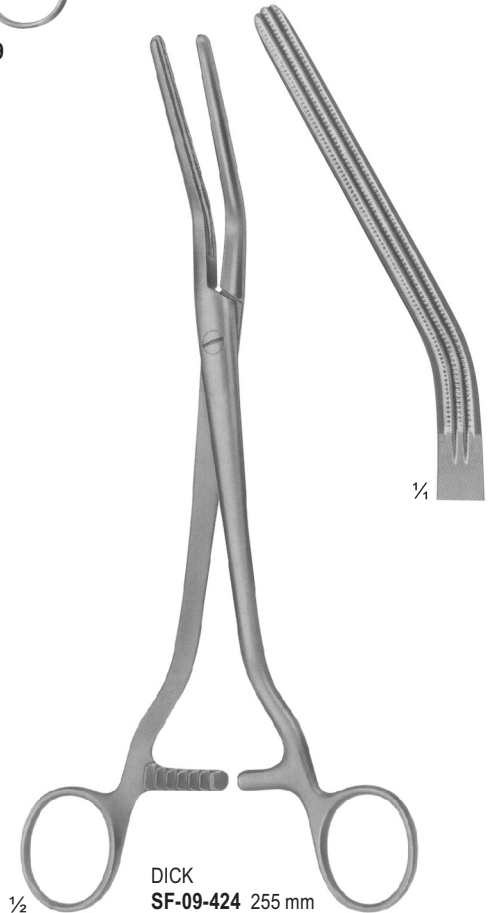

1/2
DICK
SF-09-424 255 mm
SF-09-425 265 mm
SF-09-426 275 mm



Surgiforce Instruments



Opposite Surgical Association,
Malkay Kalan, Marala Road,
Sialkot-51050 Pakistan.



+92 523 559131



info@surgiforce.com
sales@surgiforce.com



www.surgiforce.com



Our Certifications:

ISO 9001

CE Certified

EN 13485:2012

ISO 7153-1

ISO 7151

ISO 17664:2004

ISO 13402

ISO 15223



No.3012922148