

Page
243–253

- Vaginal Specula

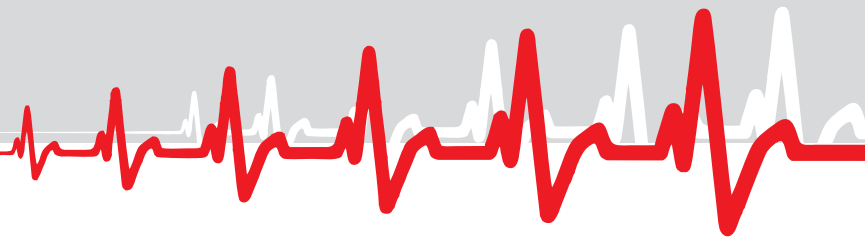

1/2

SF-13-101
COLLIN
for children
53 x 10 mm

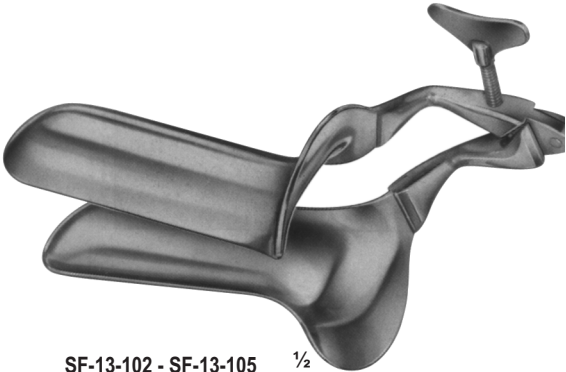

SF-13-102 - SF-13-105 1/2
COLLIN

SF-13-102	100/90mm	28 mm
SF-13-103	100/90mm	32 mm
SF-13-104	105/95mm	35 mm
SF-13-105	115/105mm	40 mm

Total length/working length width

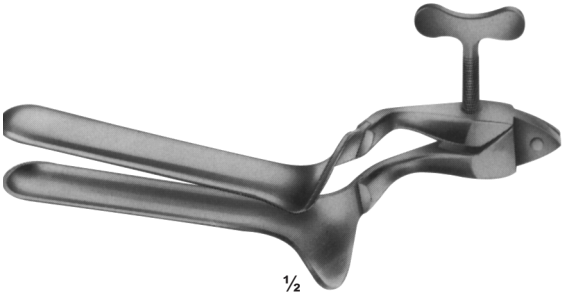

1/2

SF-13-106
COLLIN
for virgins
95/85 x 18 mm

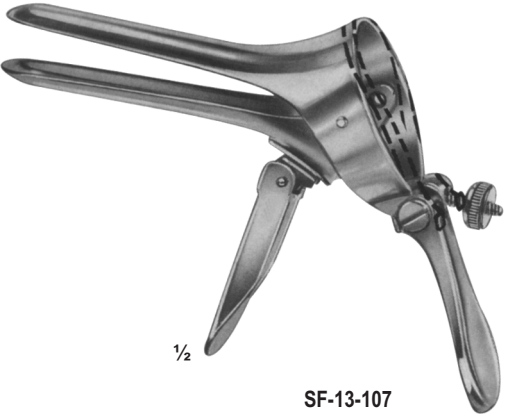

1/2

SF-13-107
CUSCO
for virgins
75 x17 mm

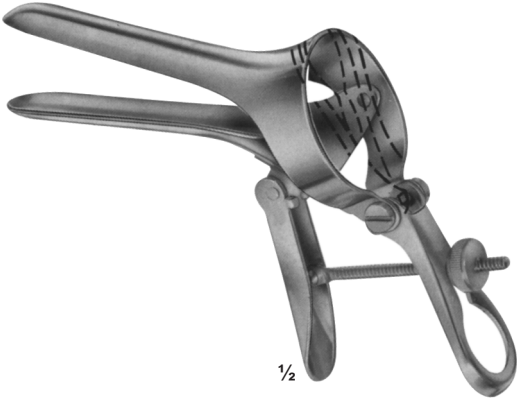

1/2

SF-13-108
CUSCO
for virgins
75 x17 mm

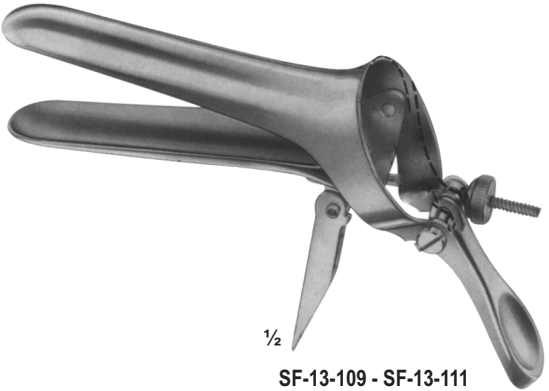

1/2

SF-13-109 - SF-13-111
CUSCO

MN-009	92x23-25 mm
MN-010	100x25-27 mm
MN-011	110x27-30 mm



SF-13-112 - SF-13-115
CUSCO
STANDARD
SF-13-112 80X24 mm
SF-13-113 80X32 mm
SF-13-114 90X36 mm
SF-13-115 110X37 mm



SF-13-116 - SF-13-119
CUSCO
SF-13-116 80X24 mm
SF-13-117 80X32 mm
SF-13-118 90X36 mm
SF-13-119 110X37 mm



SF-13-120 - SF-13-122
CUSCO
SF-13-120 80X24 mm
SF-13-121 80X32 mm
SF-13-122 115X36 mm



SF-13-123 - SF-13-124
SEYFFERT
SF-13-123 100X24 mm
SF-13-124 110X32 mm
230 mm



SF-13-125
SEMM
for children
and virgins
180 mm

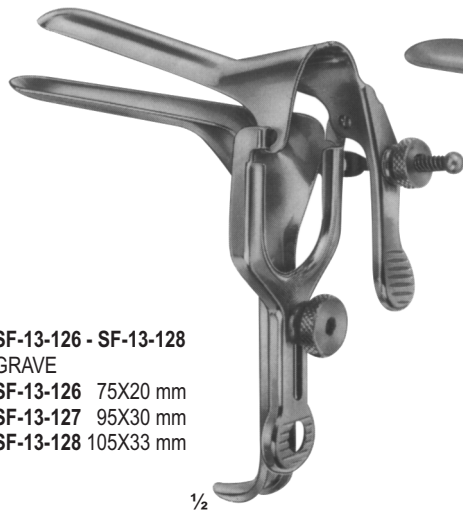

SF-13-126 - SF-13-128
GRAVE
SF-13-126 75X20 mm
SF-13-127 95X30 mm
SF-13-128 105X33 mm

1/2



SF-13-129 - SF-13-130
SF-13-129 100X22 mm
SF-13-130 120X25 mm

1/2



SF-13-131 - SF-13-132
BRIESKY
SF-13-131 72X25 mm / 77X30 mm
SF-13-132 75X30 mm / 92X38 mm
170 mm

1/2



1/2

SF-13-133 - SF-13-134
BREISKY
SF-13-133 100X22 mm
77 X30 mm
140 mm
SF-13-134 120X25 mm
92 X38 mm
170 mm



1/2

SF-13-135 - SF-13-137
SEIDL
SF-13-135 80X8 mm
SF-13-136 80X10 mm
SF-13-137 90X14 mm
For children and infants
170 mm



1/2

SF-13-138
KRISTELLER
70X15 mm, (170 mm)
For children



1/2

SF-13-139 - SF-13-141
SIMS
SF-13-139 70X26 mm
75 X30 mm 125 mm
SF-13-140 75X30 mm
80 X85 mm 150 mm
SF-13-141 80X36 mm
90 X40 mm 175 mm



SF-13-147 75X10 mm
175 mm

SF-13-151 70X15 mm
175 mm

SF-13-148 75X23 mm
180 mm

SF-13-152 70X27 mm
180 mm

SF-13-149 80X25 mm
180 mm

SF-13-153 75X30 mm
180 mm

SF-13-150 100X32 mm
185 mm

SF-13-154 90X36 mm
185 mm

SF-13-142 - SF-13-146
KRISTELLER
SF-13-142 110X18 mm
SF-13-143 110X20 mm
SF-13-144 110X27 mm
SF-13-145 110X30 mm
SF-13-146 110X36 mm
220 mm

SF-13-147 - SF-13-150
KRISTELLER
Upper blades

SF-13-151 - SF-13-154
KRISTELLER
Lower blades

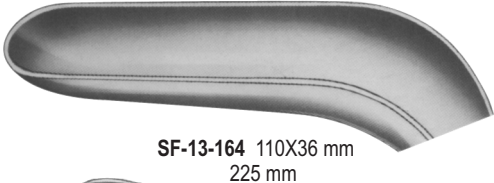
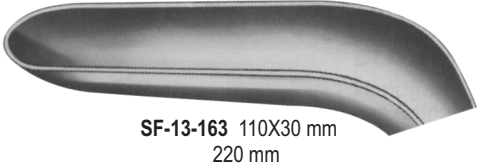
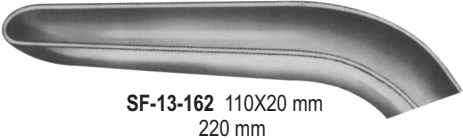
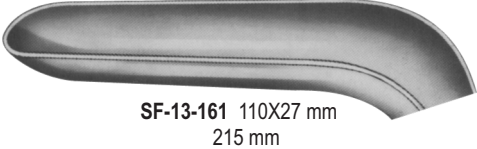
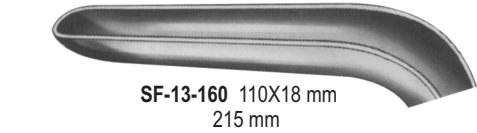
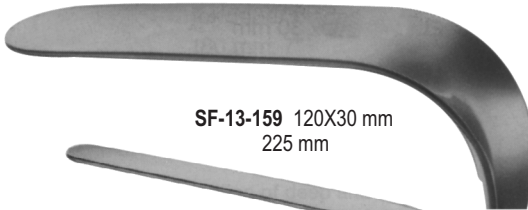
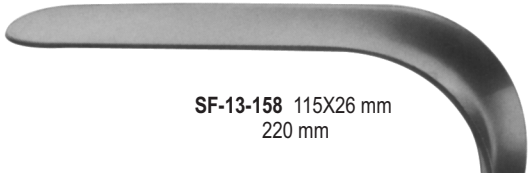
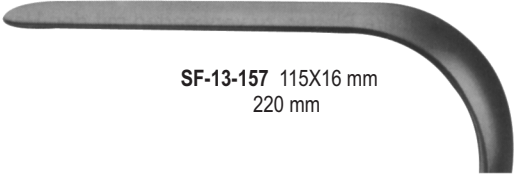
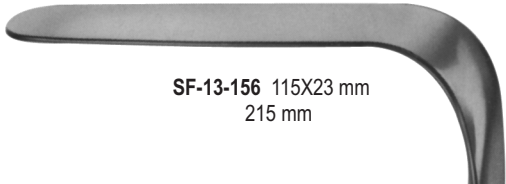
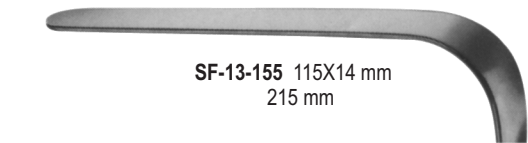

SF-13-155 - SF-13-159
KRISTELLER
Upper blades

VAGINAL SPECULA, UPPER LOWER BLADES

www.surgiforce.com

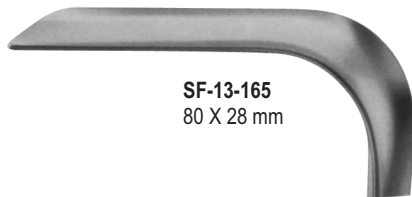

SF-13-165
80 X 28 mm



SF-13-166
85 X 35 mm



SF-13-167
85 X 40 mm



Slightly Concave

SF-13-165 - SF-13-167
KRISTELLER
205 mm



SF-13-168
76 X 38 mm

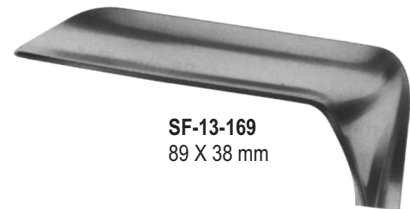

SF-13-169
89 X 38 mm



SF-13-170
102 X 38 mm



Slightly Concave

SF-13-168 - SF-13-170
JACKSON
175 mm

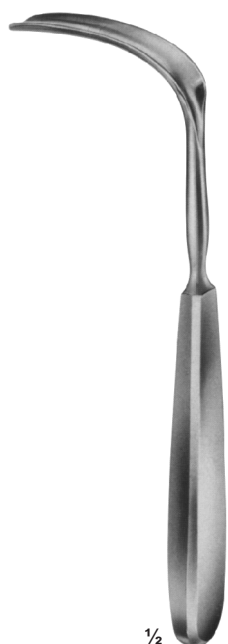

1/2
SF-13-171
BRAUN
180 mm

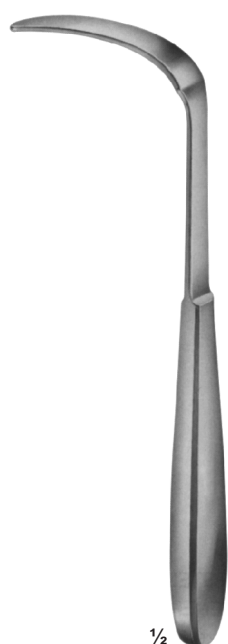

1/2
SF-13-172
BRAUN
180 mm



95 x 17 - 30 mm

SF-13-173
MATHIEU
For children
and virgins
210 mm

1/2



95 x 17-26 mm

SF-13-174
MATHIEU
for children and
virgins fitting
210 mm

1/2



SF-13-175
Handle with cold light
carrier for upper blades
280 mm

1/2





SF-13-190 - SF-13-194
BREISKY
WIENER MODELL/
VIENNA PATTERN
SF-13-190 100 X 20 mm
SF-13-191 100 X 25 mm
SF-13-192 100 X 30 mm
SF-13-193 100 X 35 mm
SF-13-194 100 X 40 mm
300 mm



SF-13-195 - SF-13-199
BREISKY
WIENER MODELL/
VIENNA PATTERN
SF-13-195 130 X 20 mm
SF-13-196 130 X 25 mm
SF-13-197 130 X 30 mm
SF-13-198 130 X 35 mm
SF-13-199 130 X 40 mm
320 mm



SF-13-200
DOYEN
lateral speculum
80 x 30 mm
250 mm



1/2

SF-13-201
SIMON
115 X 22 mm
275 mm



1/2

SF-13-202
AUVARD
65 X 38 mm - 28 mm
1,530 kg
with fixed weight
230 mm



1/2

SF-13-203 - SF-13-204
AUVARD
SF-13-203 75 X 42 mm
(40 mm)
SF-13-204 105 X 43 mm
(40 mm)
with detachable wight
230 mm

SF-13-205
80 X 30

SF-13-208
55 X 40 - 60 mm

SF-13-206
85 X 35

SF-13-209
70 X 45 - 70 mm

SF-13-207
85 X 40

SCHERBACK
SF-13-205 - SF-13-209
Set consisting of:
handle
weight
5 blades 1/3

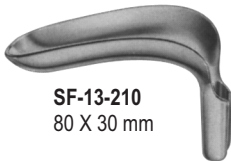

SCHERBACK
SF-13-210 - SF-13-217
Set consisting of:
2 handle
8 blades 1/3

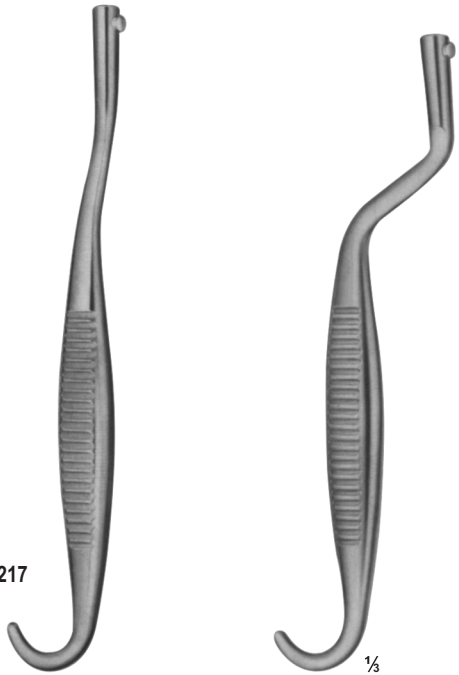



Surgiforce Instruments



Opposite Surgical Association,
Malkay Kalan, Marala Road,
Sialkot-51050 Pakistan.



+92 523 559131



info@surgiforce.com
sales@surgiforce.com



www.surgiforce.com



Our Certifications:

ISO 9001

CE Certified

EN 13485:2012

ISO 7153-1

ISO 7151

ISO 17664:2004

ISO 13402

ISO 15223

