

Page
289-311

- Dilators
- Biopsy Instruments And Curettes
- Uterine Probes, Uterine Dressing - Tenaculum
- Ovum Forceps
- Uterine Elevating Forceps





1/2

SF-15-101 - SF-15-143
HEGAR
with very conical point
185 mm

SF-15-101	1	mm	SF-15-123	23	mm
SF-15-102	2	mm	SF-15-124	24	mm
SF-15-103	3	mm	SF-15-125	25	mm
SF-15-104	4	mm	SF-15-126	26	mm
SF-15-105	5	mm	SF-15-127	1	1/2mm
SF-15-106	6	mm	SF-15-128	2	1/2mm
SF-15-107	7	mm	SF-15-129	3	1/2mm
SF-15-108	8	mm	SF-15-130	4	1/2mm
SF-15-109	9	mm	SF-15-131	5	1/2mm
SF-15-110	10	mm	SF-15-132	6	1/2mm
SF-15-111	11	mm	SF-15-133	7	1/2mm
SF-15-112	12	mm	SF-15-134	8	1/2mm
SF-15-113	13	mm	SF-15-135	9	1/2mm
SF-15-114	14	mm	SF-15-136	10	1/2mm
SF-15-115	15	mm	SF-15-137	11	1/2mm
SF-15-116	16	mm	SF-15-138	12	1/2mm
SF-15-117	17	mm	SF-15-139	13	1/2mm
SF-15-118	18	mm	SF-15-140	14	1/2mm
SF-15-119	19	mm	SF-15-141	15	1/2mm
SF-15-120	20	mm	SF-15-142	16	1/2mm
SF-15-121	21	mm	SF-15-143	17	1/2mm
SF-15-122	22	mm			



1/2

SF-15-144 - SF-15-152
HEGAR
205 mm

SF-15-144	1+2	mm
SF-15-145	3+4	mm
SF-15-146	5+6	mm
SF-15-147	7+8	mm
SF-15-148	9+10	mm
SF-15-149	11+12	mm
SF-15-150	13+14	mm
SF-15-151	15+16	mm
SF-15-152	17+18	mm

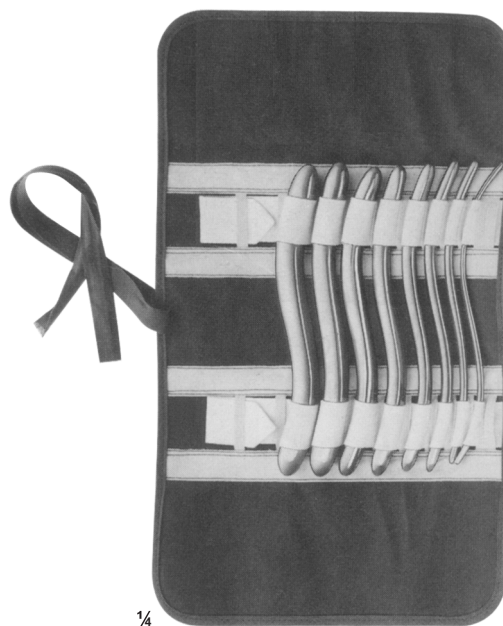

1/4

SF-15-153
HEGAR
Uterine dilator set, in canvas
roll with 8 dilators.



SF-15-154
HEGAR
Dilator set consisting of:
14 Dilators,
1 Rack for dilators (4 - 12 mm)
1 Rack for Dilators (13 - 17 mm)
1 Metal case only,
with hinged lid, stainless 200 X 100 X 35 mm

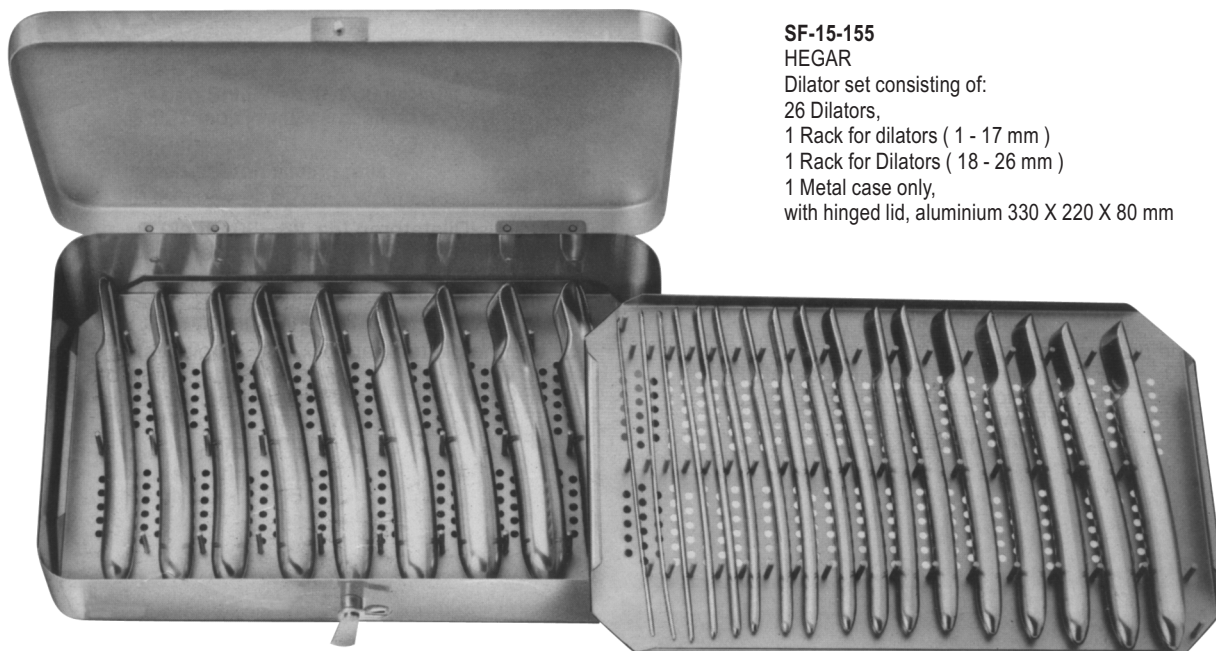

SF-15-155
HEGAR
Dilator set consisting of:
26 Dilators,
1 Rack for dilators (1 - 17 mm)
1 Rack for Dilators (18 - 26 mm)
1 Metal case only,
with hinged lid, aluminium 330 X 220 X 80 mm

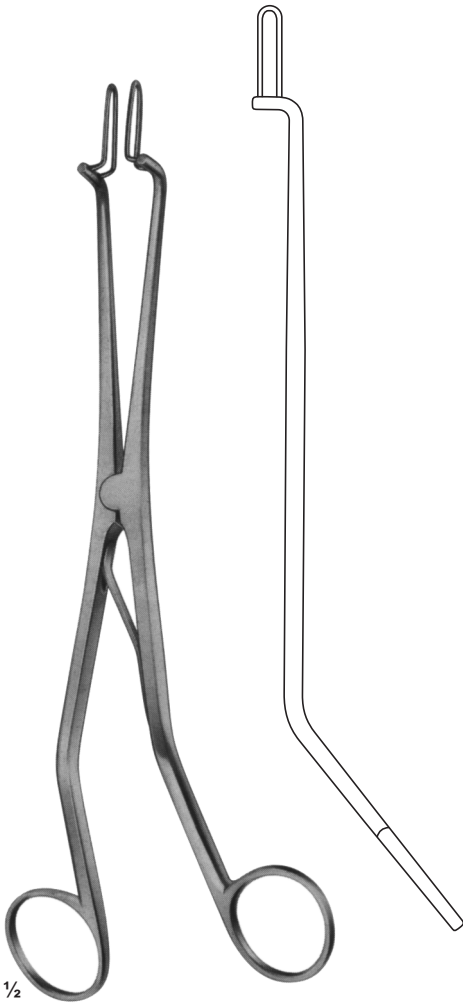

SF-15-156
KOGAN
Endospecula for cervix
and urethra, without ratchet
240 mm

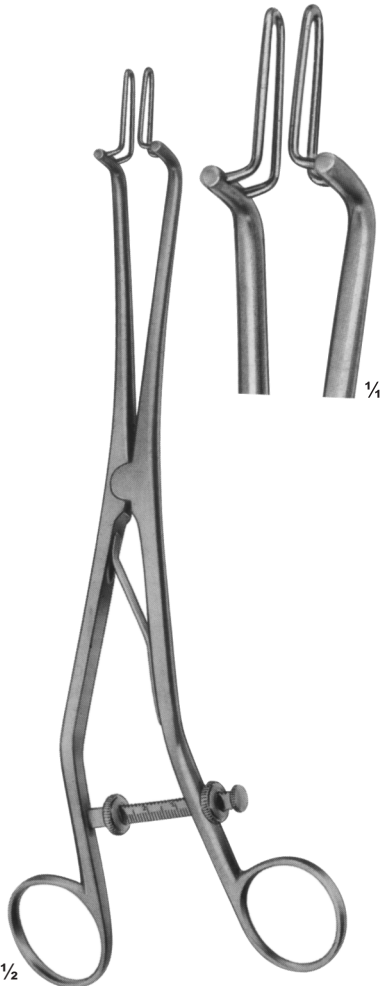

SF-15-157
KOGAN
Endospecula for cervix
and urethra, with
scale-ratchet and fixing screws
240 mm

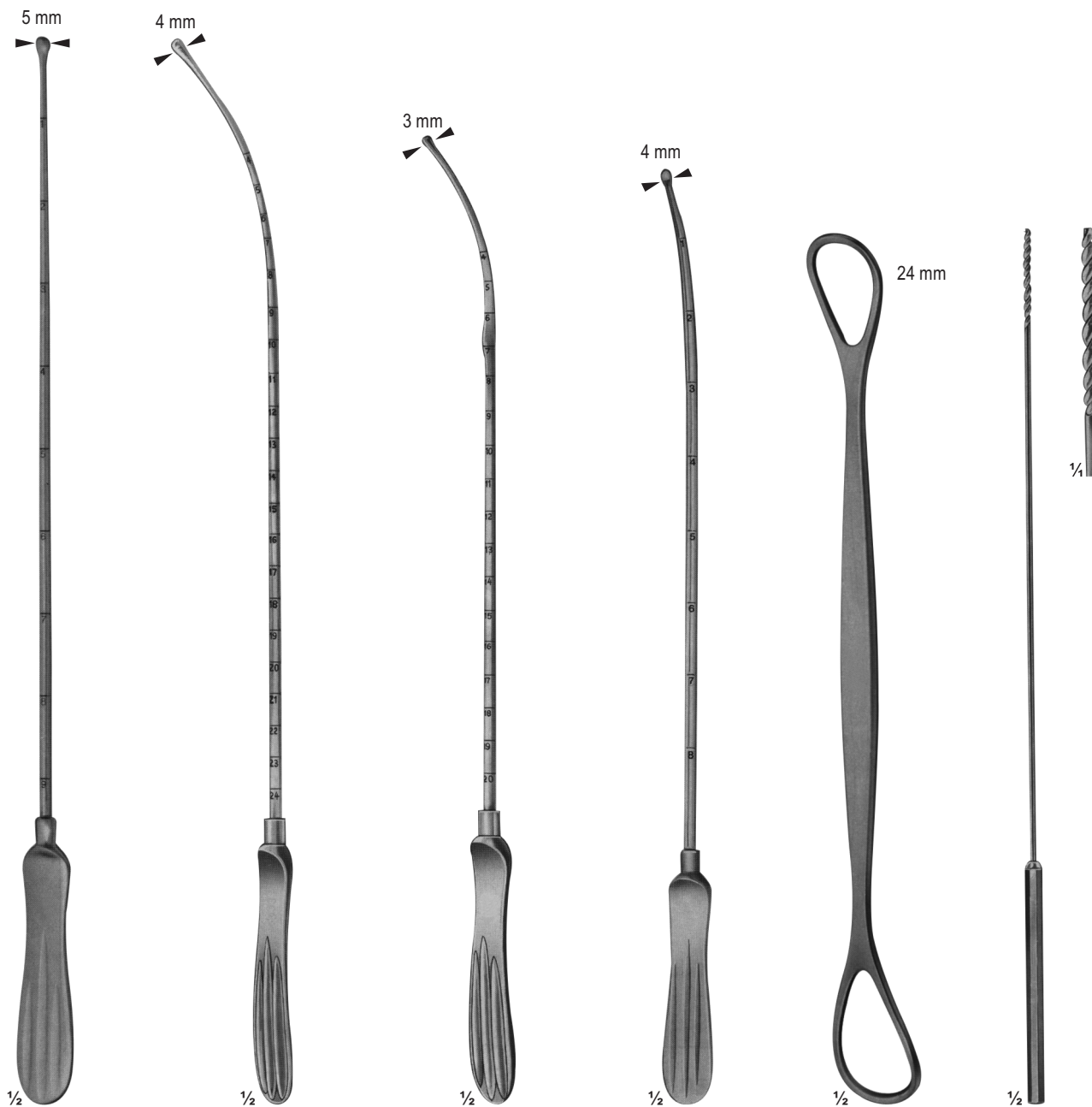

SF-15-158
MAYO
biegsam malleable
330 mm

SF-15-159
SIMS
biegsam malleable
330 mm

SF-15-160
MARTIN
330 mm

SF-15-161
SIMPSON
malleable
silver-plated
290 mm

SF-15-162
BRAUN
Uterine
depressor
270 mm

SF-15-163
Cotton
applicator
270 mm

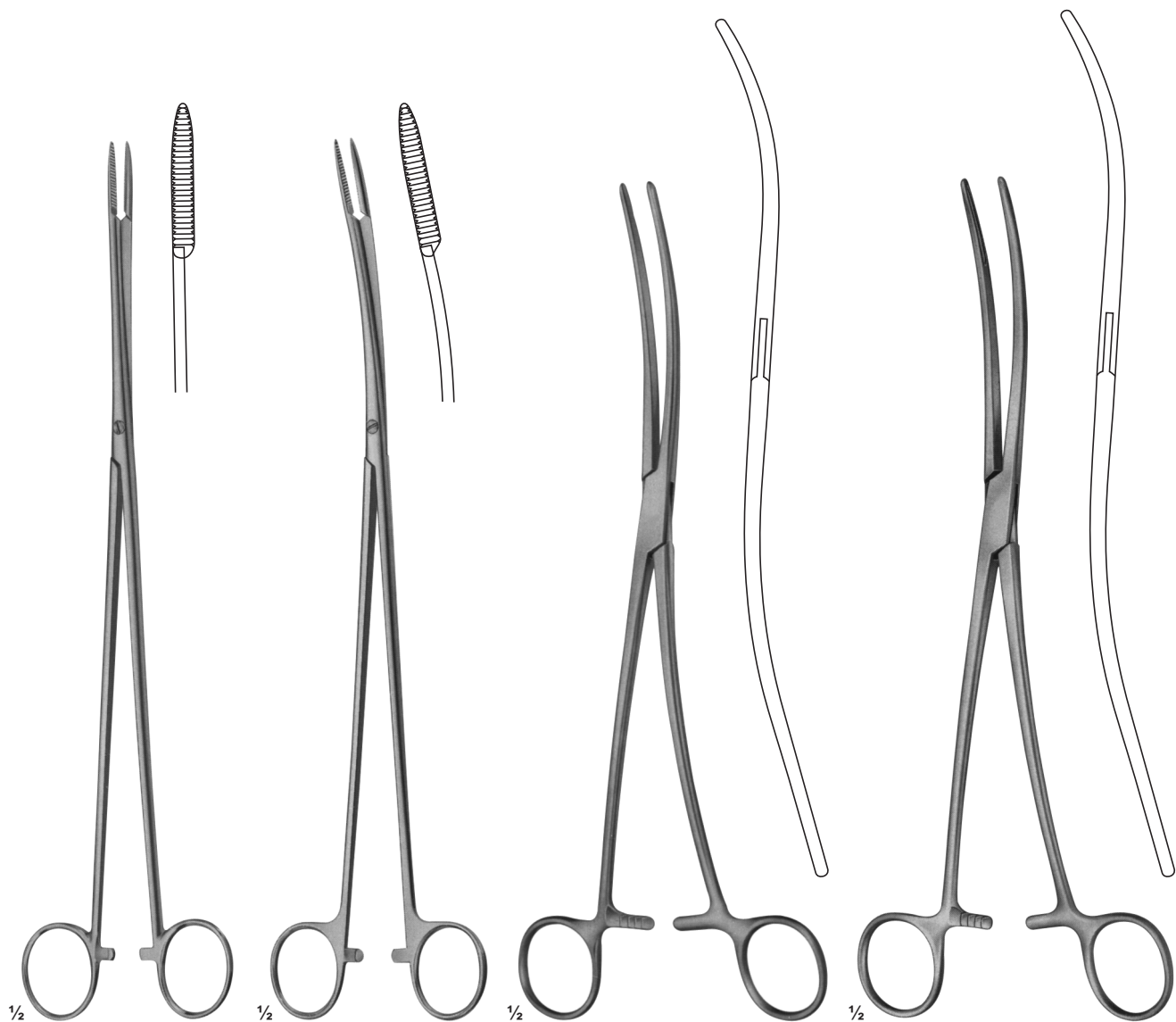

SF-15-164
PELKMANN
260 mm

SF-15-165
PELKMANN
260 mm

SF-15-166
BOZEMANN
250 mm

SF-15-167
BOZEMANN
255 mm

Jaws with longitudinal groove

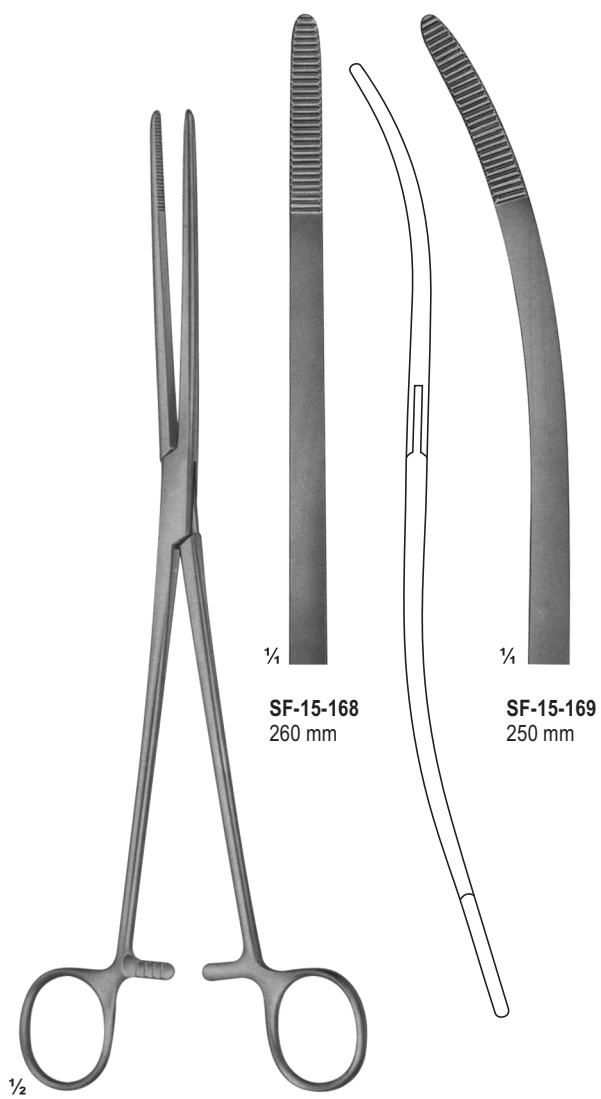

SF-15-168 - SF-15-169
BOZEMANN

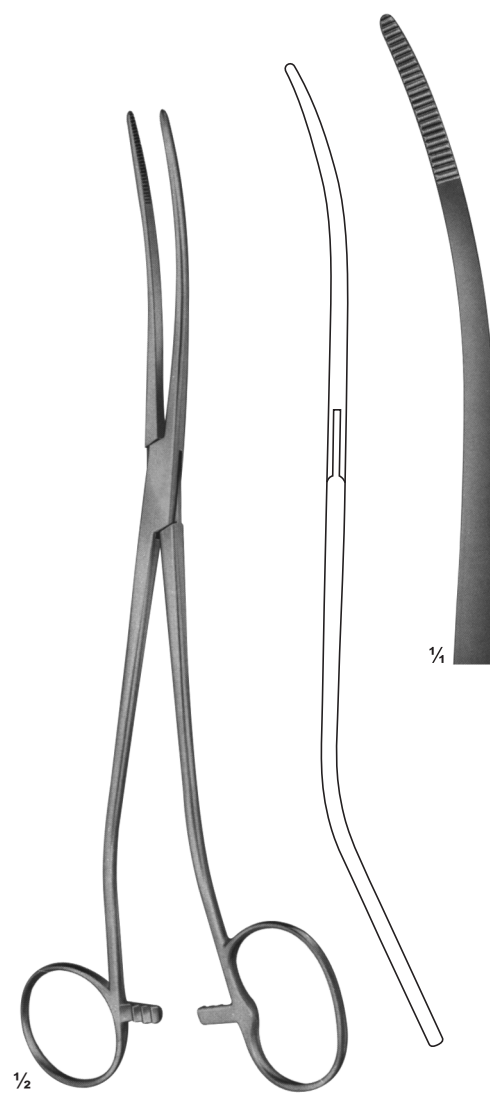

SF-15-170
BOZEMANN-DOUGLAS
260 mm

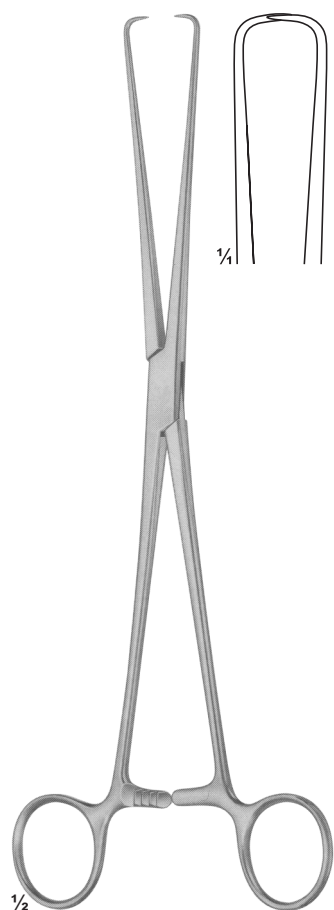

SF-15-171
BRAUN
slender type
250 mm



SF-15-172
SCHRODER
250 mm



SF-15-173
POZZI
heavy type
255 mm

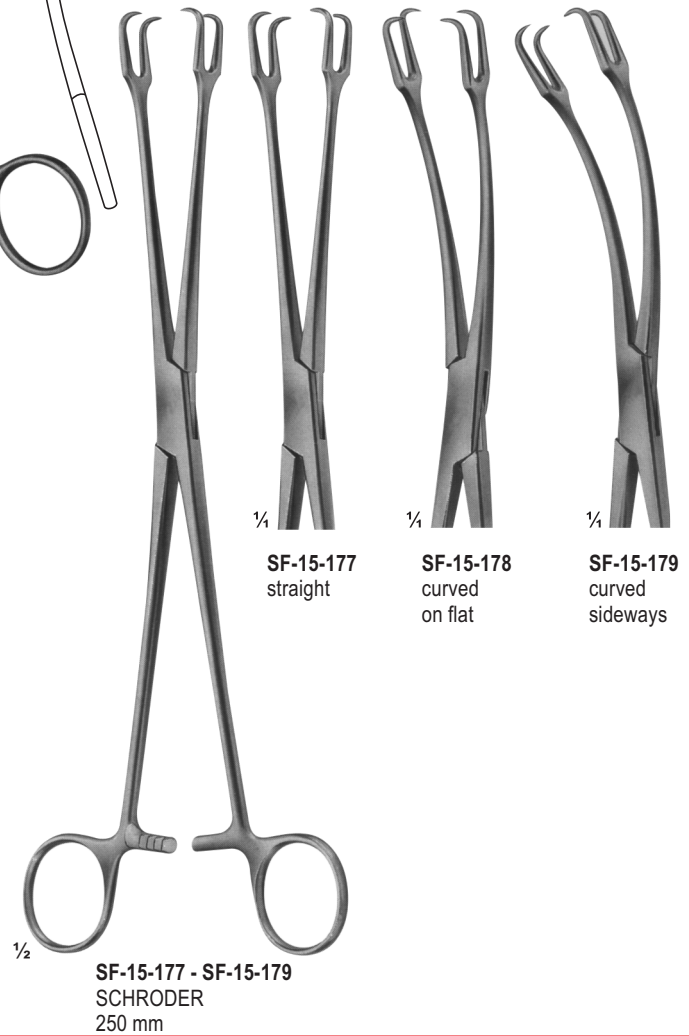
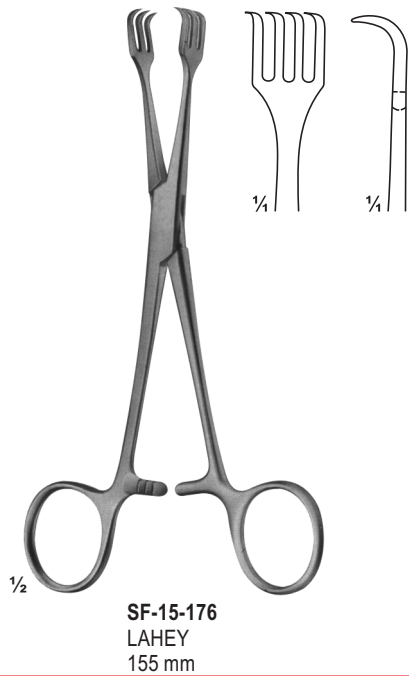
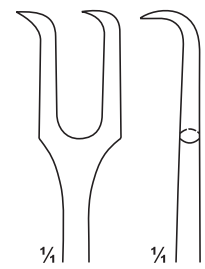
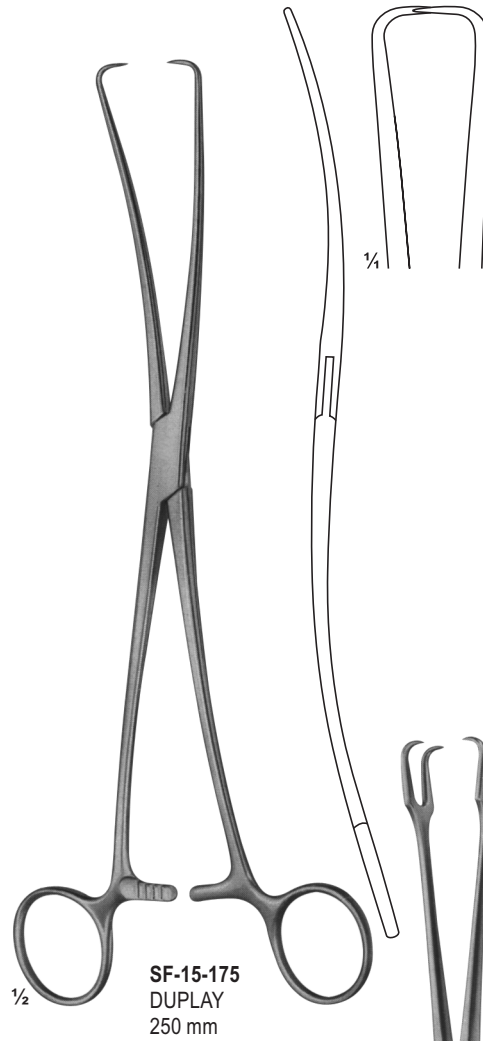
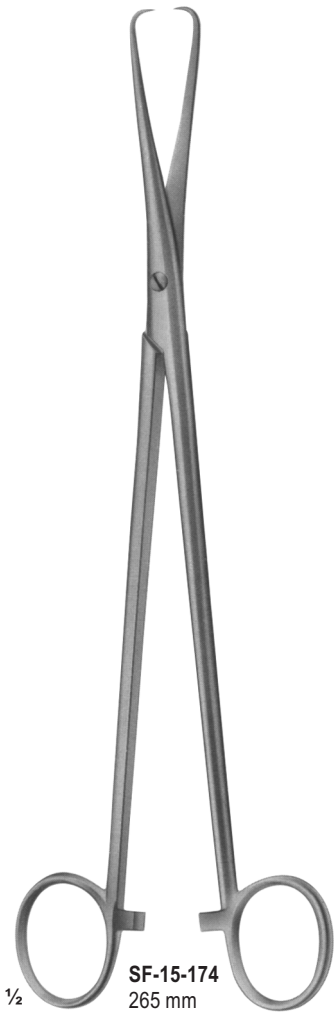

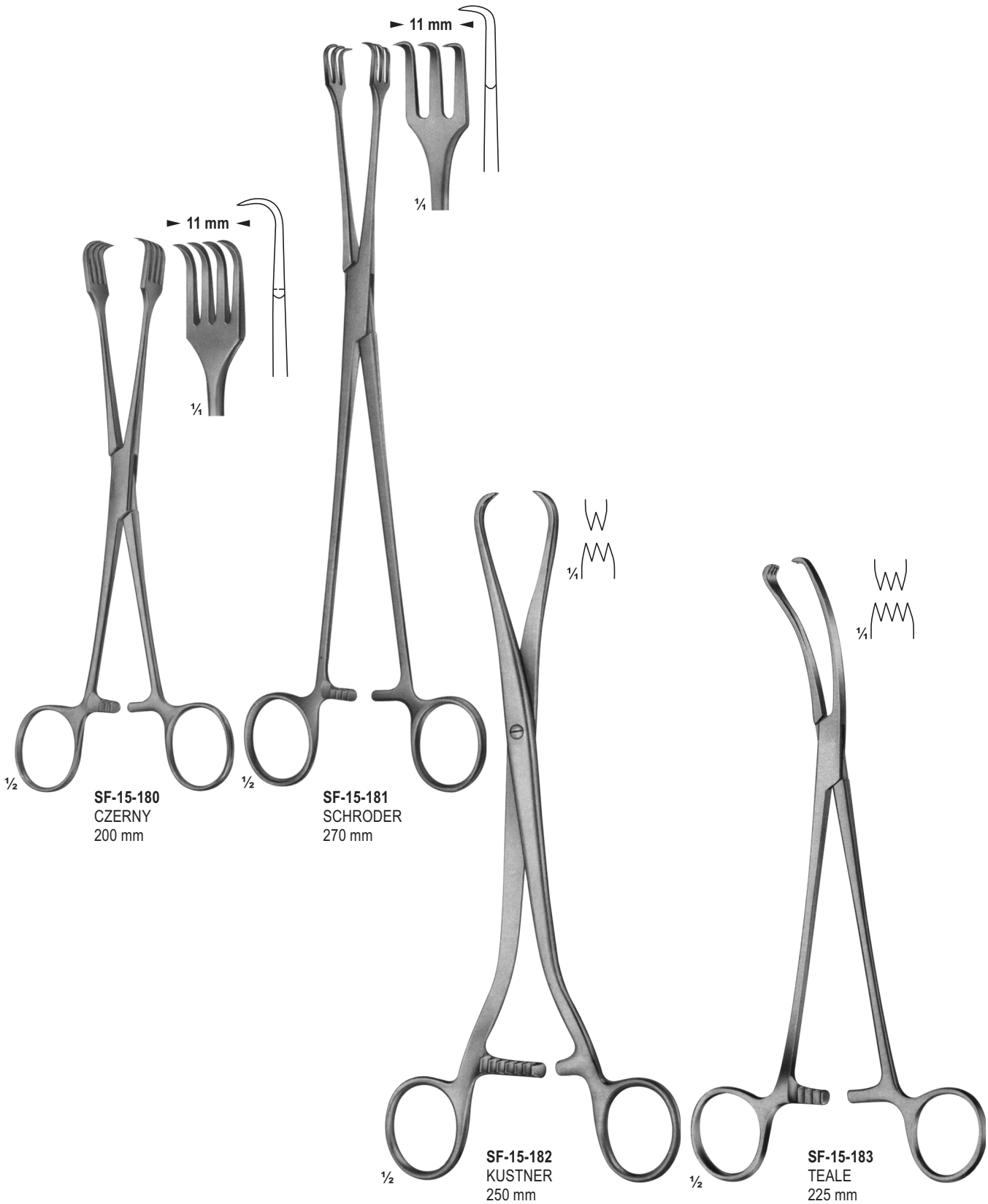

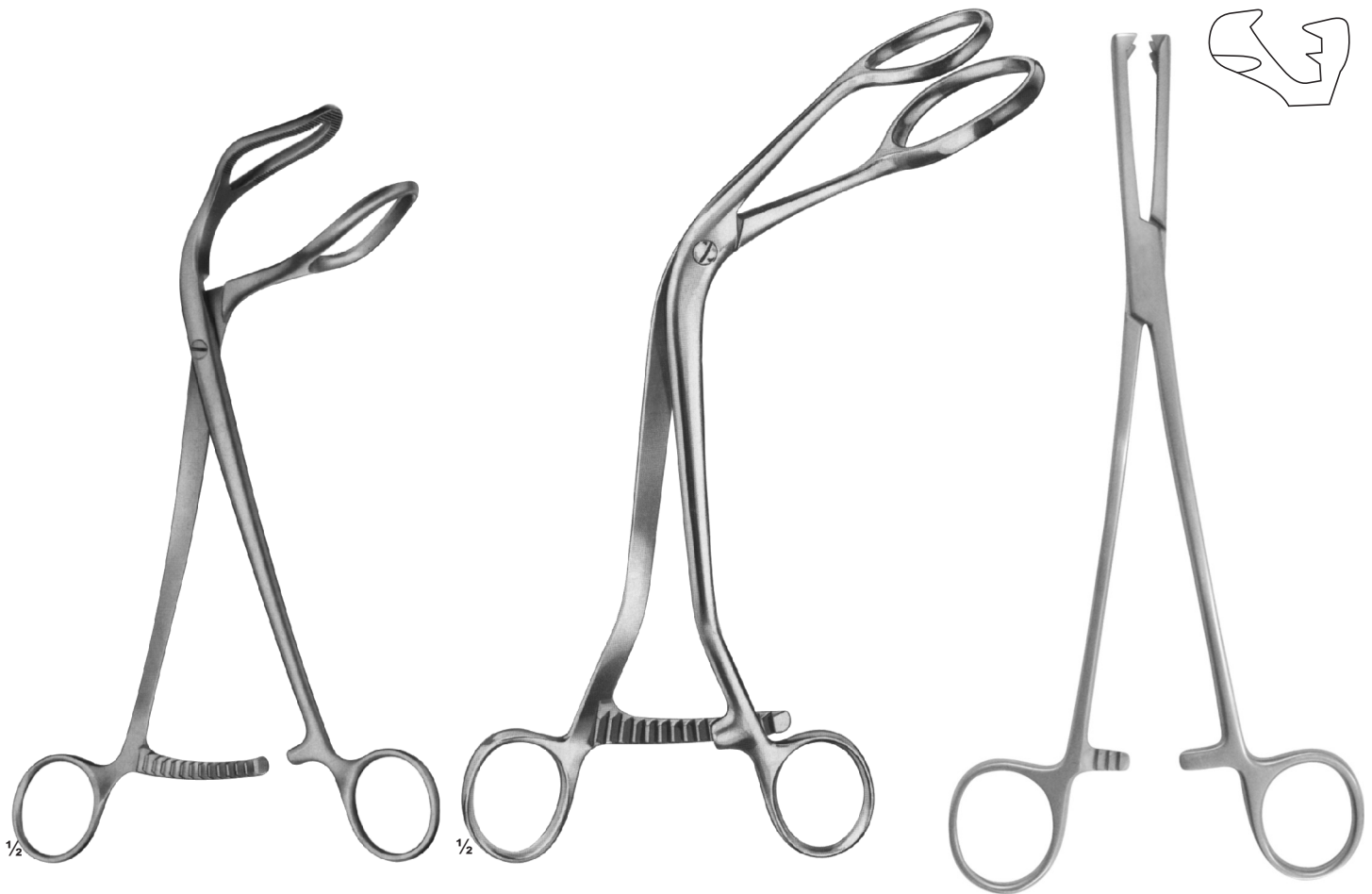

SF-15-184
SOMER
235 mm

SF-15-185
STRASSMANN
260 mm

SF-15-186
JACOBS
8.5 mm

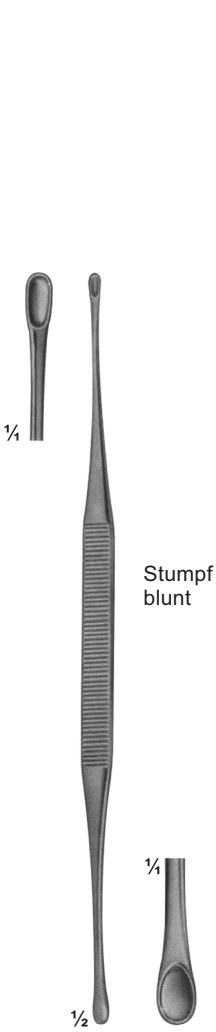

SF-15-187
ASCH
Uterine
Secretion scoop
200 mm

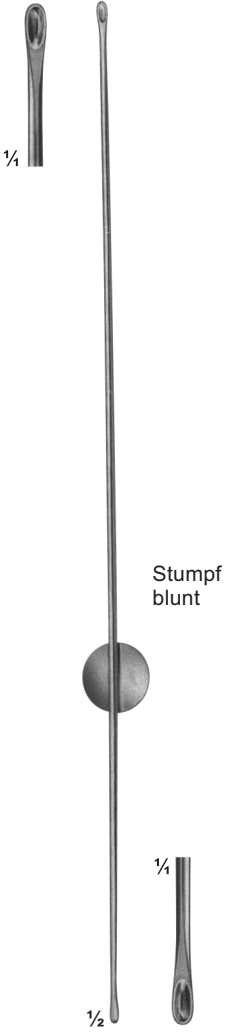

SF-15-188
Uterine
Secretion scoop
270 mm



SF-15-189
NOVAK-SCHOECKAERT
Endometrial biopsy
curette
240 mm



SF-15-190
RANDALL
Endometrial biopsy
curette
240 mm

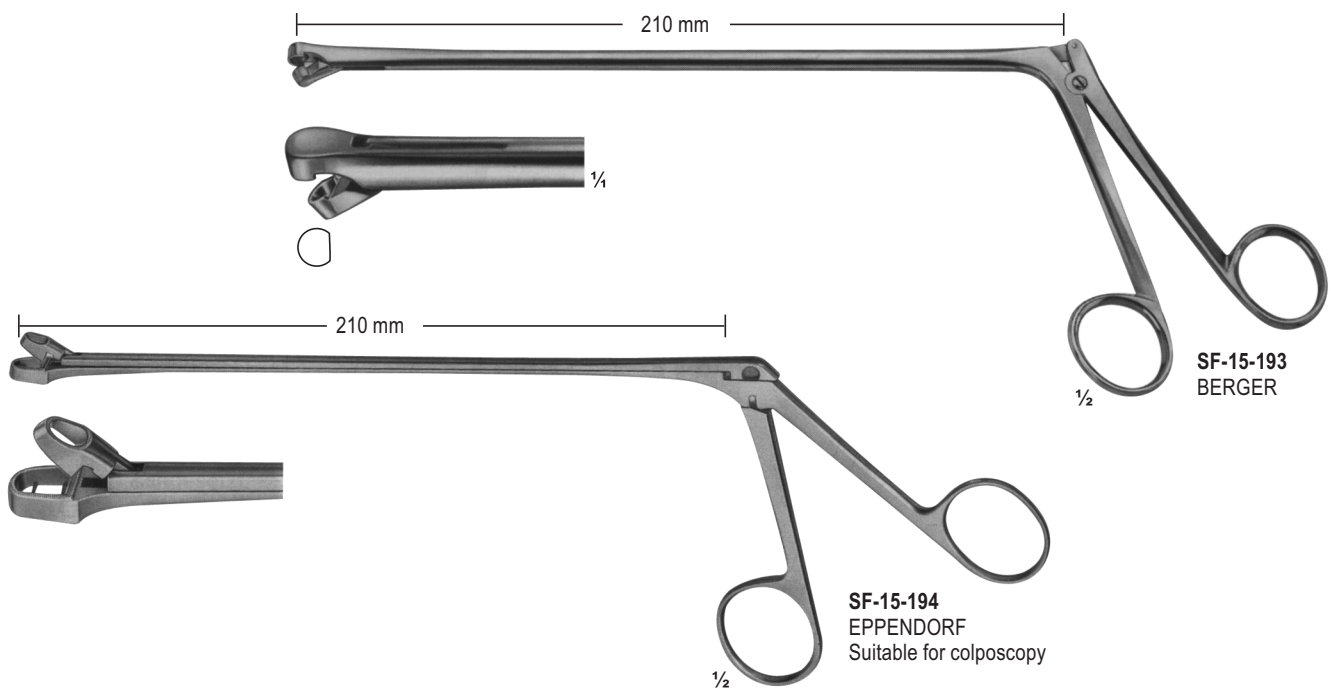
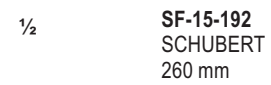
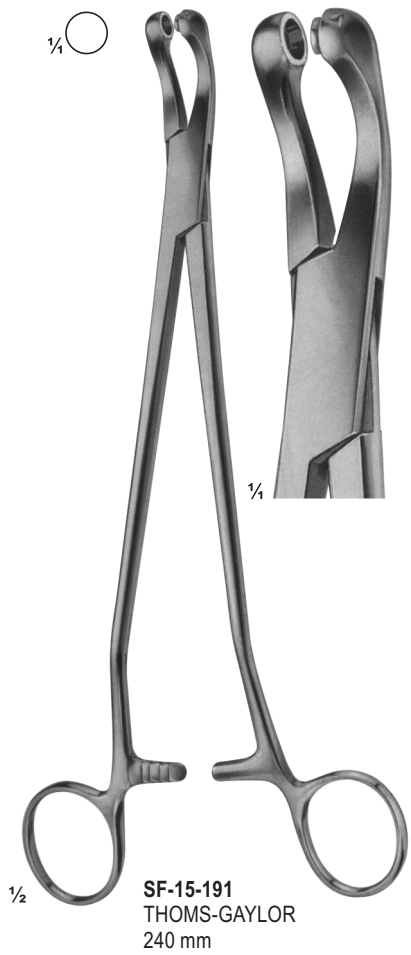

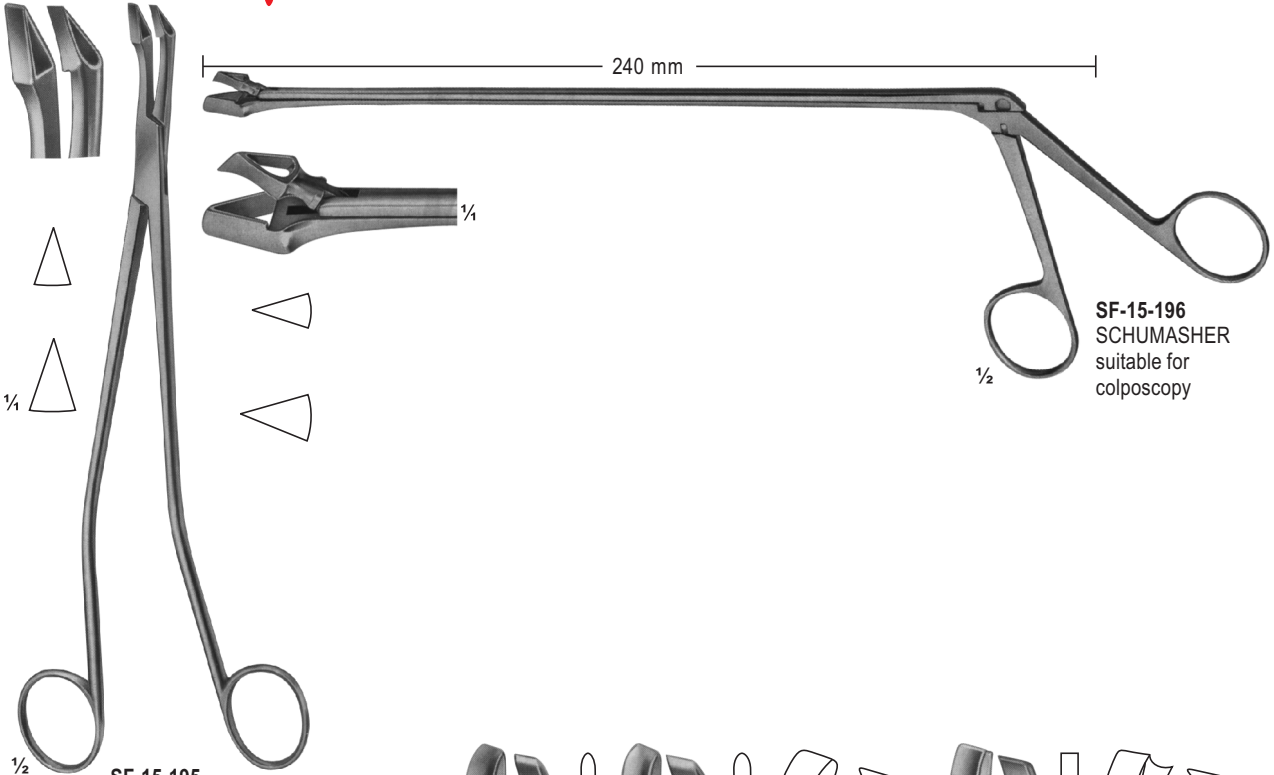

SF-15-195
SCHUMASHER
240 mm

SF-15-196
SCHUMASHER
suitable for
colposcopy

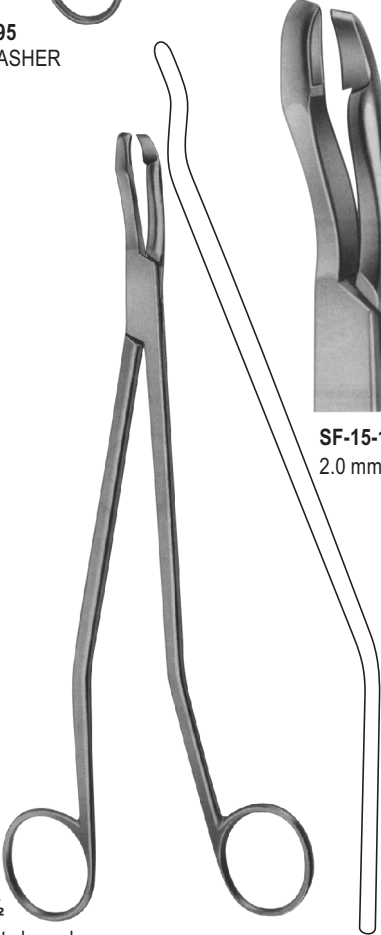

SF-15-197 - SF-15-199
SEIDL DBP
Biopsy forceps, bayonet shaped
for portio, vagina and vulva
240 mm



SF-15-197
2.0 mm



SF-15-198
2.4 mm



SF-15-199
2.4 mm

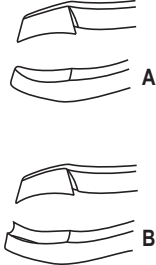
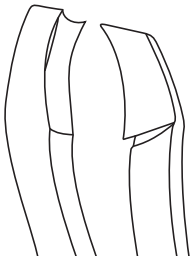

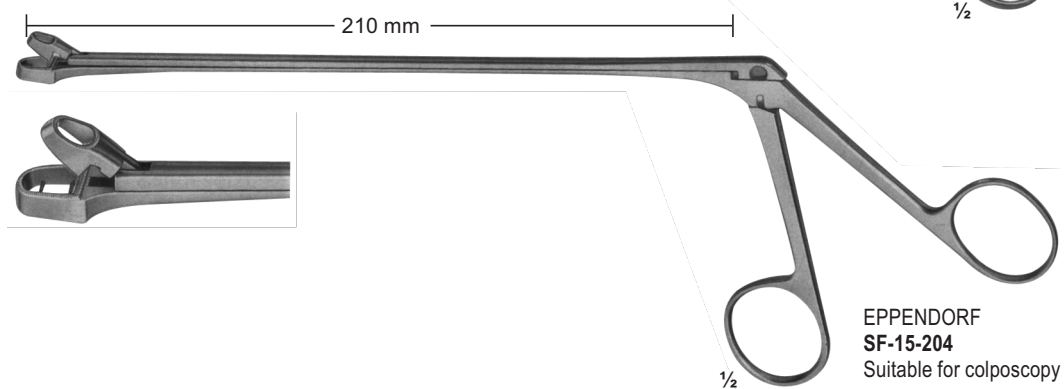
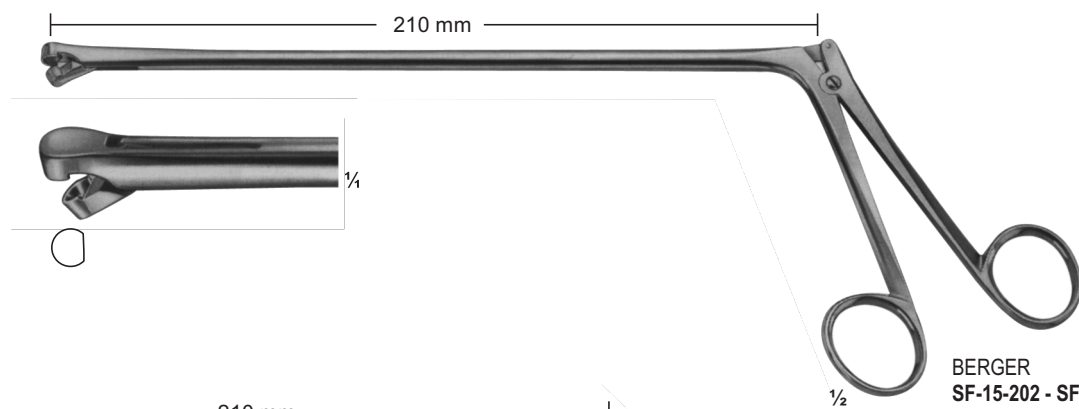
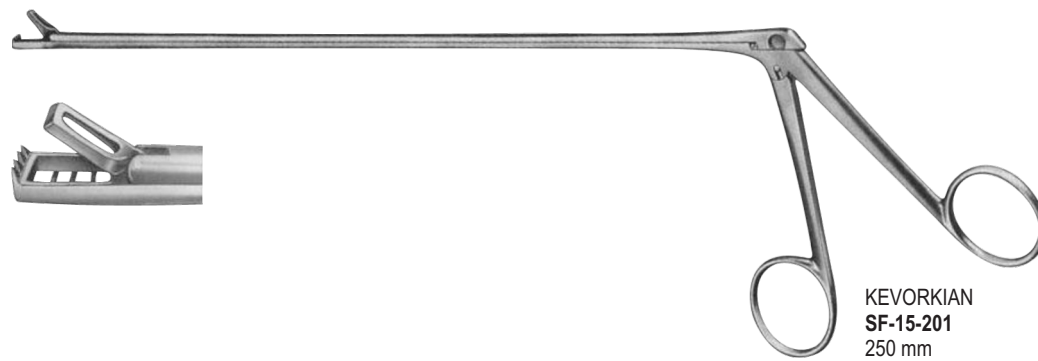
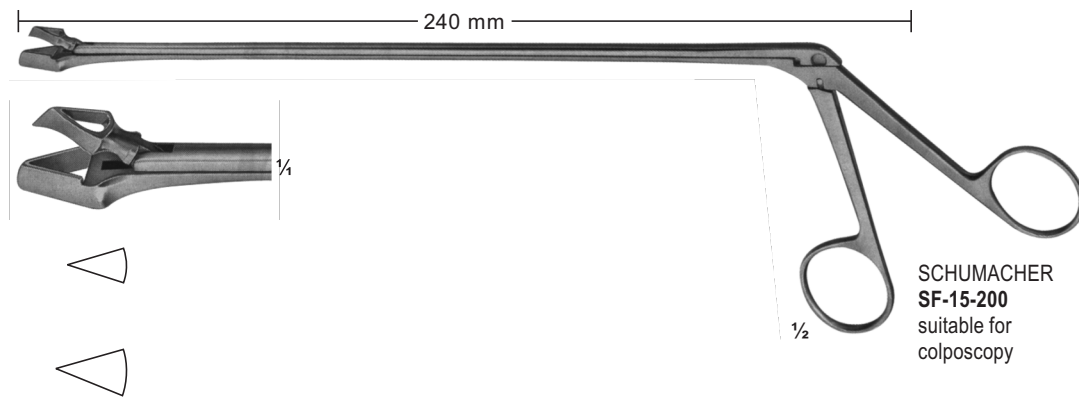

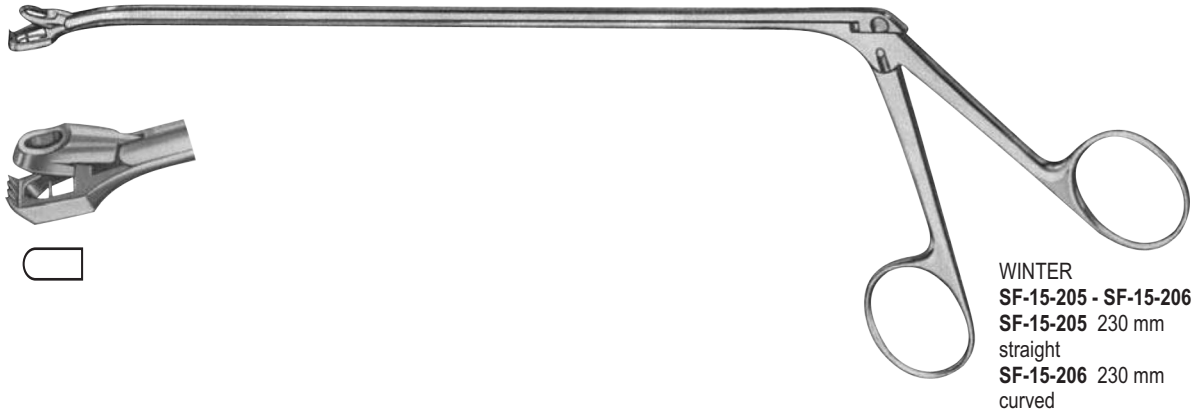

WINTER
SF-15-205 - SF-15-206
SF-15-205 230 mm
 straight
SF-15-206 230 mm
 curved

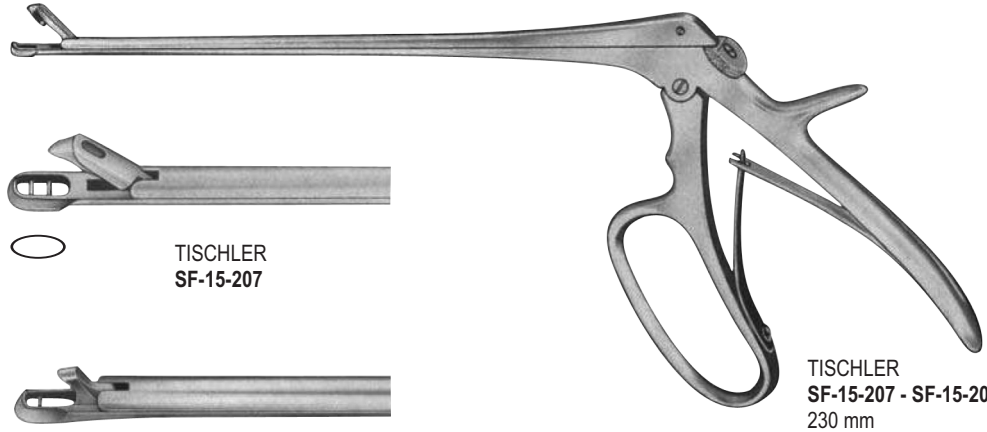

TISCHLER
SF-15-207

TISCHLER
SF-15-207 - SF-15-209
 230 mm



TISCHLER-MINI
SF-15-208



KEVORKIAN-PACIFIC
SF-15-209

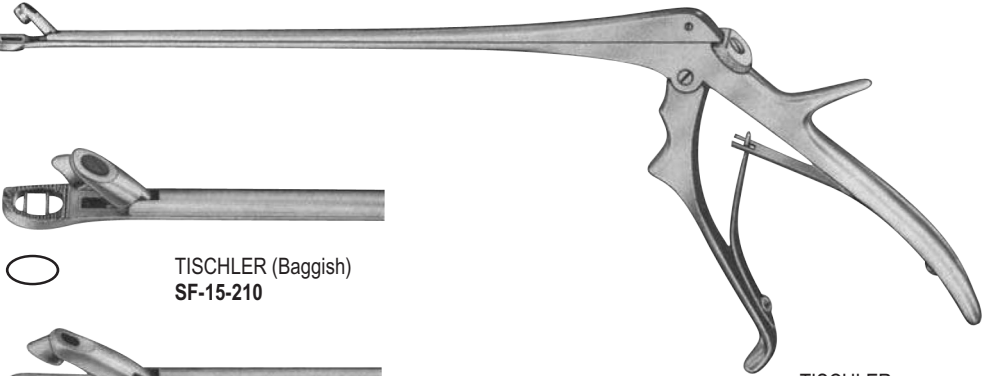

TISCHLER (Baggish)
SF-15-210

TISCHLER
SF-15-210 - SF-15-211
 230 mm



TISCHLER-BURKE
SF-15-211

240 mm



1/2

SCHUMACHER
NO-112
suitable for
colposcopy

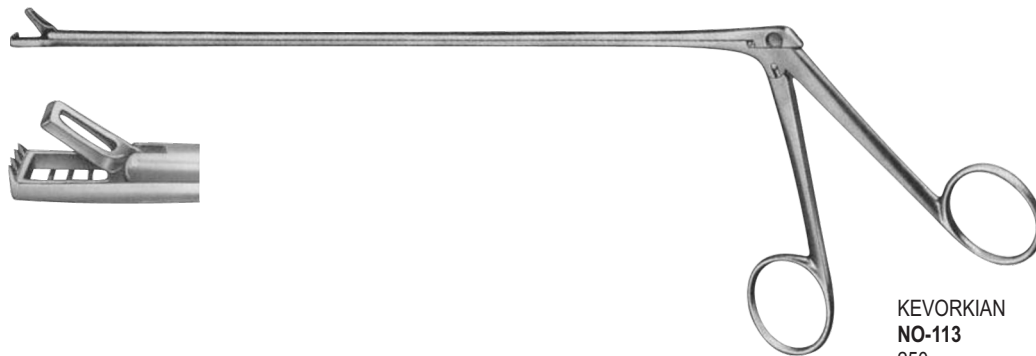

KEVORKIAN
NO-113
250 mm

210 mm

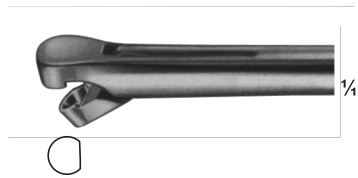

1/2

BERGER
NO-114 - NO-115
NO-114
19 cm / 3 mm
NO-115
19 cm / 5 mm

210 mm

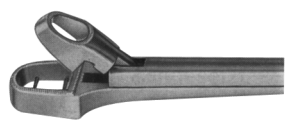

1/2

EPPENDORF
NO-116
Suitable for colposcopy

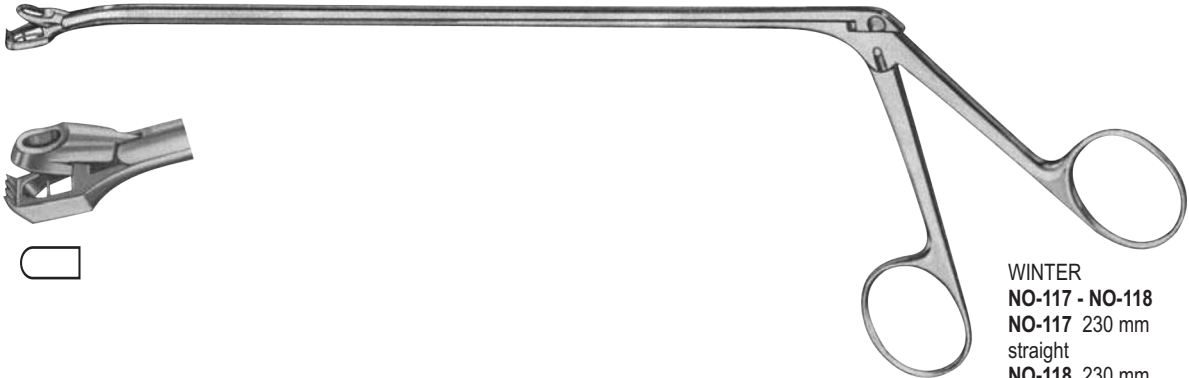

WINTER
NO-117 - NO-118
NO-117 230 mm
straight
NO-118 230 mm
curved

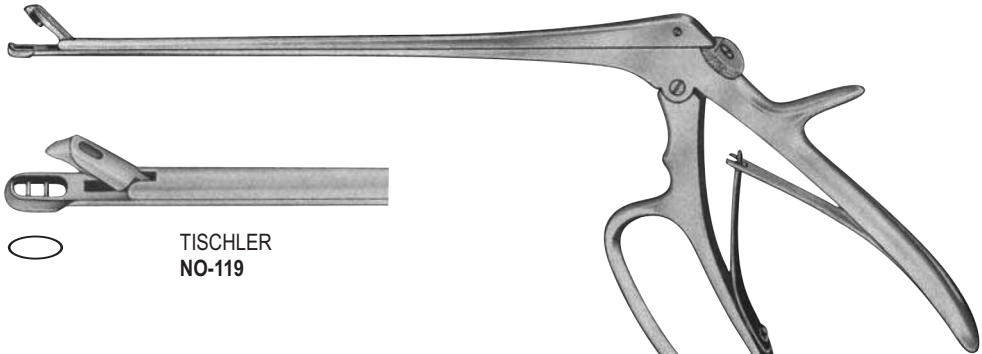

TISCHLER
NO-119

TISCHLER
NO-119 - NO-121
230 mm



TISCHLER-MINI
NO-120



KEVORKIAN-PACIFIC
NO-121

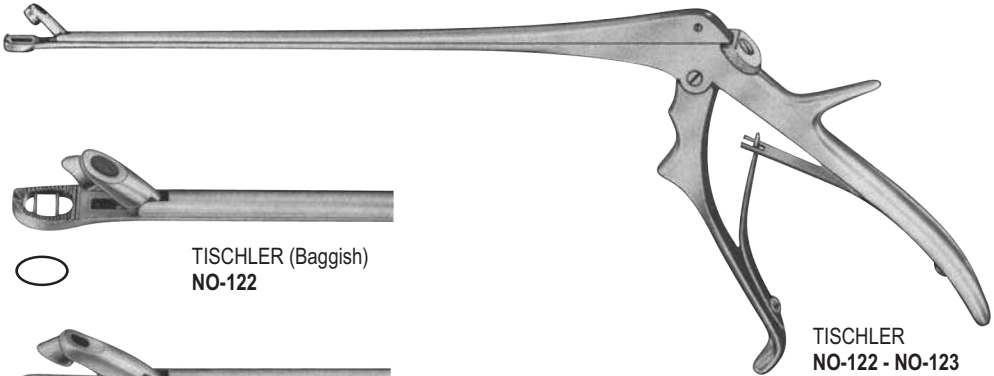

TISCHLER (Baggish)
NO-122

TISCHLER
NO-122 - NO-123
230 mm

TISCHLER-BURKE
NO-123

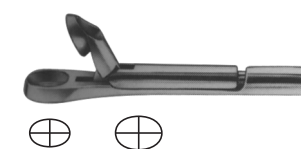
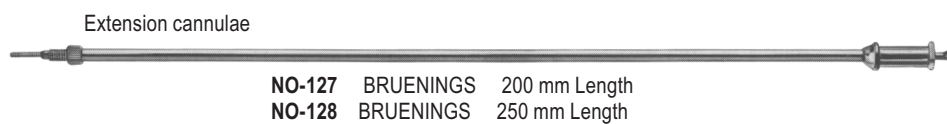
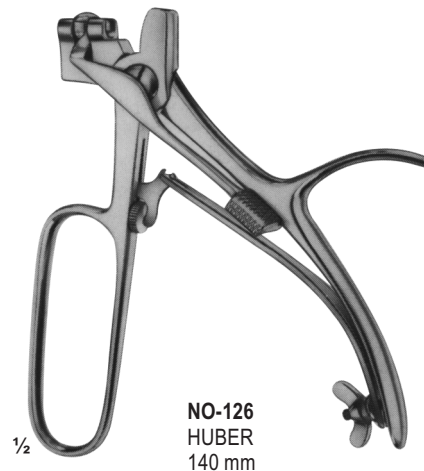
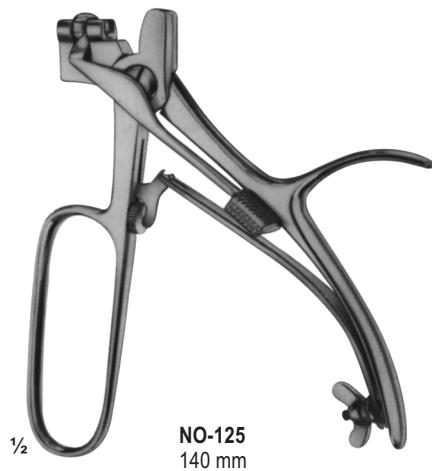
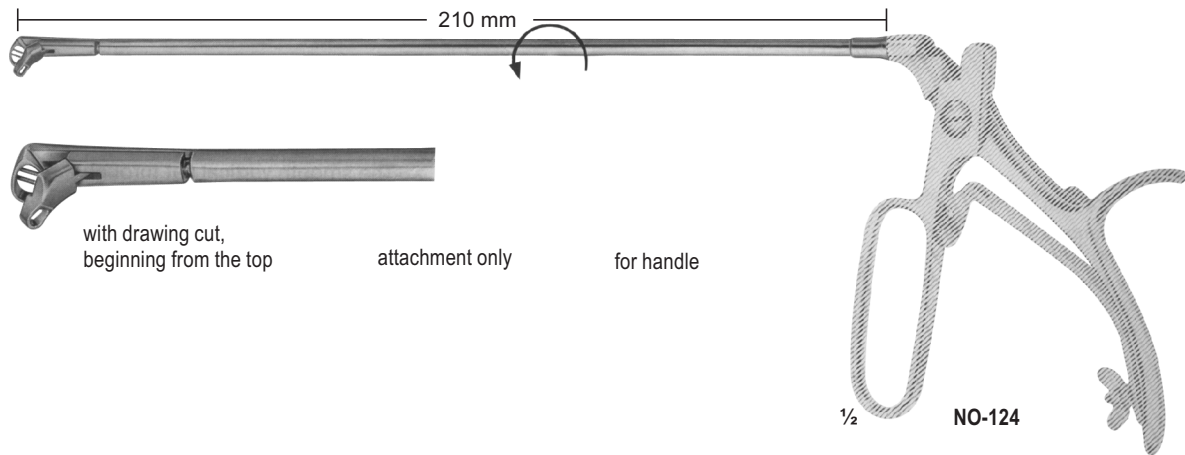

NO-129 KRAUSE (Biopsy tip)

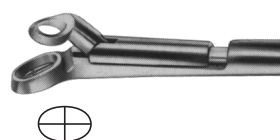

NO-130 SCHEINMANN (Biopsy tip)

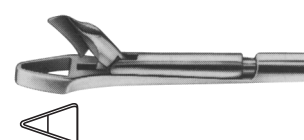

NO-131 SCHEINMANN (Biopsy tip)
with drawing cut

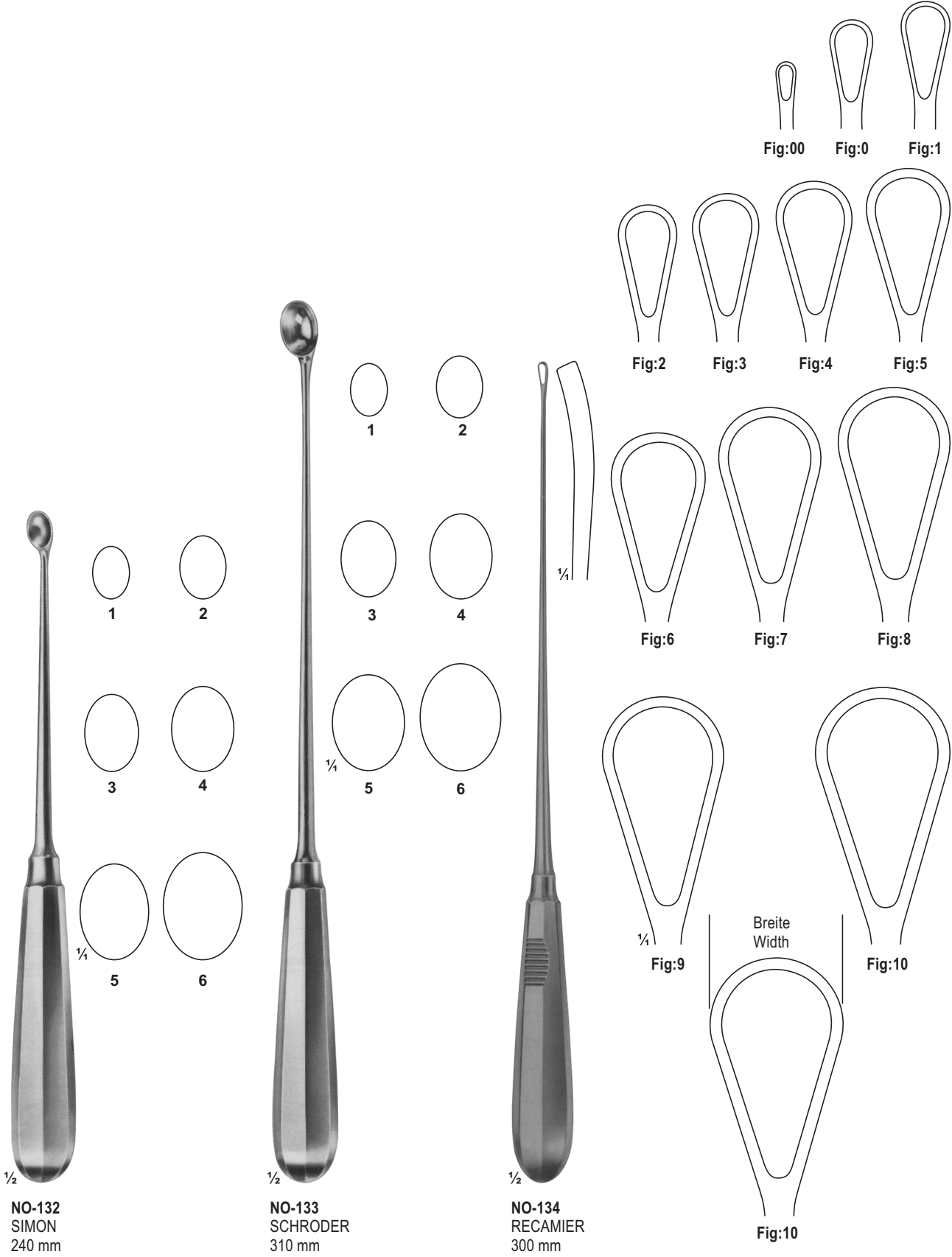

NO-132
SIMON
240 mm

NO-133
SCHRODER
310 mm

NO-134
RECAMIER
300 mm

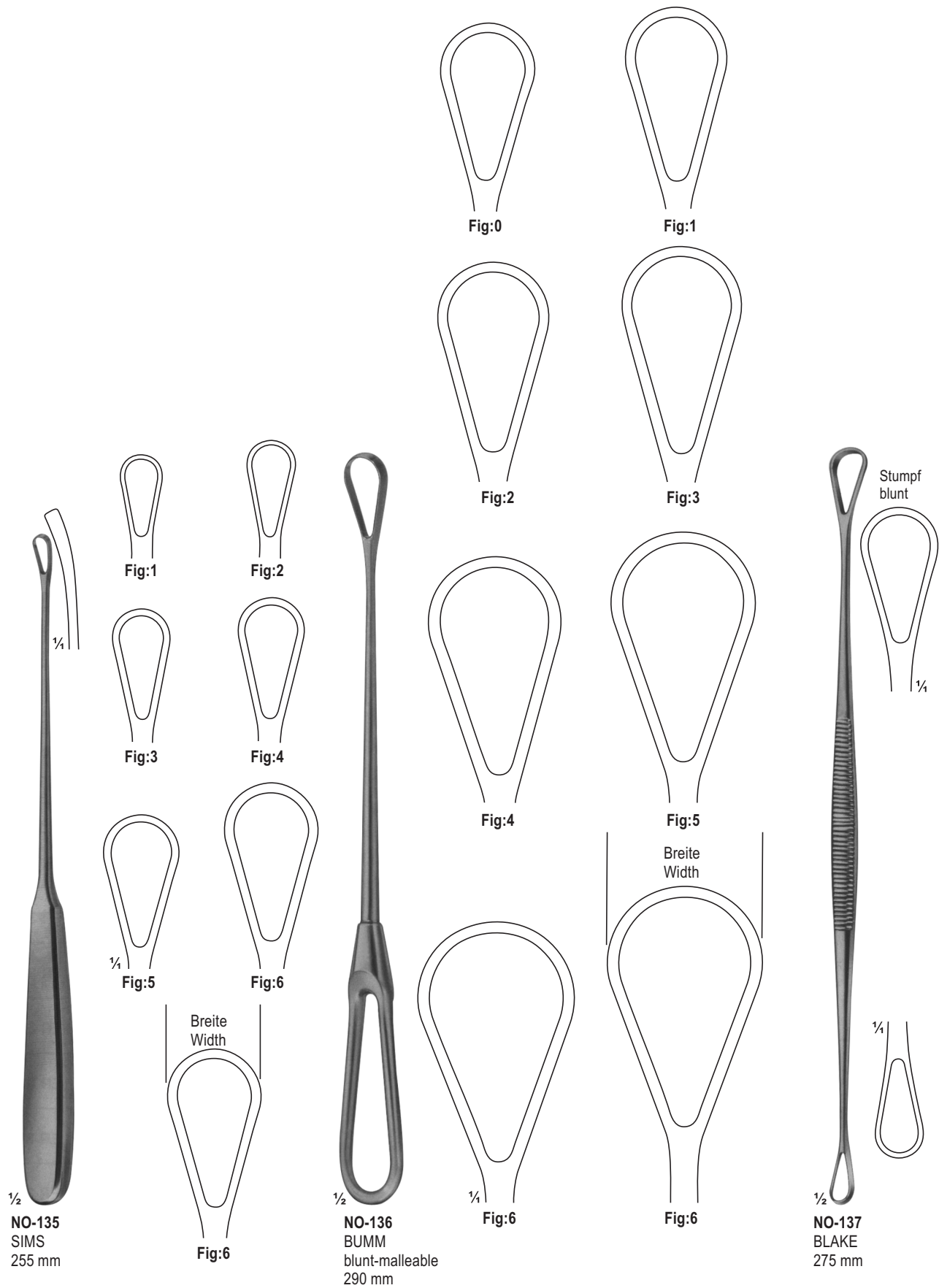



NO-138
COLLIN
300 mm

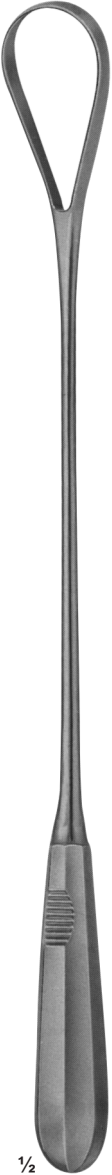

NO-139
RECAMIER
blunt-rigid
360 mm

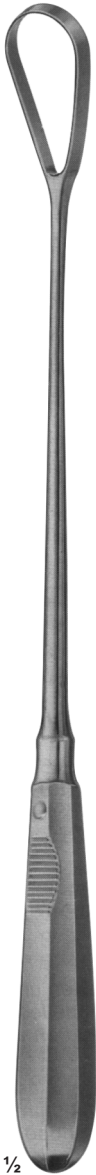
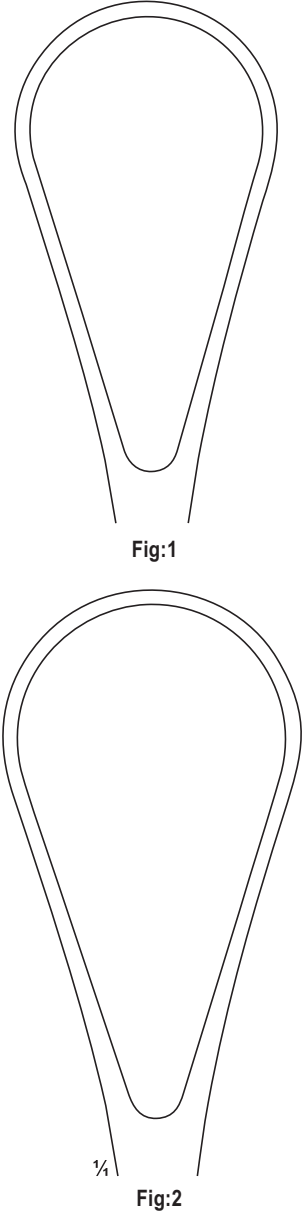

NO-140
BUMM
310 mm

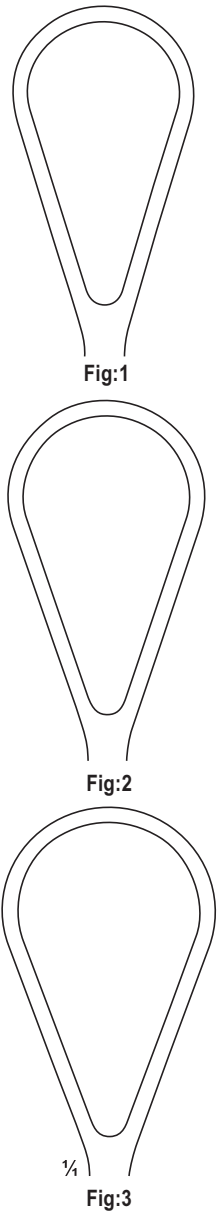

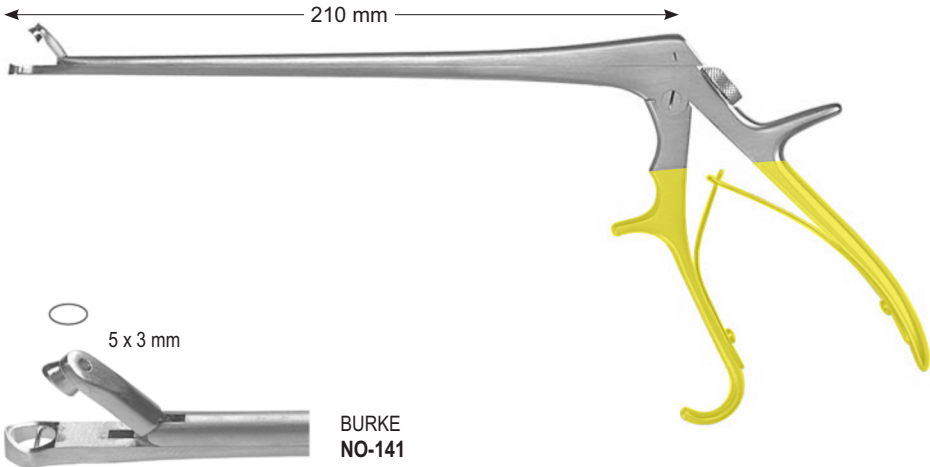

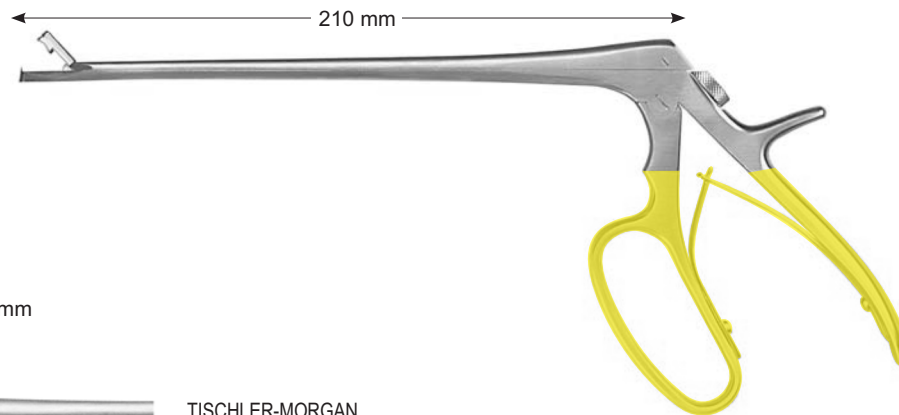

○ 7 x 3 mm



TISCHLER-MORGAN
NO-142

□ 2.3 x 4 mm



MINI-TOWNSEND
NO-143

▤ 9 x 3 mm



TISCHLER-KEVORKIAN
NO-145

□ 2.3 x 4 mm



BABY-TISCHLER
NO-144

▤ 9 x 3 mm



KEVORKIAN-PACIFIC
NO-146



Surgiforce Instruments



Opposite Surgical Association,
Malkay Kalan, Marala Road,
Sialkot-51050 Pakistan.



+92 523 559131



info@surgiforce.com
sales@surgiforce.com



www.surgiforce.com



Our Certifications:

ISO 9001

CE Certified

EN 13485:2012

ISO 7153-1

ISO 7151

ISO 17664:2004

ISO 13402

ISO 15223



No.3012922148