

Page
312-374

- Cardiovascular And Thoracic Surgery
- Muller Vessel Clips
- Bulldog Clamps

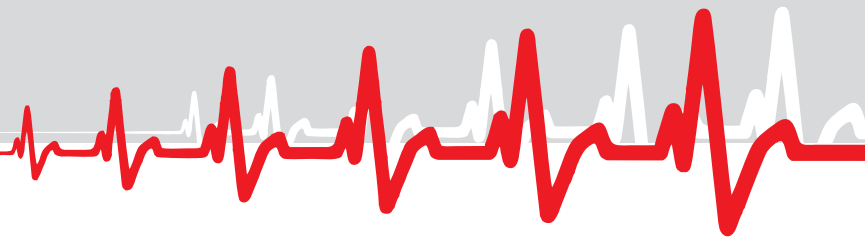

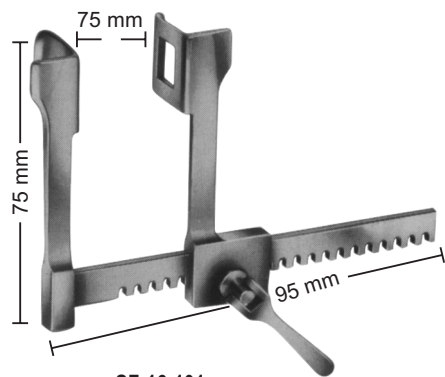

SF-16-101
FINOCHIETTO
for children
18X21 mm

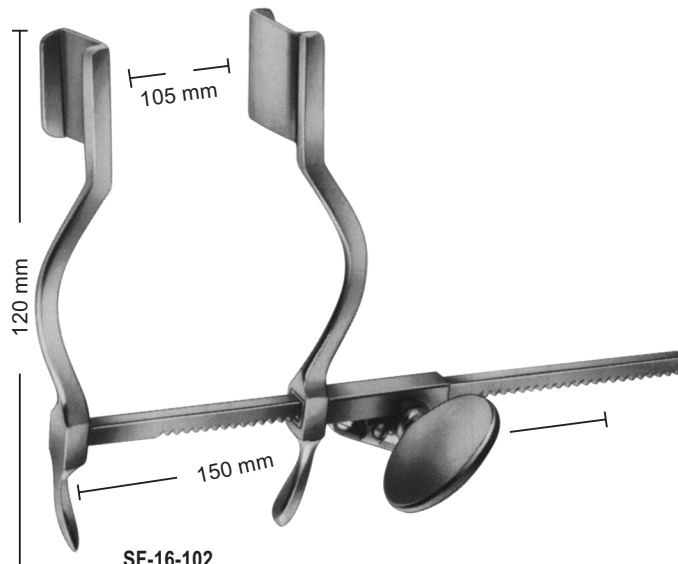

SF-16-102
HERTZLER
for children
20X25 mm

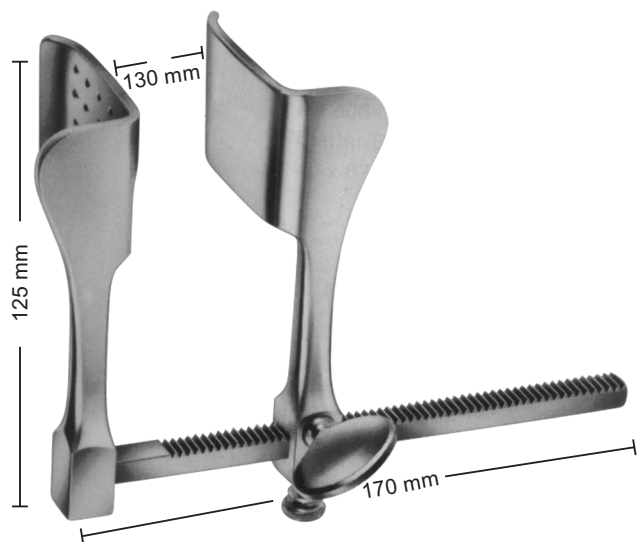

SF-16-103
TUFFIER
Blades
43X53 mm

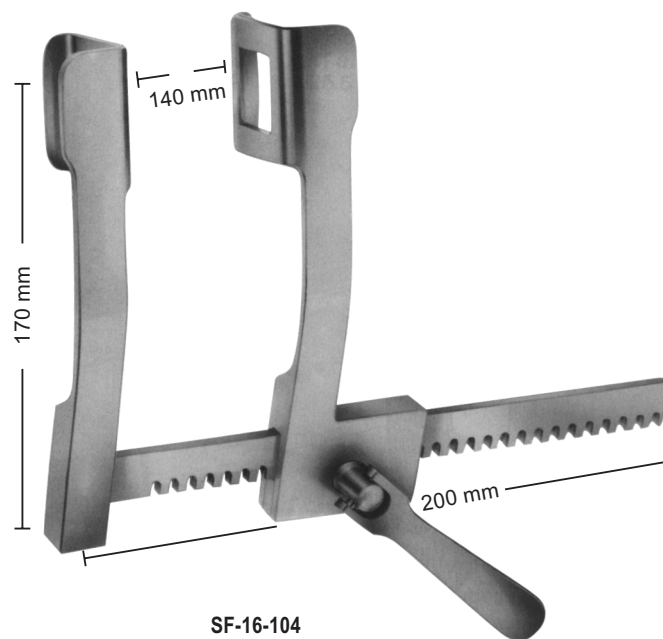

SF-16-104
FINOCHIETTO
Blades
36X45 mm

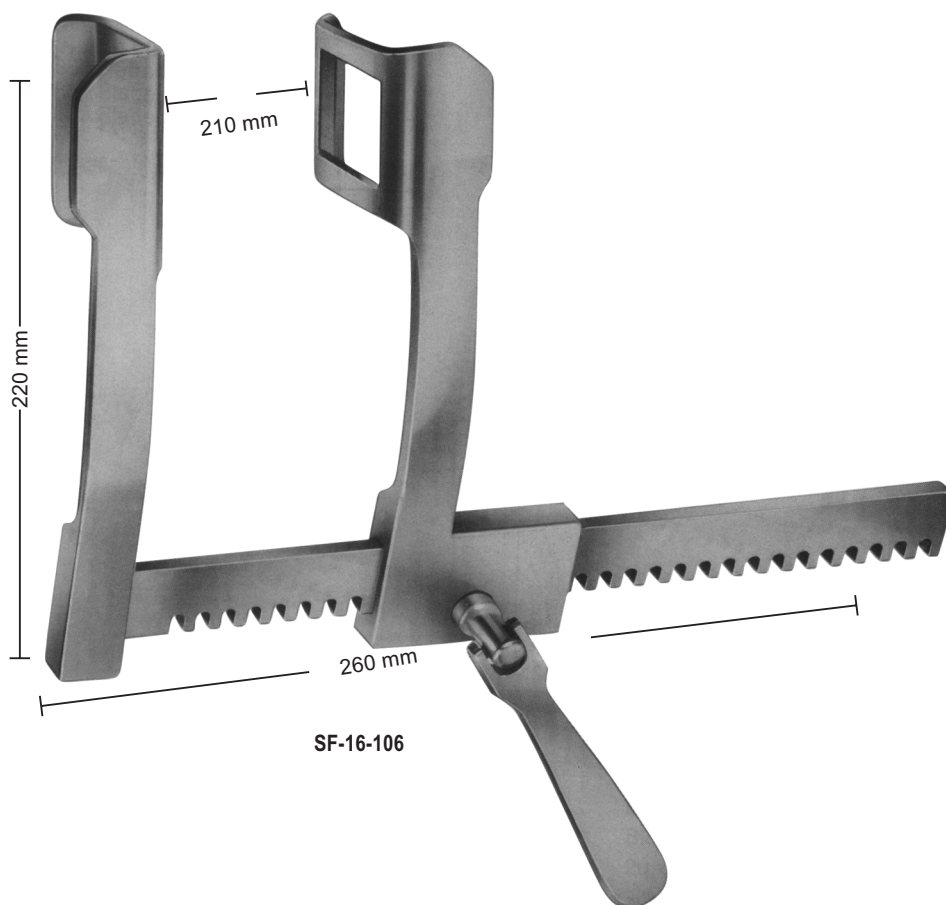
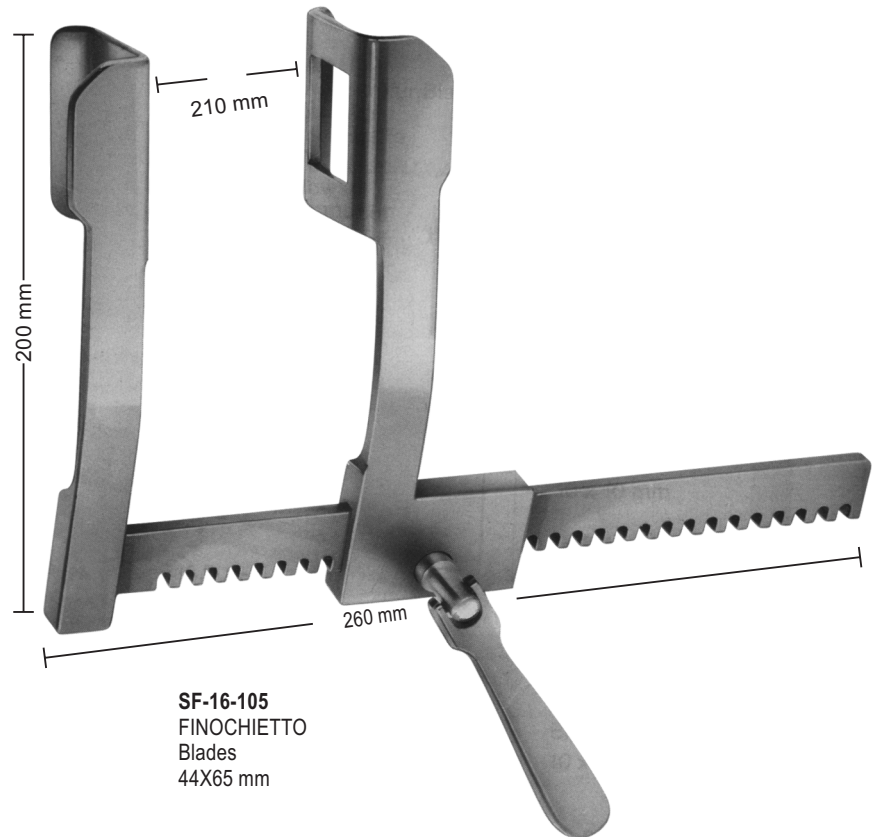

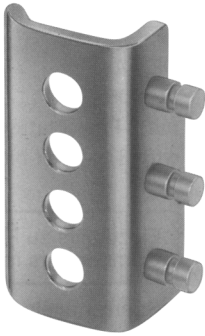

SF-16-107
Blades
46x67 mm

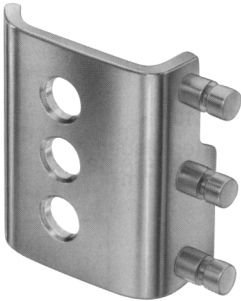

SF-16-108
Blades
80x67 mm



SF-16-109
Blades
46x67 mm

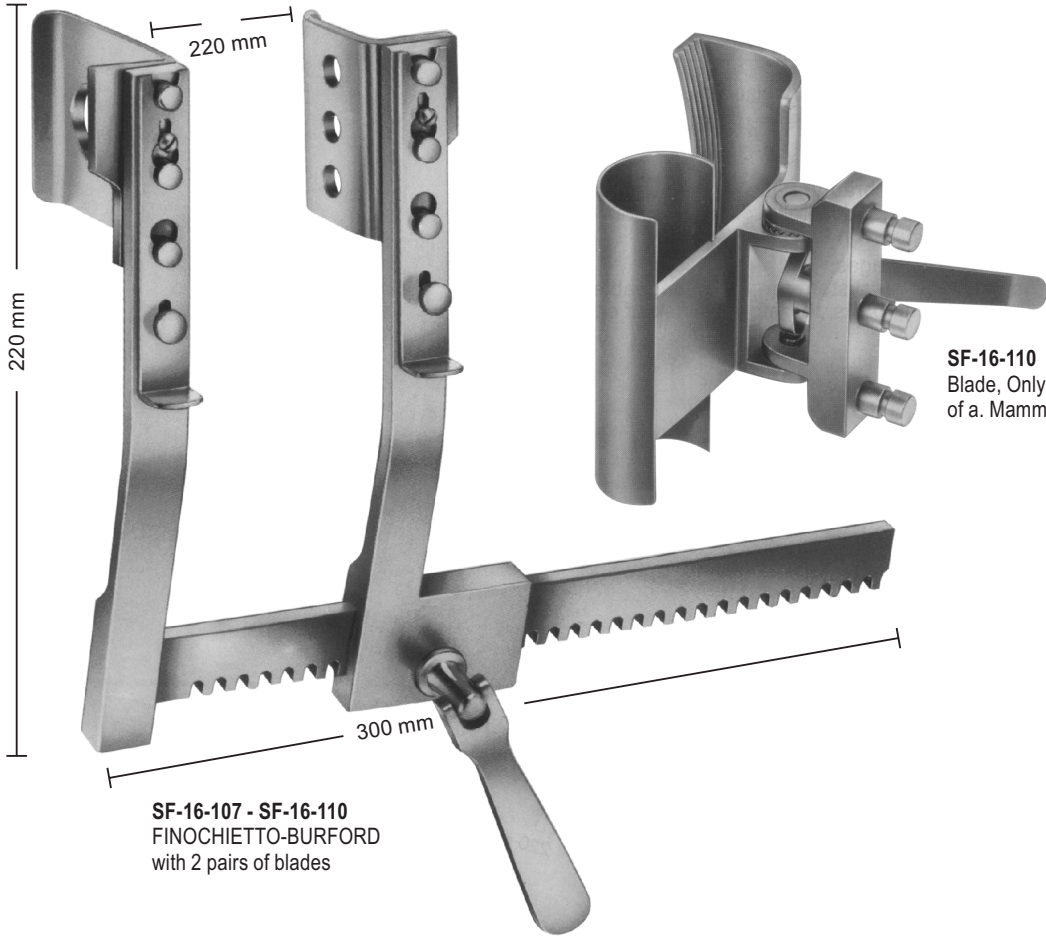
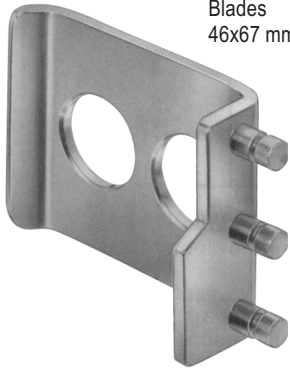
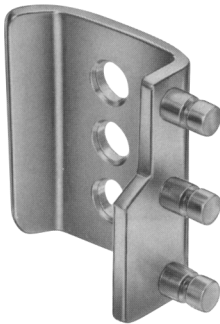
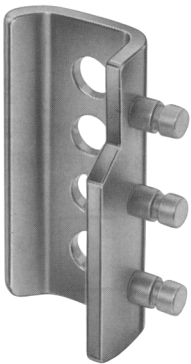

SF-16-110
Blade, Only, for preparation
of a. Mammaria, 25.5x80mm

SF-16-107 - SF-16-110
FINOCHIETTO-BURFORD
with 2 pairs of blades

RIB SPREADERS

www.surgiforce.com

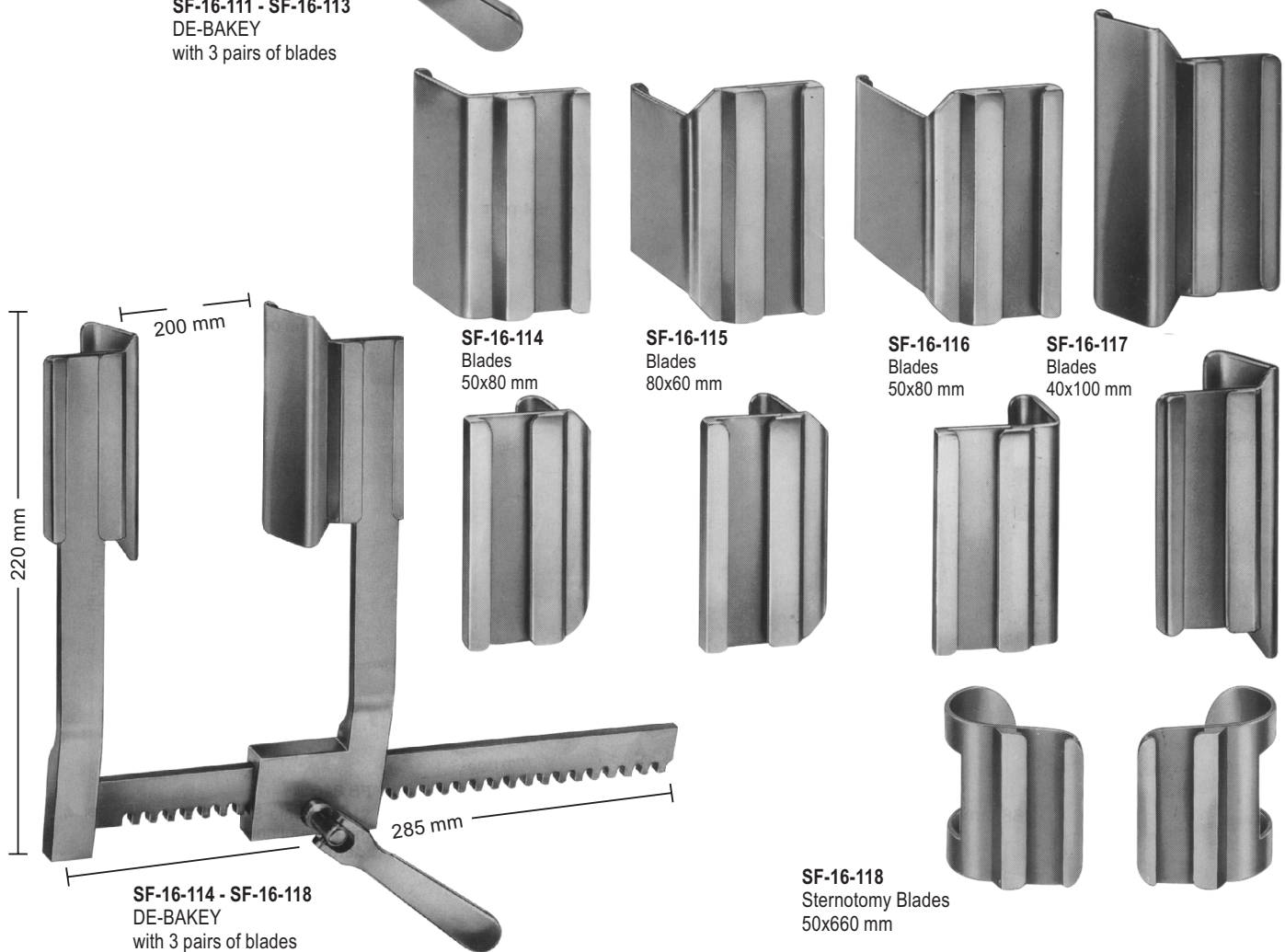
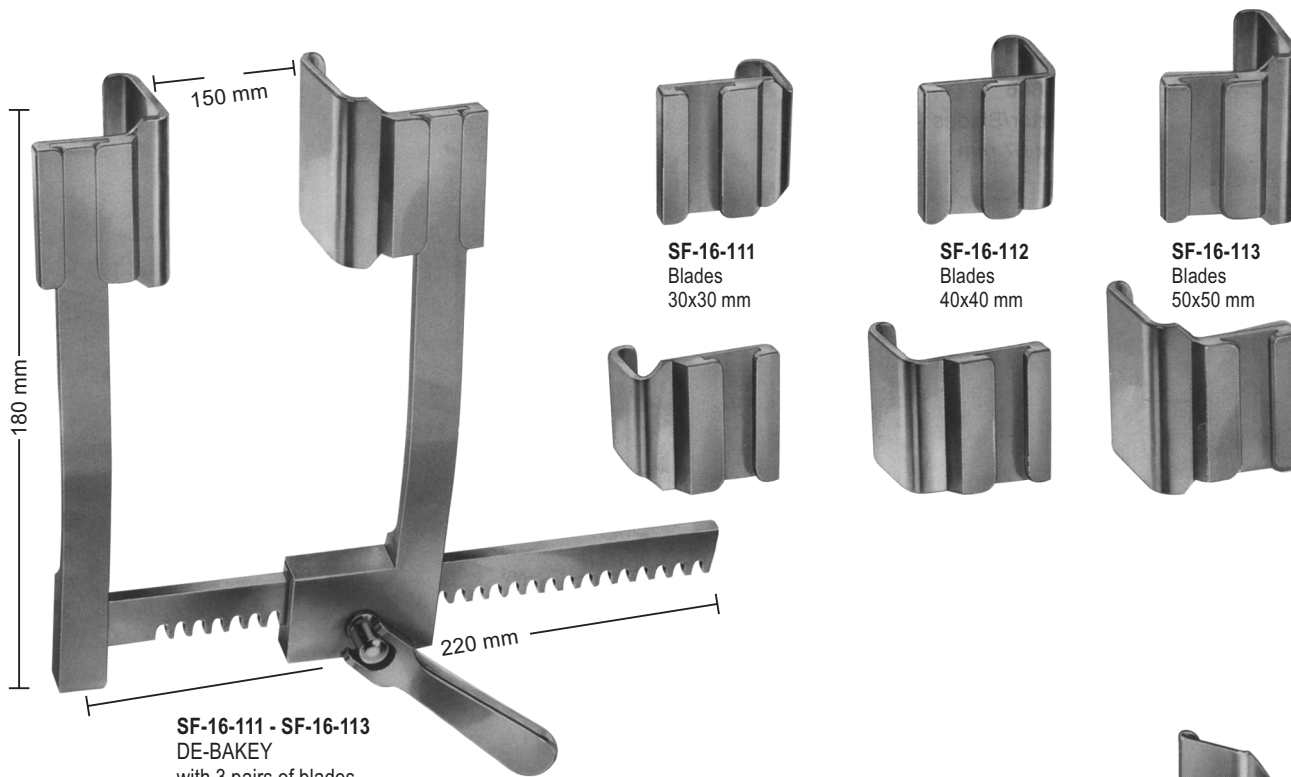

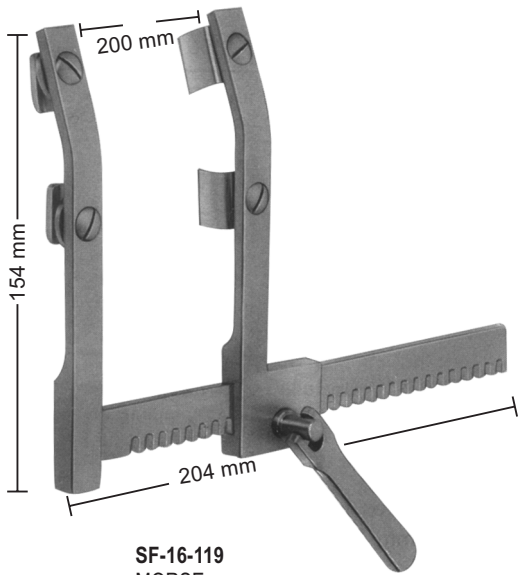

SF-16-119
MORSE
Sternotomy spreader
for children, with moveable
double, each blade
12x20 mm

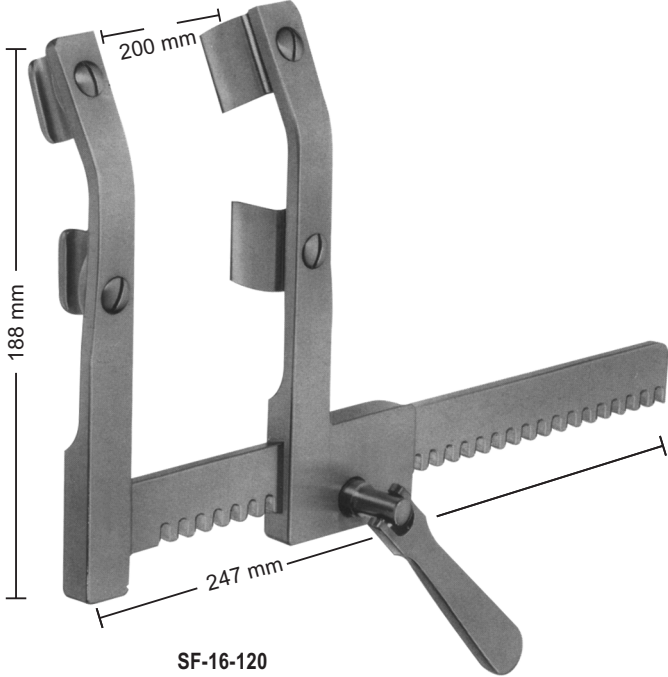

SF-16-120
MORSE
Sternotomy spreader
for adults, with moveable
double, each blade
19x19 mm

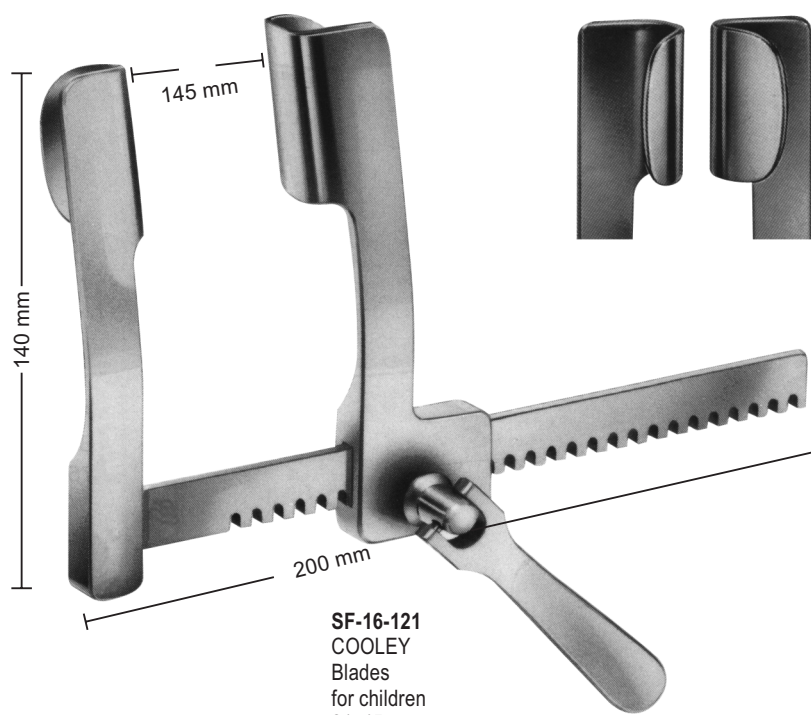

SF-16-121
COOLEY
Blades
for children
21x45mm

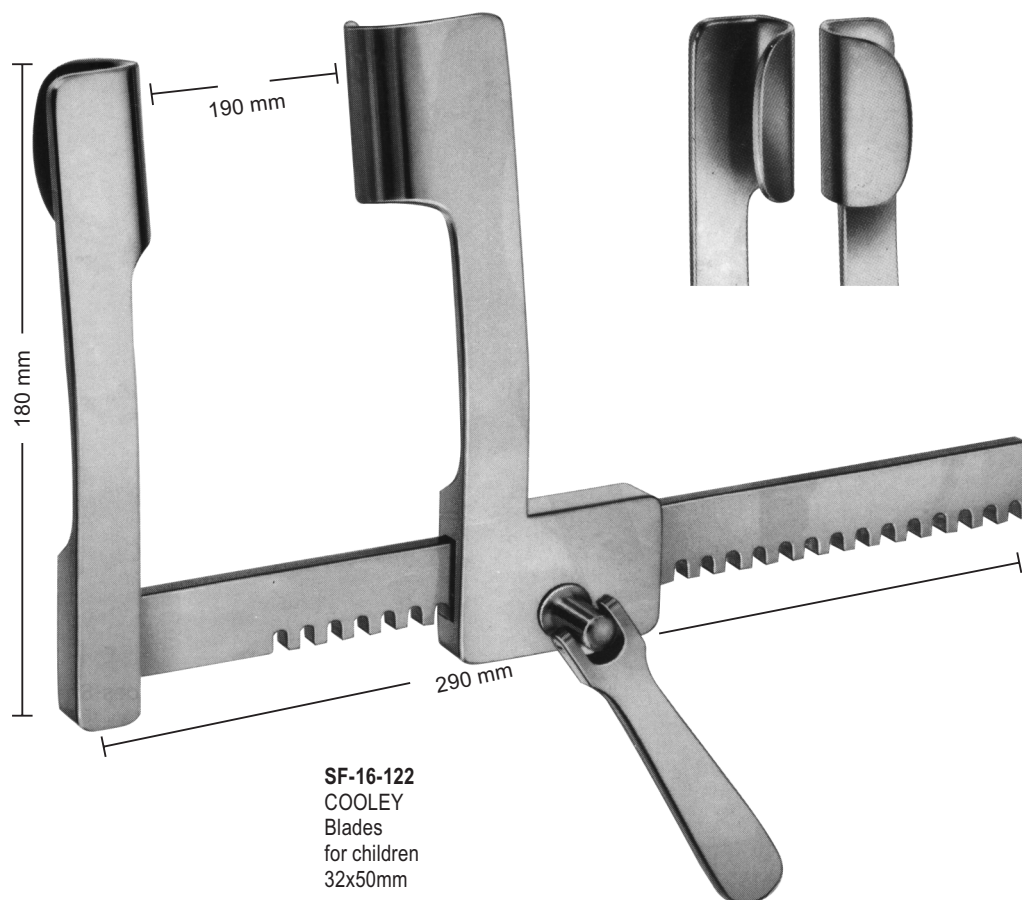

SF-16-122
COOLEY
Blades
for children
32x50mm

STAINLESS STEEL

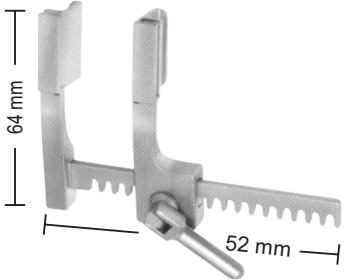

SF-16-123 - SF-16-124
for blades, with 2 pairs of blades
9X20 mm 9X10 mm, spreading 52 mm

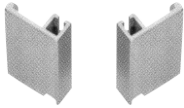

SF-16-123
Blades, only
9x20 mm



SF-16-124
Blades, only
9x10 mm

ALUMINIUM

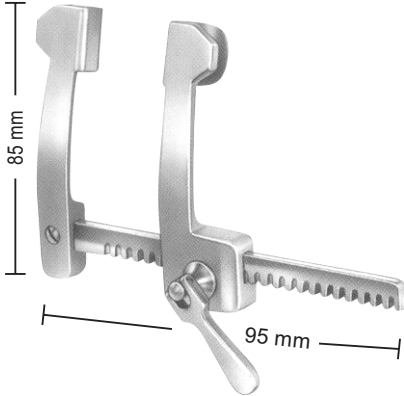

COOLEY SF-16-125
for blades, lateral blades 12X16 mm,
spreading 95 mm

ALUMINIUM

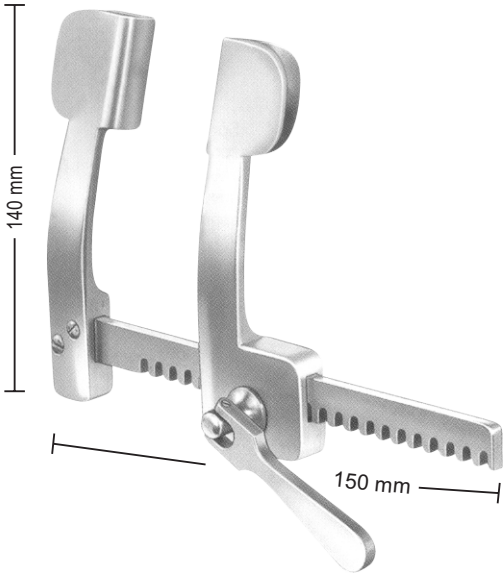

COOLEY SF-16-126
for children, lateral blades 21X44 mm,
spreading 150 mm

ALUMINIUM

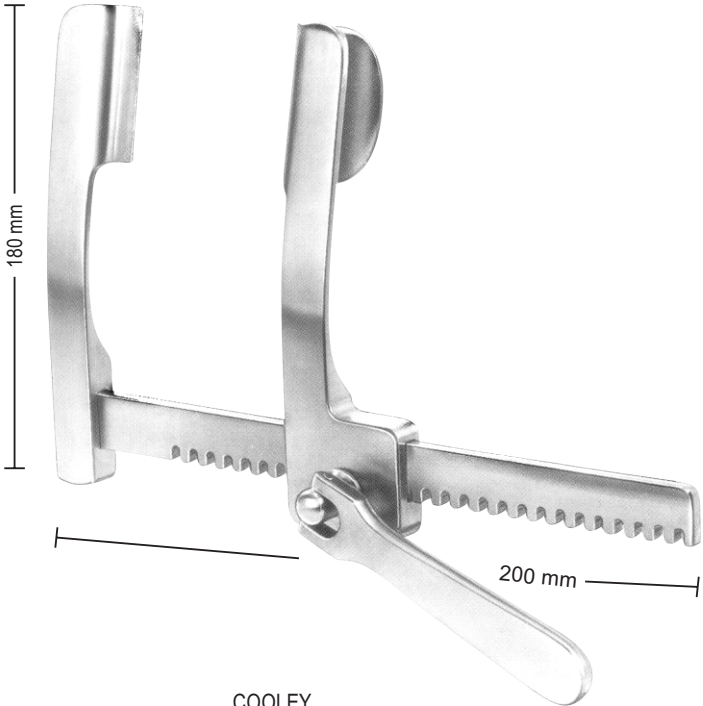

COOLEY SF-16-127
for adults, lateral blades 35X50 mm,
spreading 200 mm

ALUMINIUM

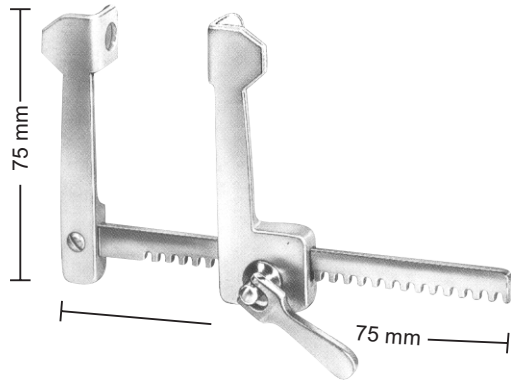

FINOCHIETTO, INFANT
SF-16-128
for children, lateral blades 15X15 mm,
spreading 75 mm

STAINLESS STEEL

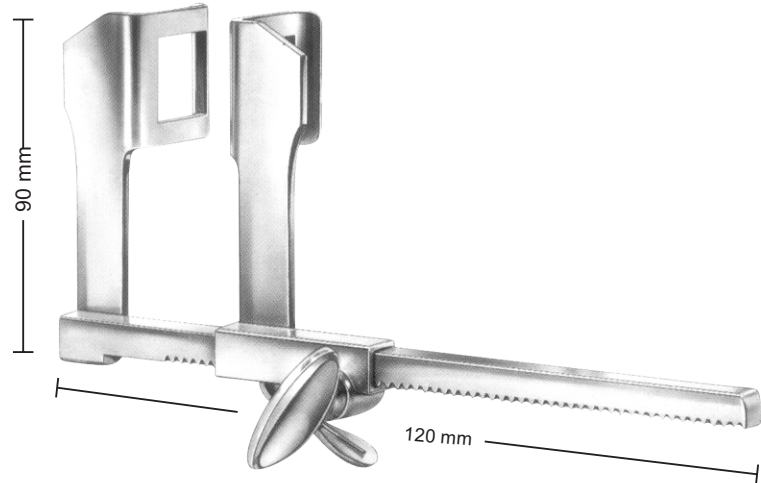

HAIGHT
SF-16-129
lateral blades 30X30 mm,
spreading 120 mm

ALUMINIUM

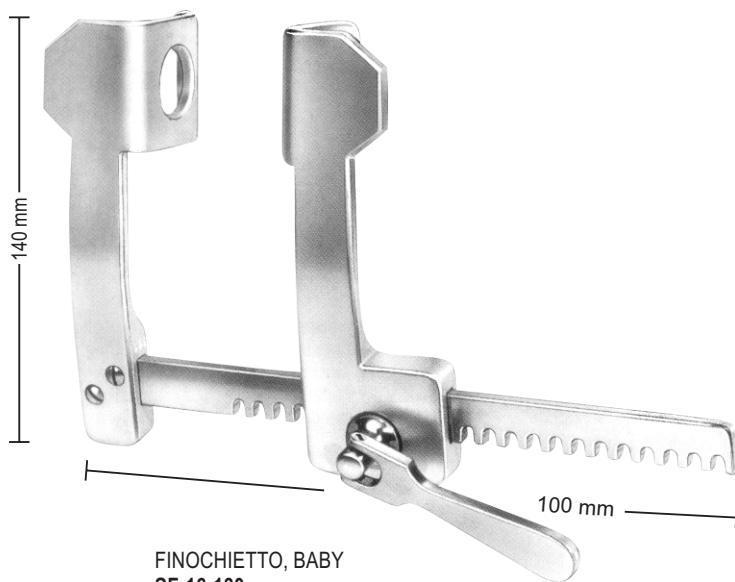

FINOCHIETTO, BABY
SF-16-130
for children, lateral blades 31X31 mm,
spreading 100 mm

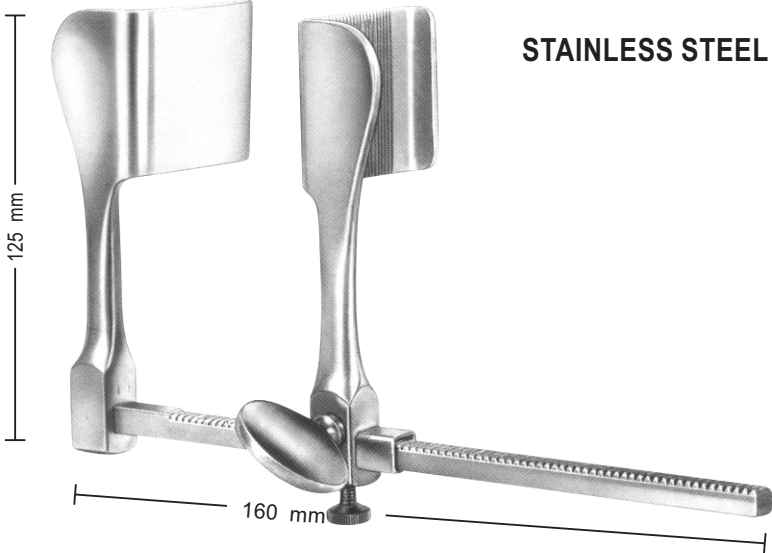

STAINLESS STEEL

TUFFIER
SF-16-131
lateral blades 45X45 mm,
spreading 160 mm

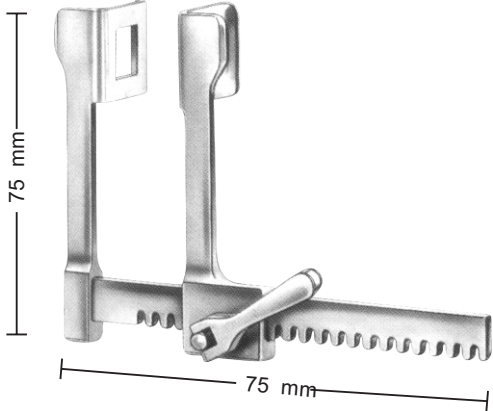

STAINLESS STEEL

FINOCHIETTO, BABY
SF-16-132
lateral blades 14X15 mm,
spreading 75 mm



STAINLESS STEEL

FINOCHIETTO
SF-16-133
lateral blades 30X45 mm, 46X62 mm, 80X65 mm,
spreading 150 mm, 190 mm, 190 mm



SF-16-135
Blades
75x75 mm

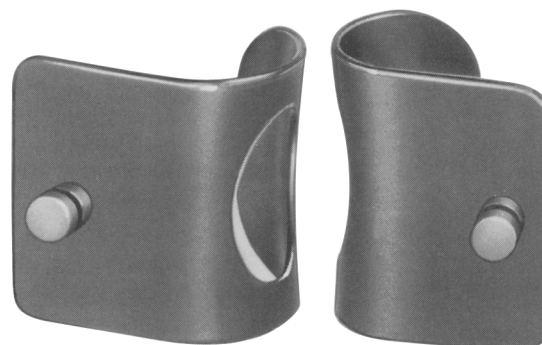

SF-16-136
Blades
42x65 mm



Blades with Ball Snap System
Delivery: in Pairs

- SF-16-134 - SF-16-136**
Thoraxsperrer (Mercedes-Sperrer)
complete consisting of:
SF-16-134 Retractor only
SF-16-135 1 Pair of blades 42x65 mm
SF-16-136 1 Pair of blades 75x75 mm

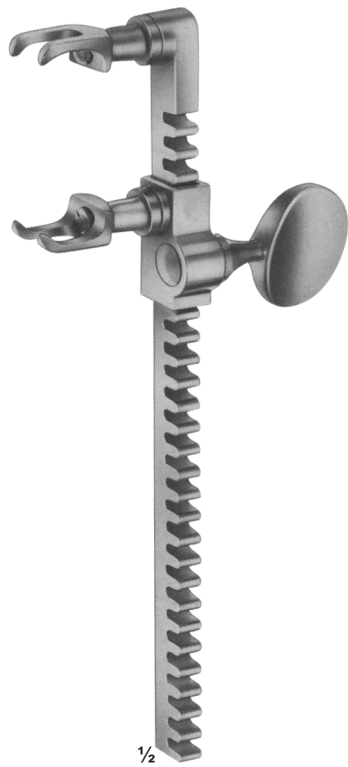

SF-16-137
SELLORS
Rib spreader and contractor
with swivel blades
200 mm



SF-16-138
BAILEY
150 mm



SF-16-139
for children

SF-16-140
for children

SF-16-139 - SF-16-141
BAILEY
200 mm

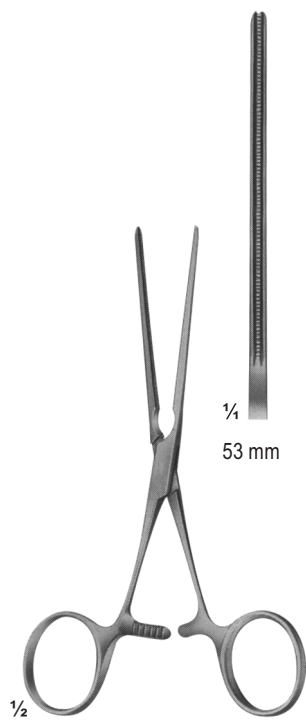

SF-16-142
DE-BAKEY
gerade straight
130 mm

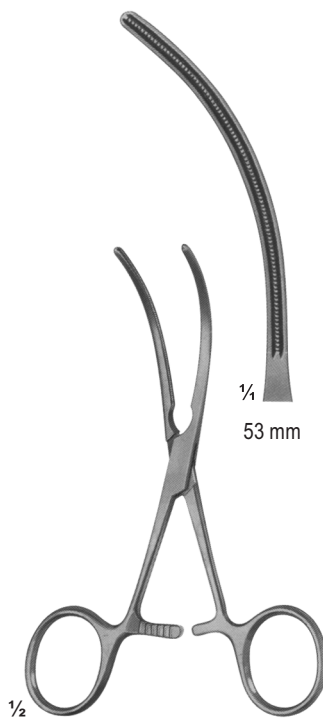

SF-16-143
DE-BAKEY
Maul gebogen
curved jaws
125 mm

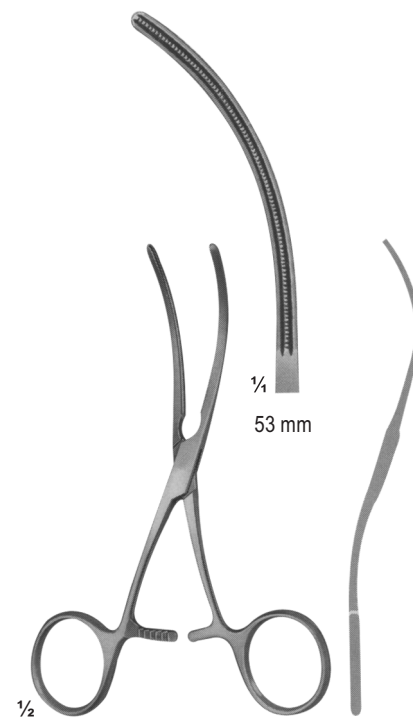

SF-16-144
DE-BAKEY
S-shaped curved
125 mm

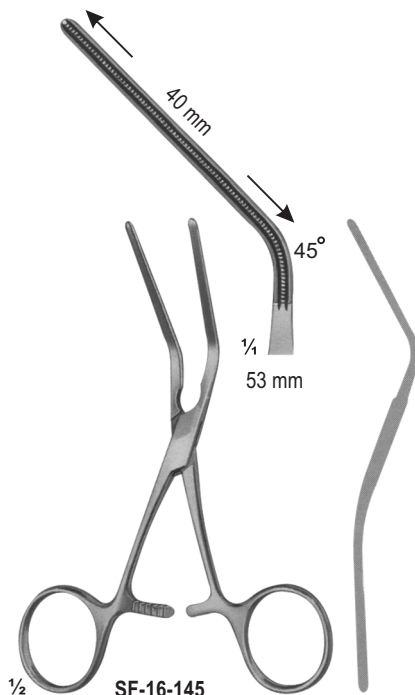

SF-16-145
DE-BAKEY
45° winklig gebogen
angled 45°
125 mm

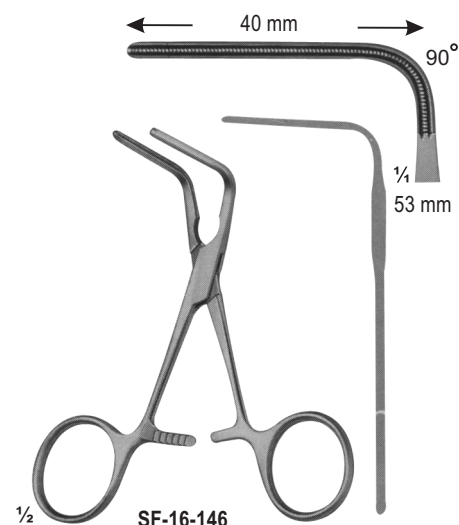

SF-16-146
DE-BAKEY
90° winklig gebogen
angled 90°
105 mm



SF-16-147 - SF-16-150
CASTANESA

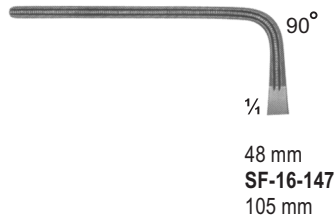

48 mm
SF-16-147
105 mm

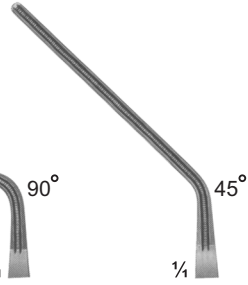

48 mm
SF-16-148
120 mm

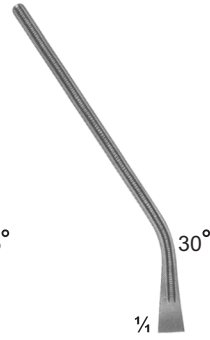

48 mm
SF-16-149
120 mm



48 mm
SF-16-150
125 mm



SF-16-151 - SF-16-154
CASTANESA

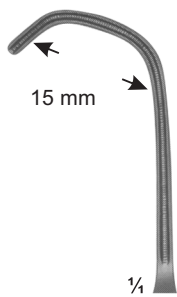

48 mm
SF-16-151
155 mm

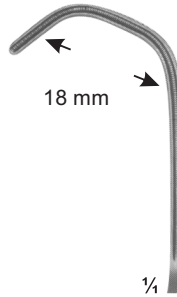

52 mm
SF-16-152
150 mm

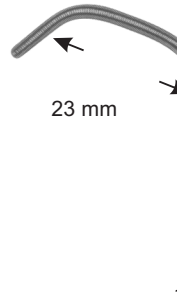

56 mm
SF-16-153
150 mm

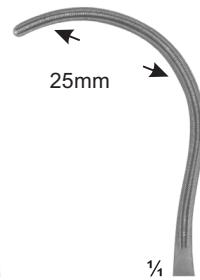

50 mm
SF-16-154
155 mm

ANASTOMOSIS AND MULTI-PURPOSE-CLAMPS-PEDIATRIC TYPES

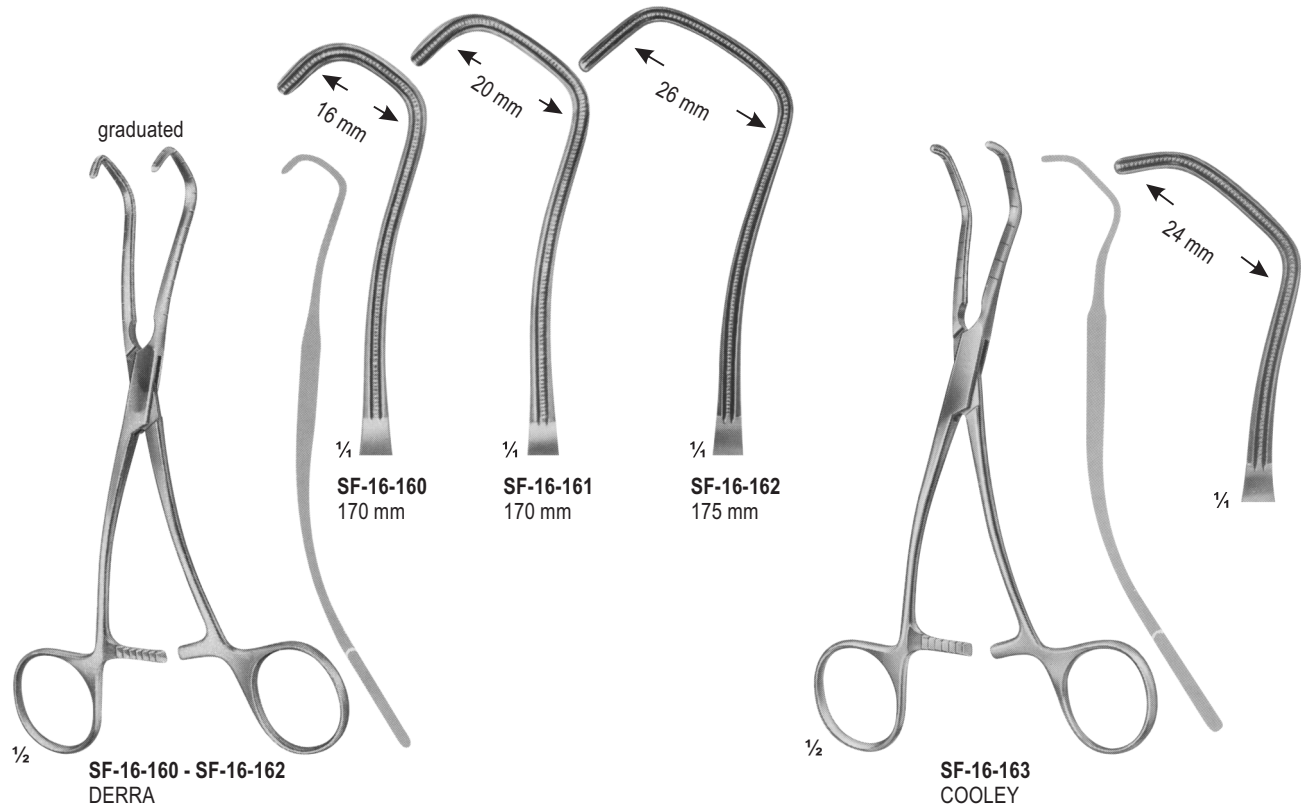
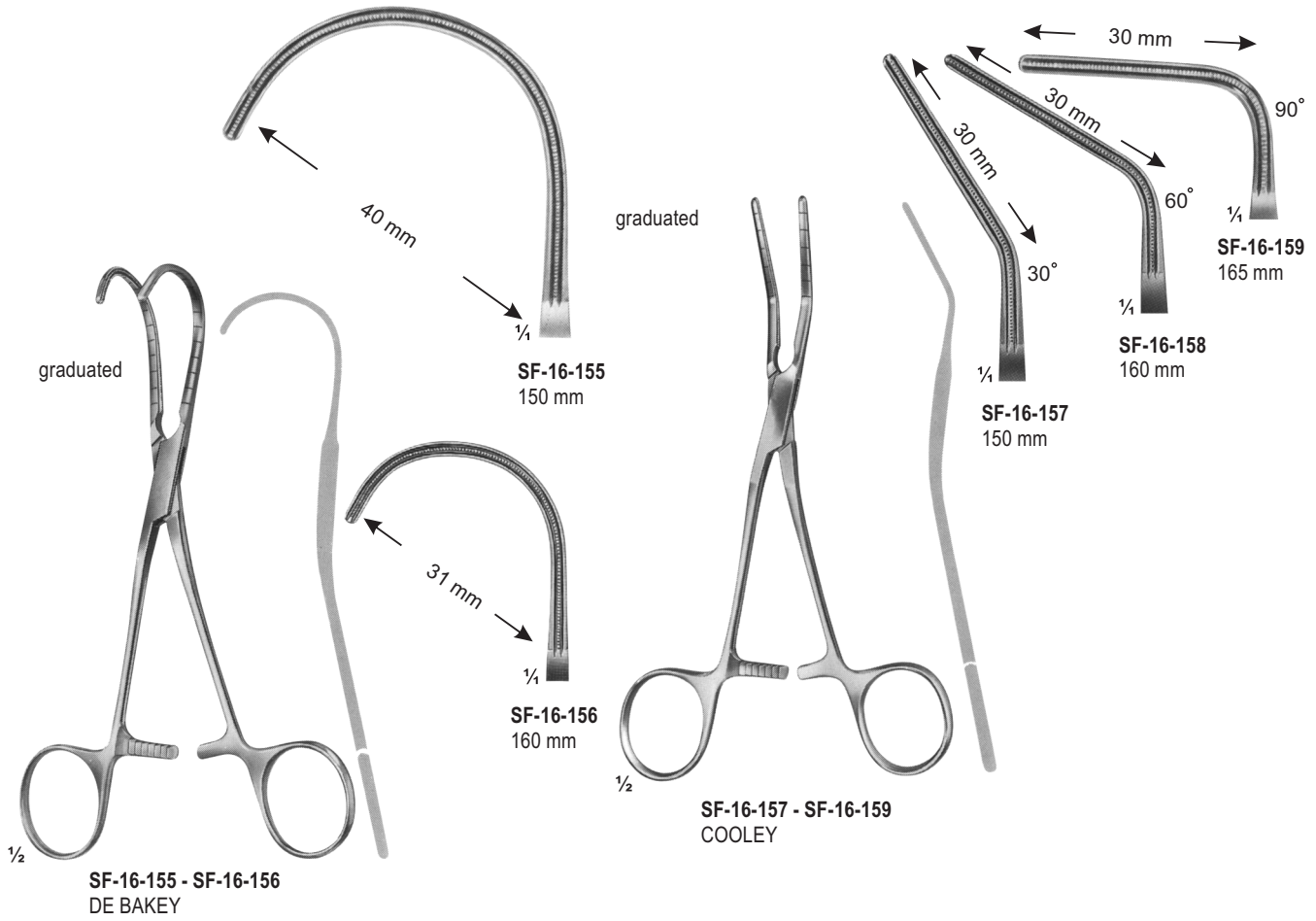

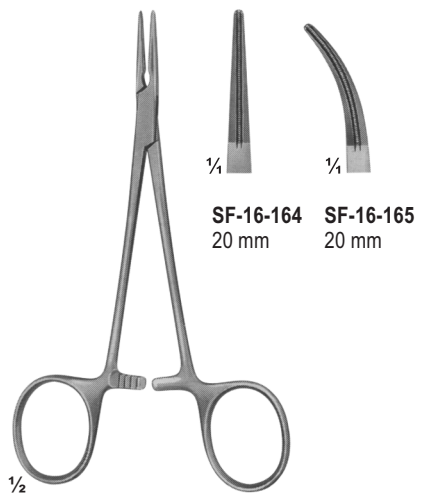

SF-16-164 20 mm
SF-16-165 20 mm

SF-16-164 - SF-16-165
HALSTED
125 mm

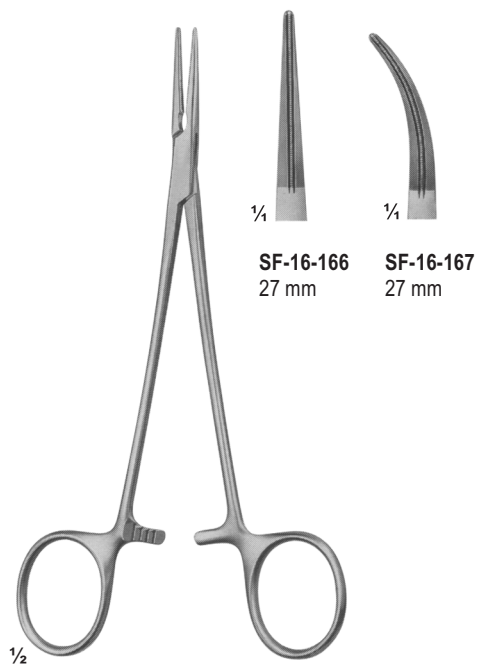

SF-16-166 27 mm
SF-16-167 27 mm

SF-16-166 - SF-16-167
RANKIN
165 mm

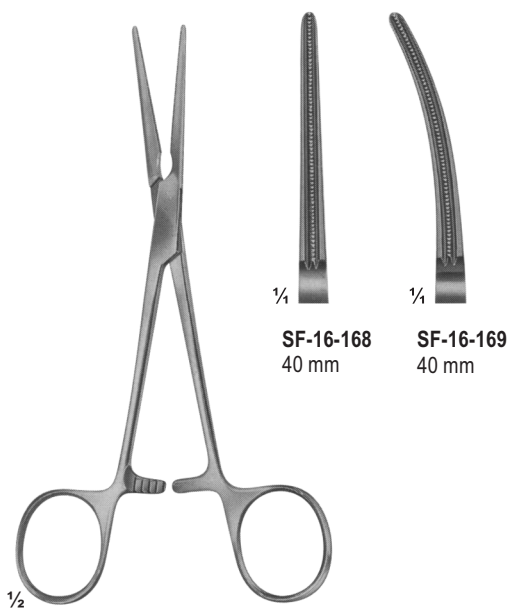

SF-16-168 40 mm
SF-16-169 40 mm

SF-16-168 - SF-16-169
DE BAKEY-BAINRIDGE
155 mm

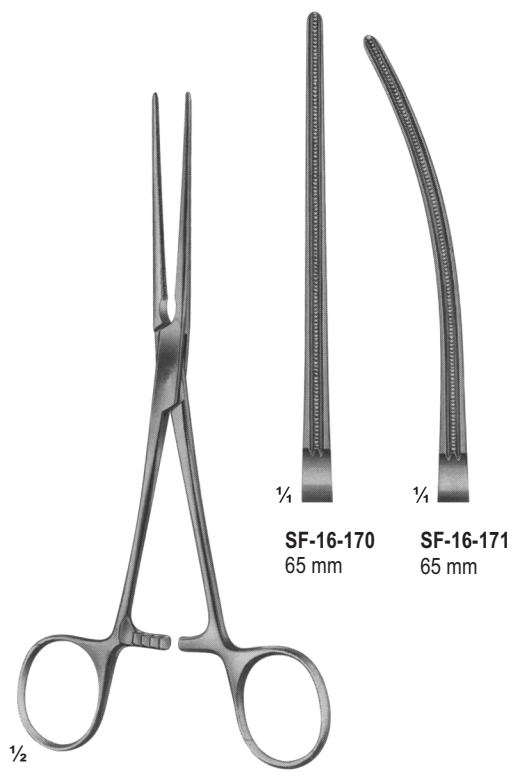

SF-16-170 65 mm
SF-16-171 65 mm

SF-16-170 - SF-16-171
DE BAKEY-BAINRIDGE
180 mm

NON-TRAUMATIC HAEMOSTATIC FORCEPS

www.surgiforce.com

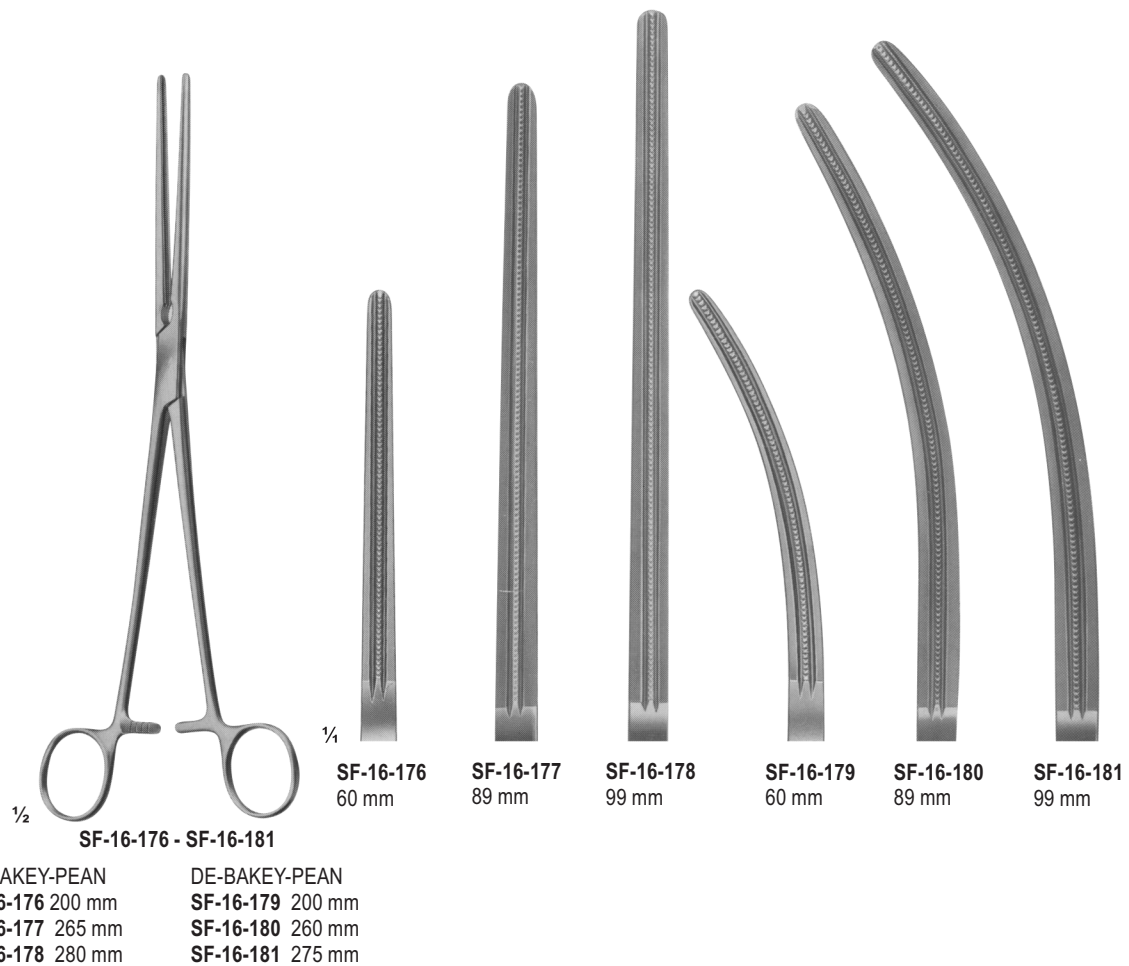
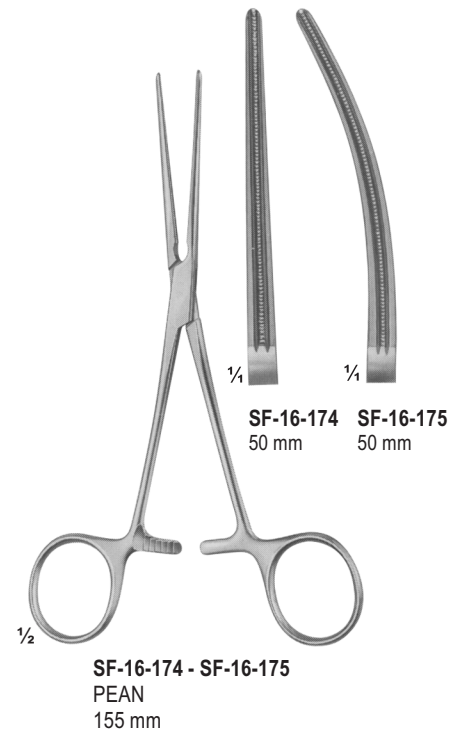
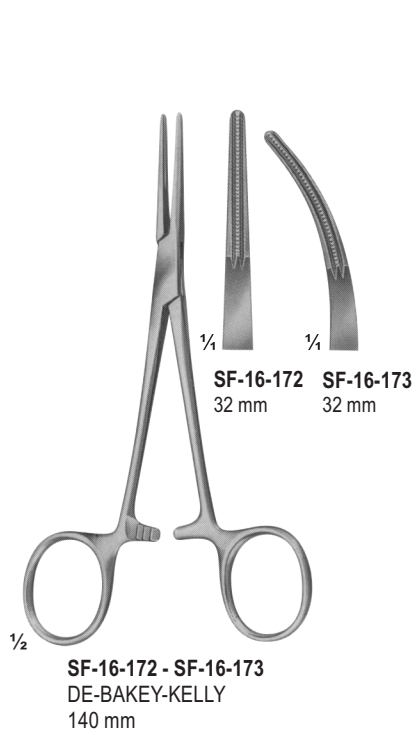

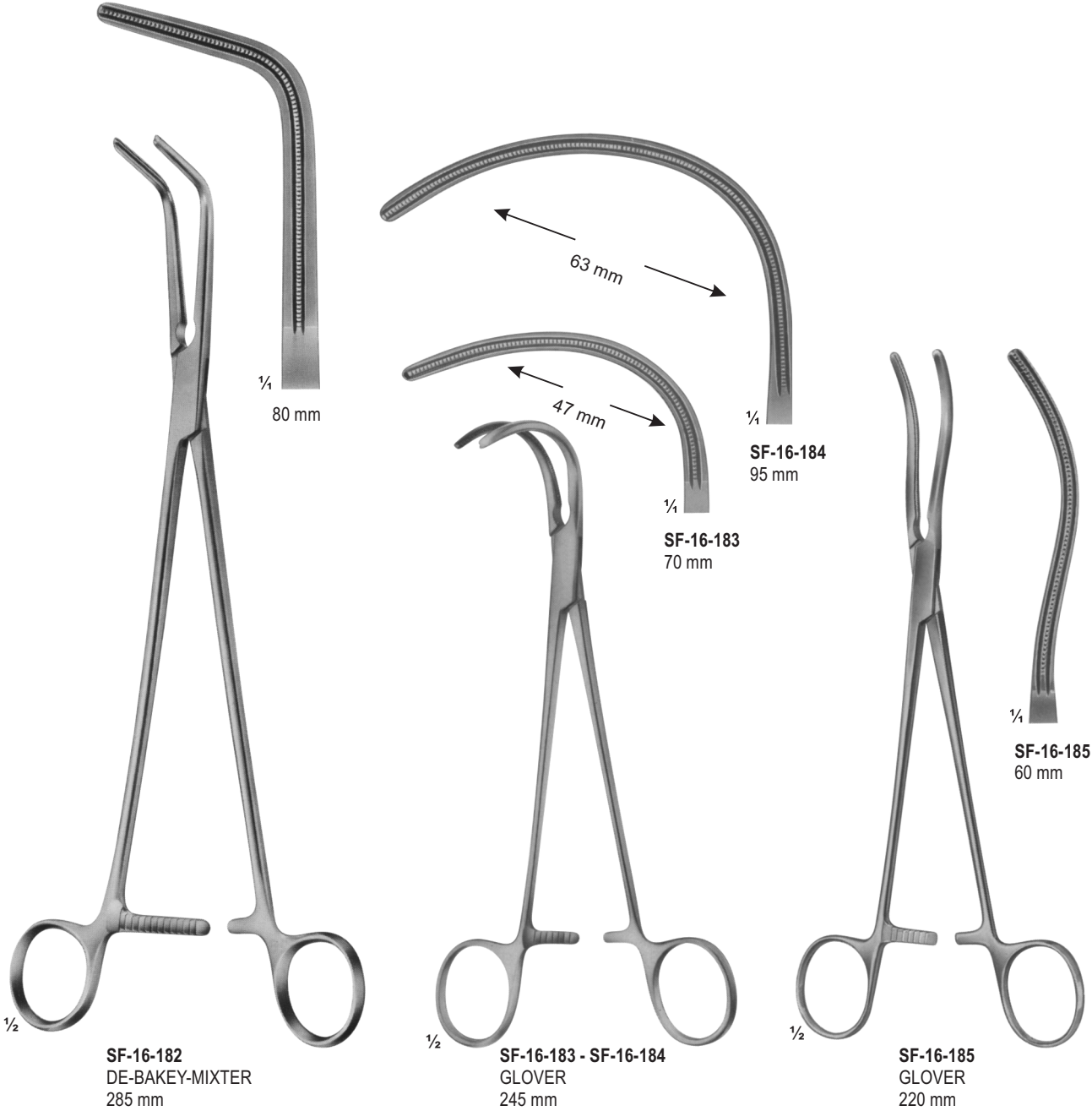

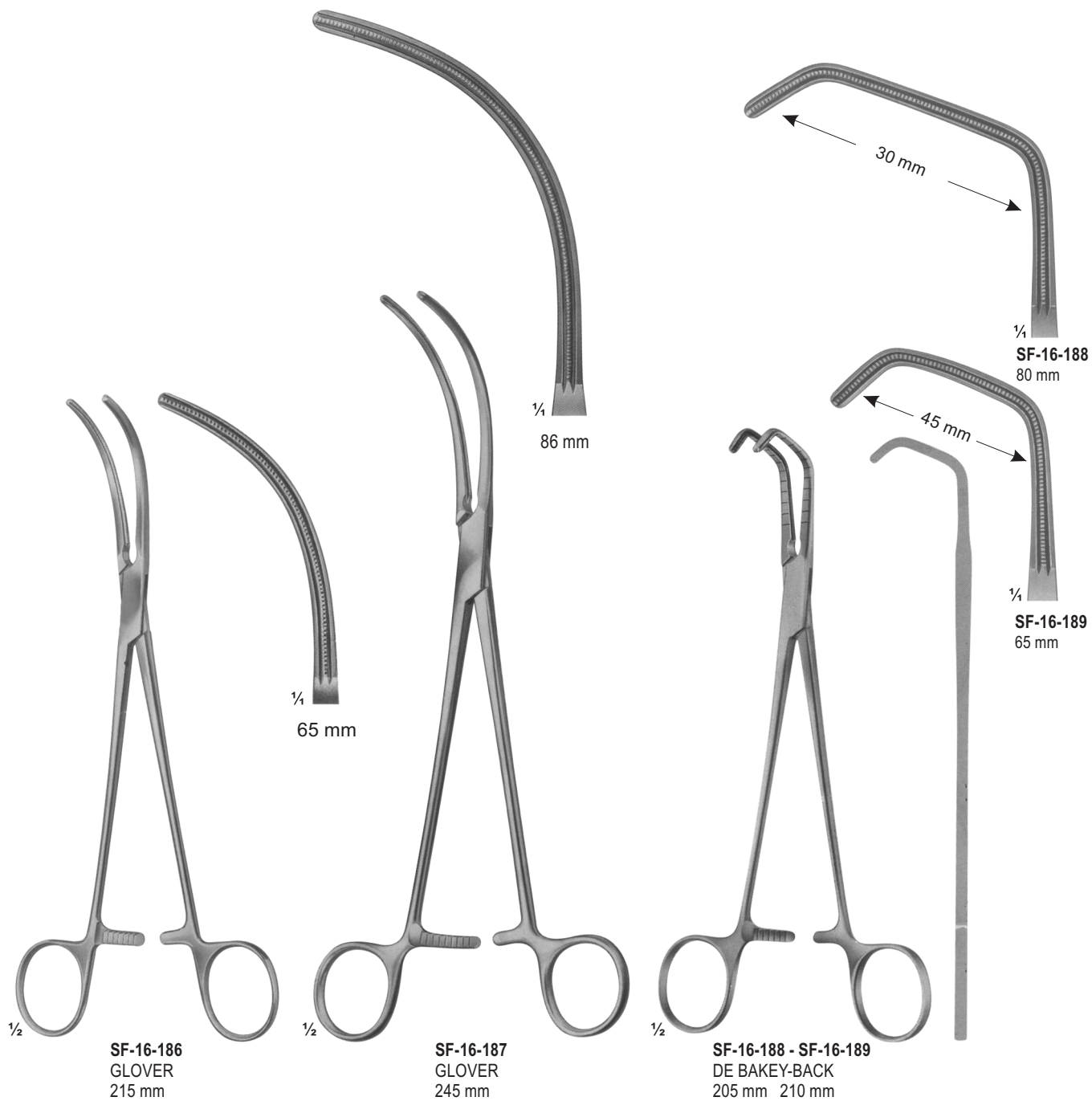



1/2

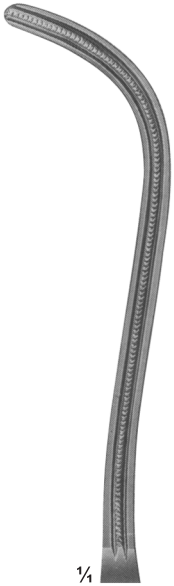

SF-16-190
86 mm

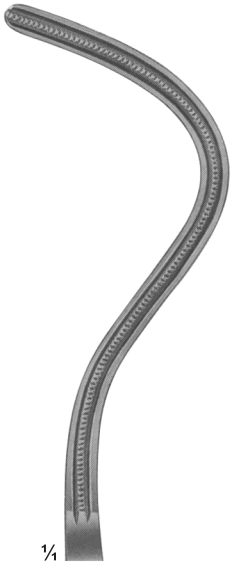

SF-16-191
86 mm

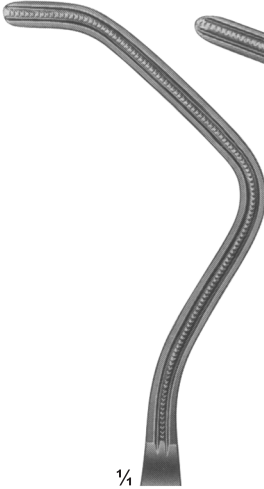

SF-16-192
86 mm

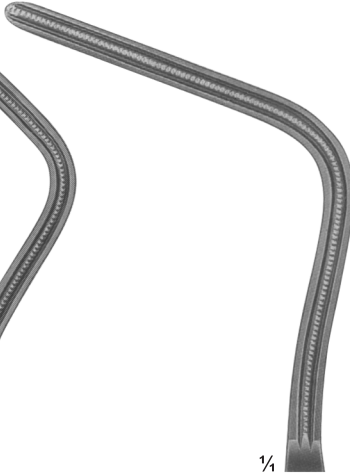

SF-16-193
86 mm

SF-16-190 - SF-16-193
DE BAKHEY-HARKEN
SF-16-190 - 255 mm
SF-16-191 - 245 mm
SF-16-192 - 245 mm
SF-16-193 - 245 mm



1/2

SF-16-194 - SF-16-198
DE BAKHEY

Total Length:
Length of jaws:

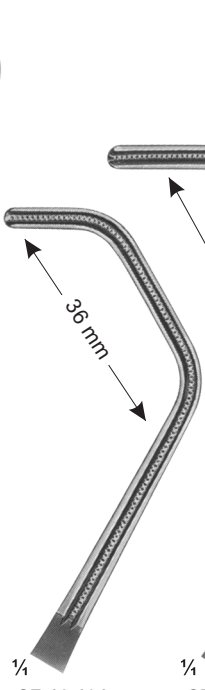

SF-16-194
220 mm
85 mm

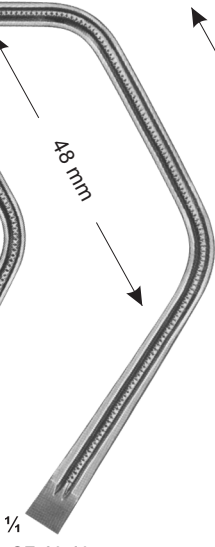

SF-16-195
256 mm
95 mm

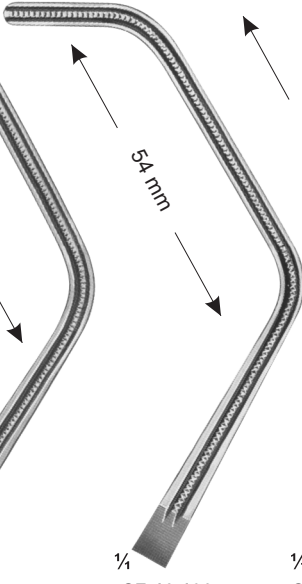

SF-16-196
270 mm
99 mm

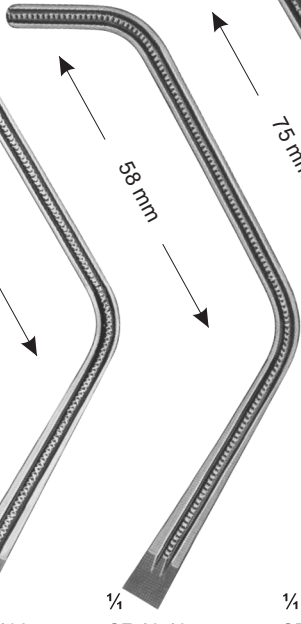

SF-16-197
270 mm
103 mm

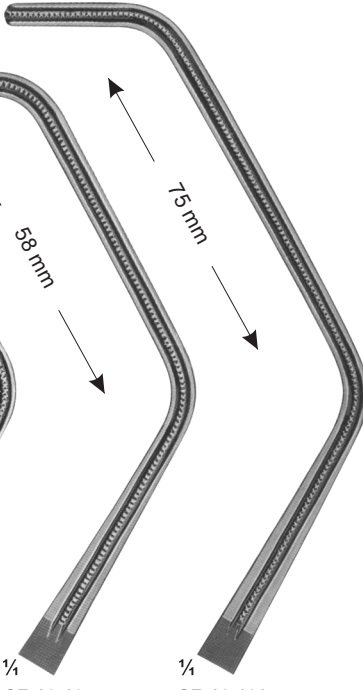

SF-16-198
280 mm
119 mm

NON-TRAUMATIC HAEMOSTATIC FORCEPS

www.surgiforce.com



1/2

DE-BAKEY-KELLY
SF-16-199 - SF-16-200
140 mm



1/4

SF-16-199
32 mm



1/4

SF-16-200
32 mm



1/2

PEAN
SF-16-201 - SF-16-202
155 mm



1/4

SF-16-201
50 mm



1/4

SF-16-202
50 mm



1/2

SF-16-203 - SF-16-208

DE-BAKEY-PEAN	DE-BAKEY-PEAN
SF-16-203 200 mm	SF-16-206 200 mm
SF-16-204 265 mm	SF-16-207 260 mm
SF-16-205 280 mm	SF-16-208 275 mm

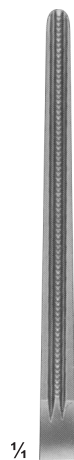

1/4

SF-16-203
60 mm

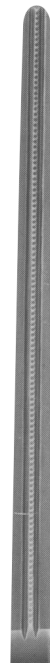

SF-16-204
89 mm



SF-16-205
99 mm

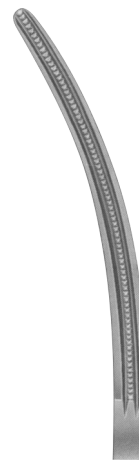

SF-16-206
60 mm

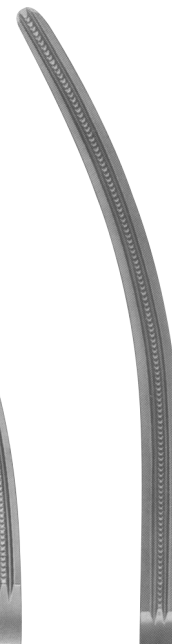

SF-16-207
89 mm



SF-16-208
99 mm



CASTANEDA
SF-16-209 - SF-16-212

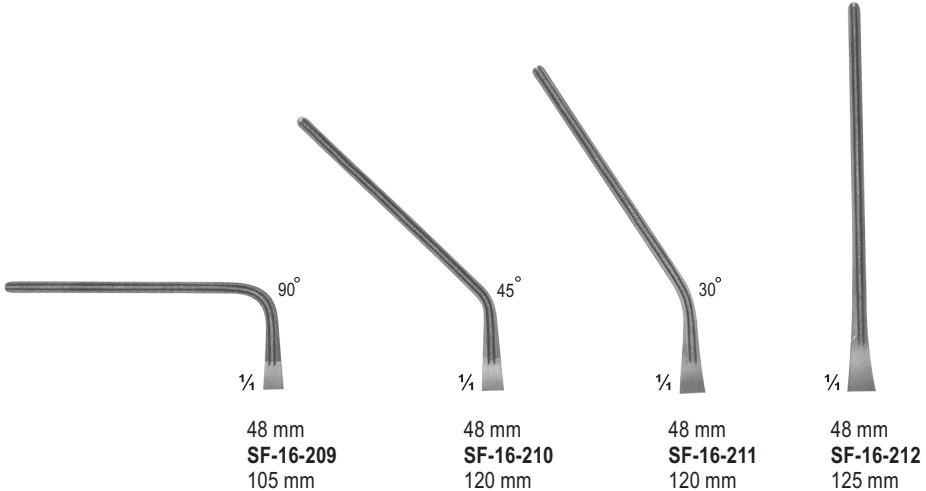

CASTANEDA
SF-16-213 - SF-16-216

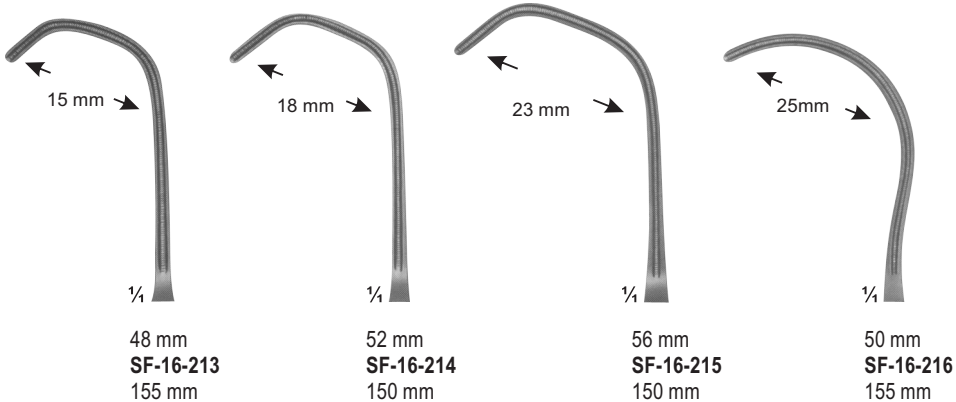

ANASTOMOSIS CLAMPS & VENA-CAVA CLAMPS

www.surgiforce.com

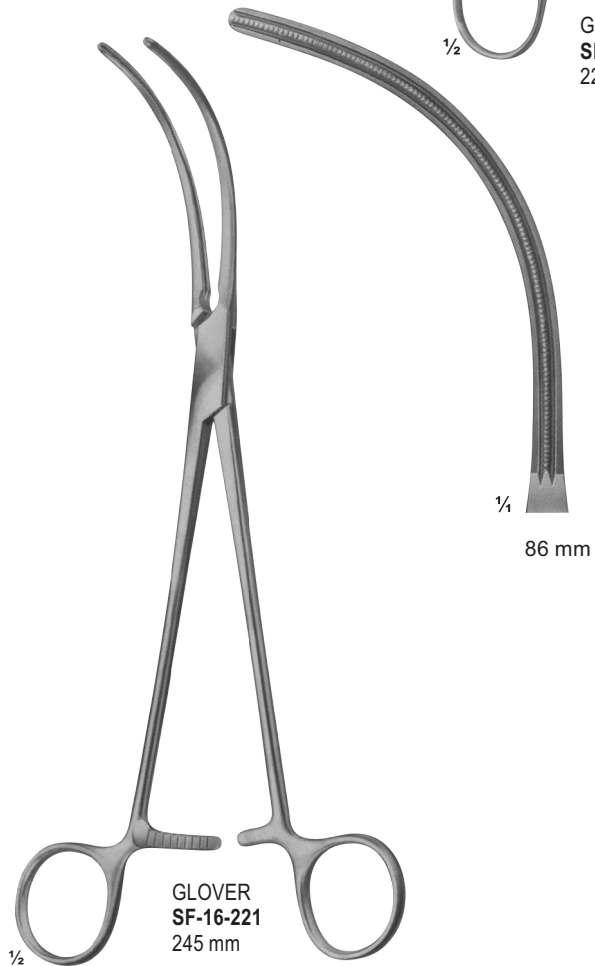
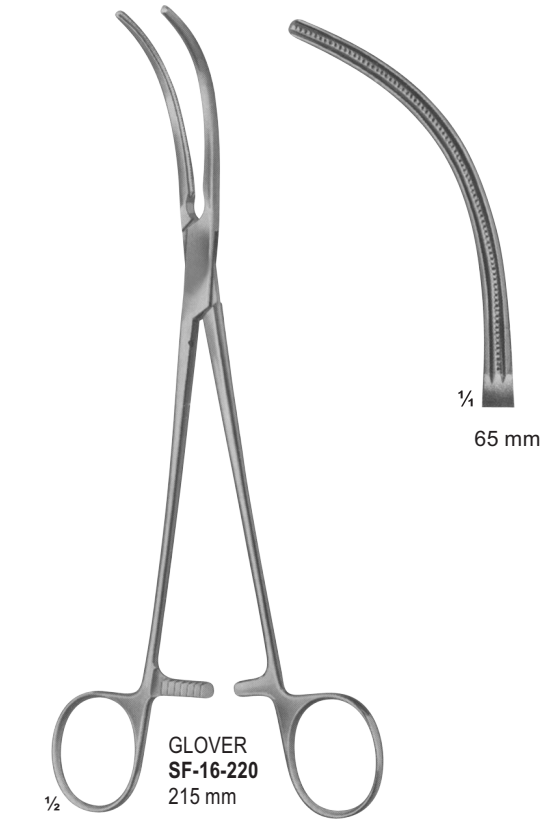
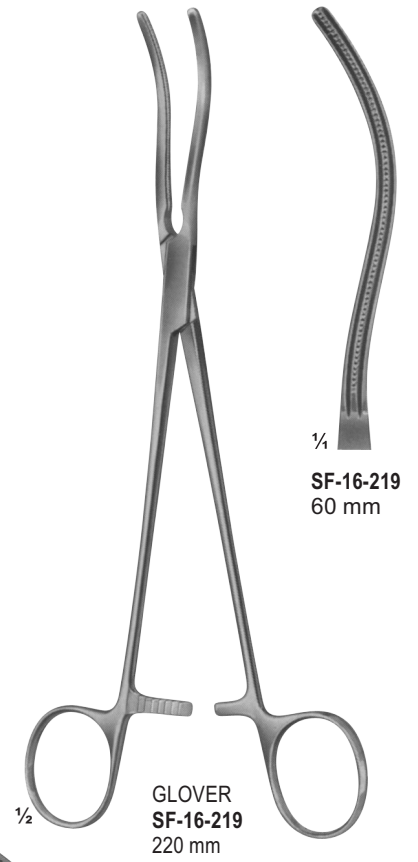
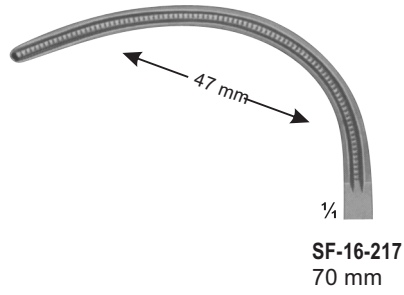
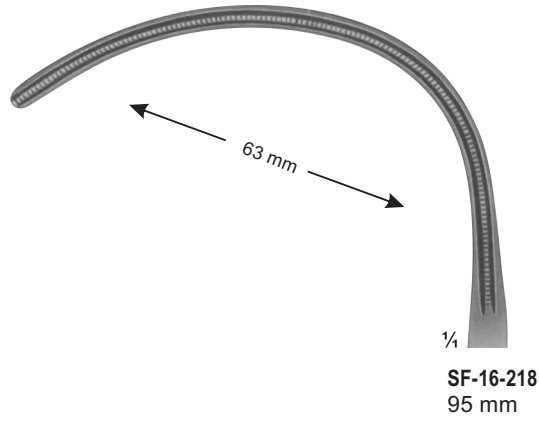



DE BAKEY-BACK
SF-16-222 20.5 cm
SF-16-223 21 cm

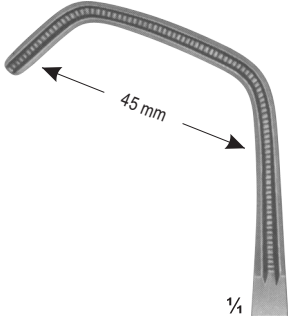

SF-16-222
65 mm

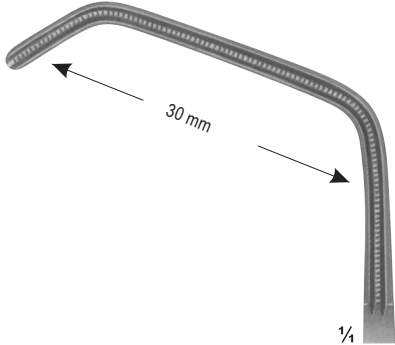

SF-16-223
80 mm



SF-16-224
86 mm

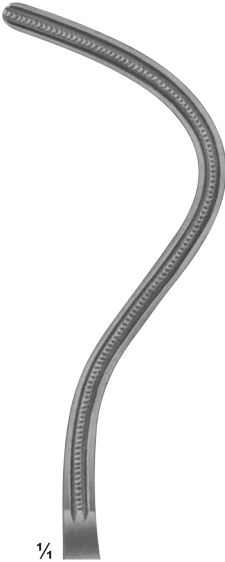

SF-16-225
86 mm

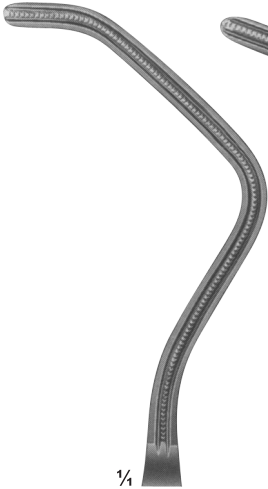

SF-16-226
86 mm

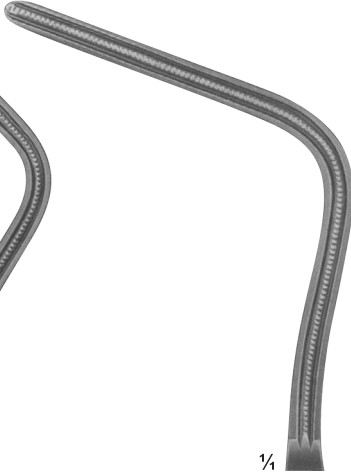

SF-16-227
86 mm



DE BAKEY-HARKEN
SF-16-224 25.5 cm
SF-16-225 24.5 cm
SF-16-226 24.5 cm
SF-16-227 24.5 cm

MULTI-PURPOSE CLAMPS

www.surgiforce.com

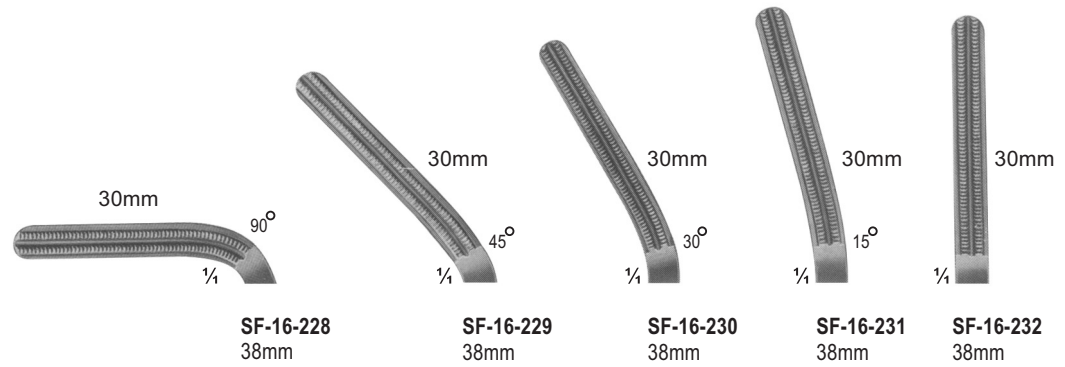

DARDIK

SF-16-228 15 cm
 SF-16-229 15 cm
 SF-16-230 15 cm
 SF-16-231 14.5 cm
 SF-16-232 13 cm

SF-16-233 17 cm
 SF-16-234 17 cm
 SF-16-235 17 cm
 SF-16-236 16 cm
 SF-16-237 13.5 cm

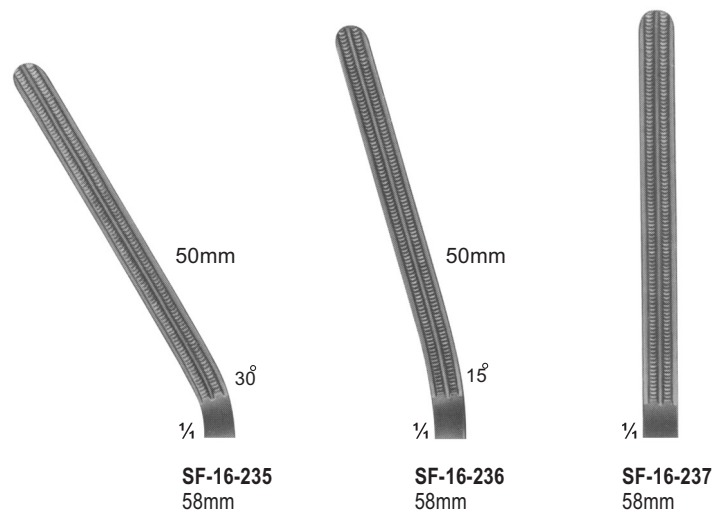
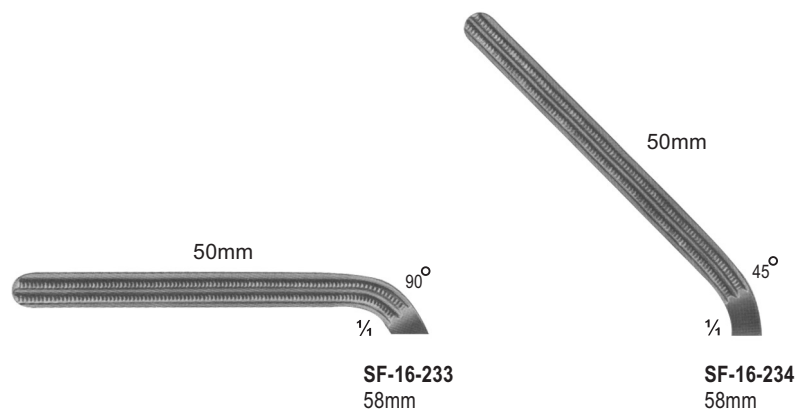

ATRAUMA

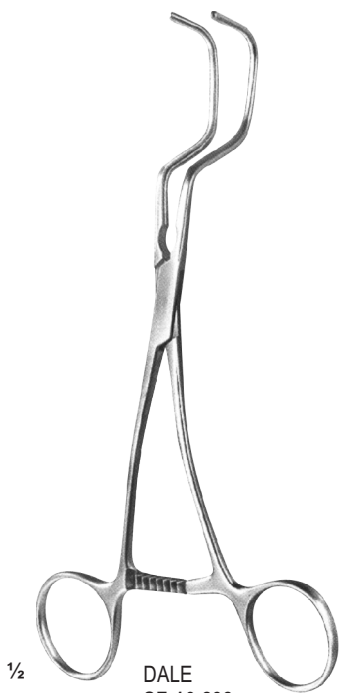

DALE
SF-16-238
180 mm

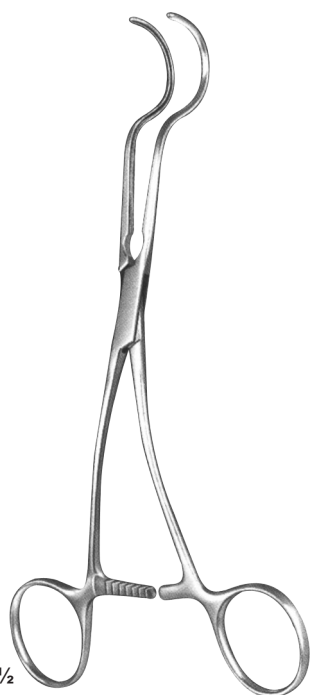
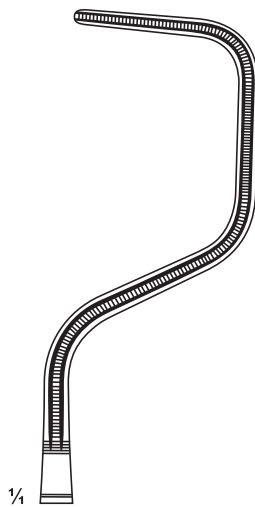

DALE
SF-16-239 - SF-16-241

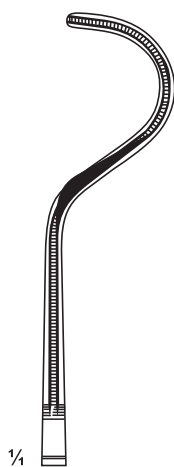

SF-16-239
175 mm

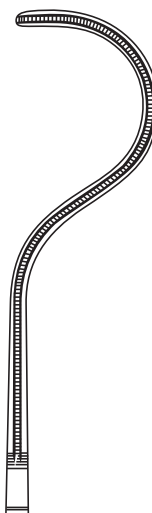

SF-16-240
180 mm

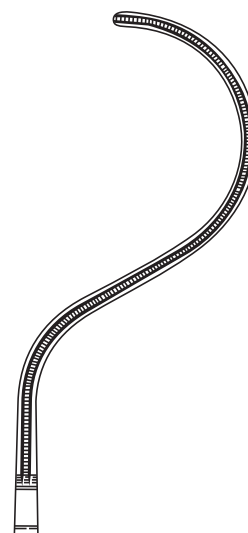

SF-16-241
185 mm

ATRAUMA

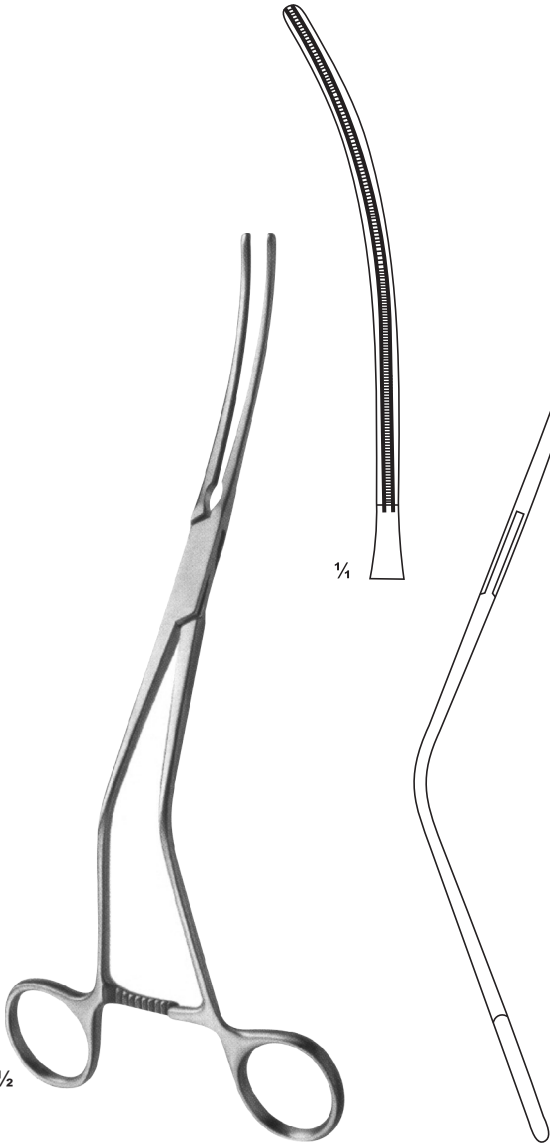

WYLIE
SF-16-242
240 mm

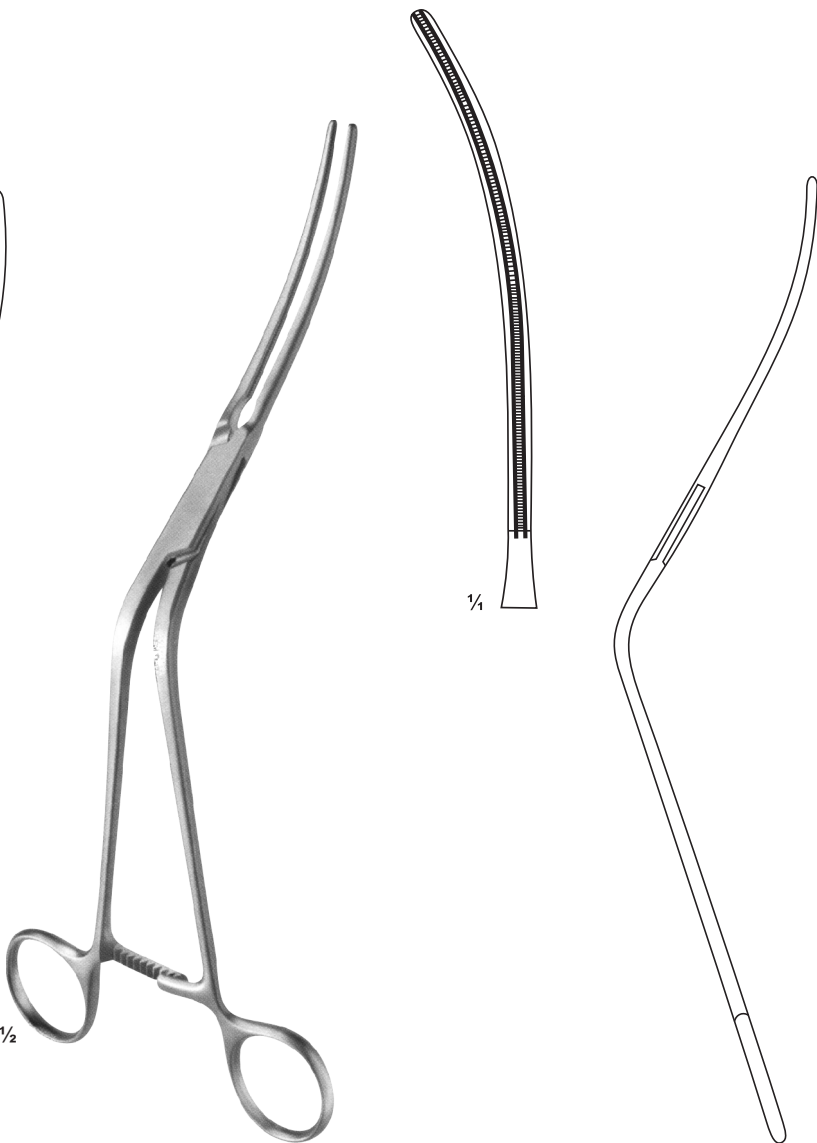

WYLIE
SF-16-243
270 mm

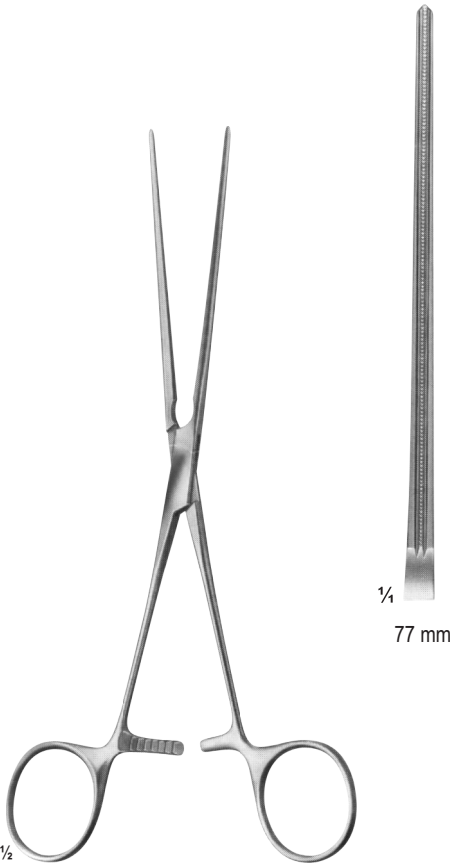

LELAND-JONES
SF-16-244
195 mm

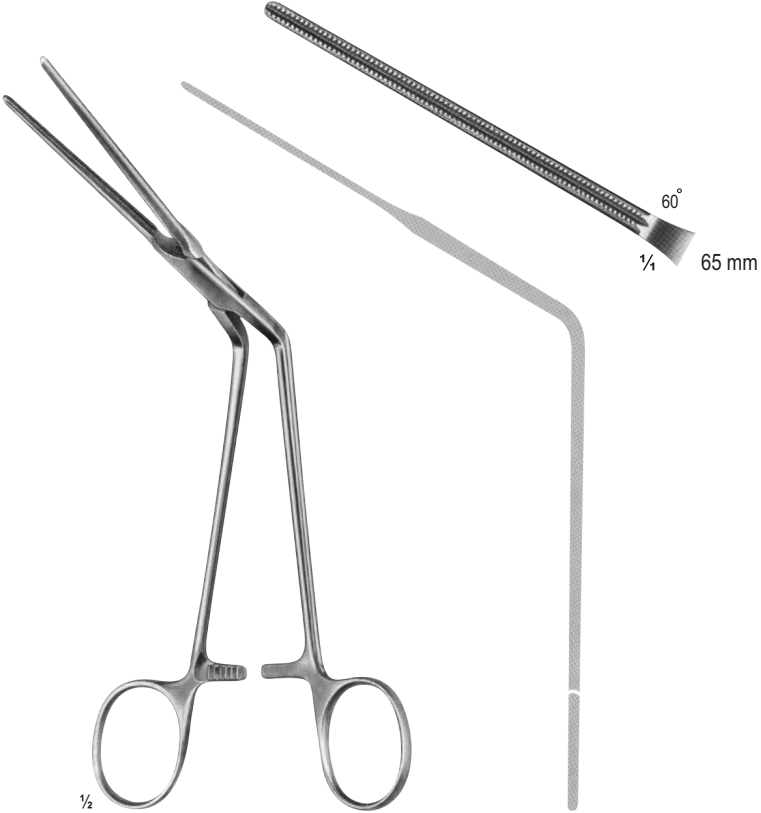

DE BAKEY
SF-16-245
200 mm Liliac Clamp



COOLEY
SF-16-246 120 mm
SF-16-247 125 mm
SF-16-248 125 mm

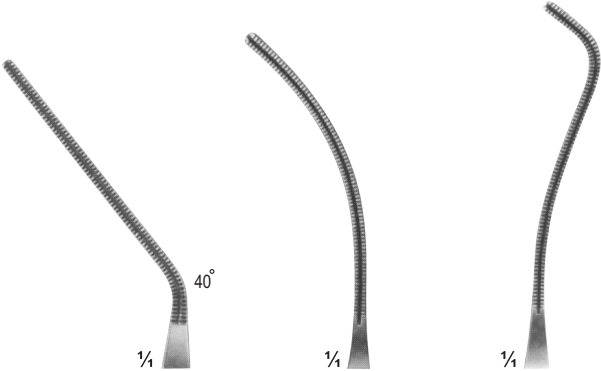

SF-16-246
50 mm

SF-16-247
50 mm

SF-16-248
52 mm

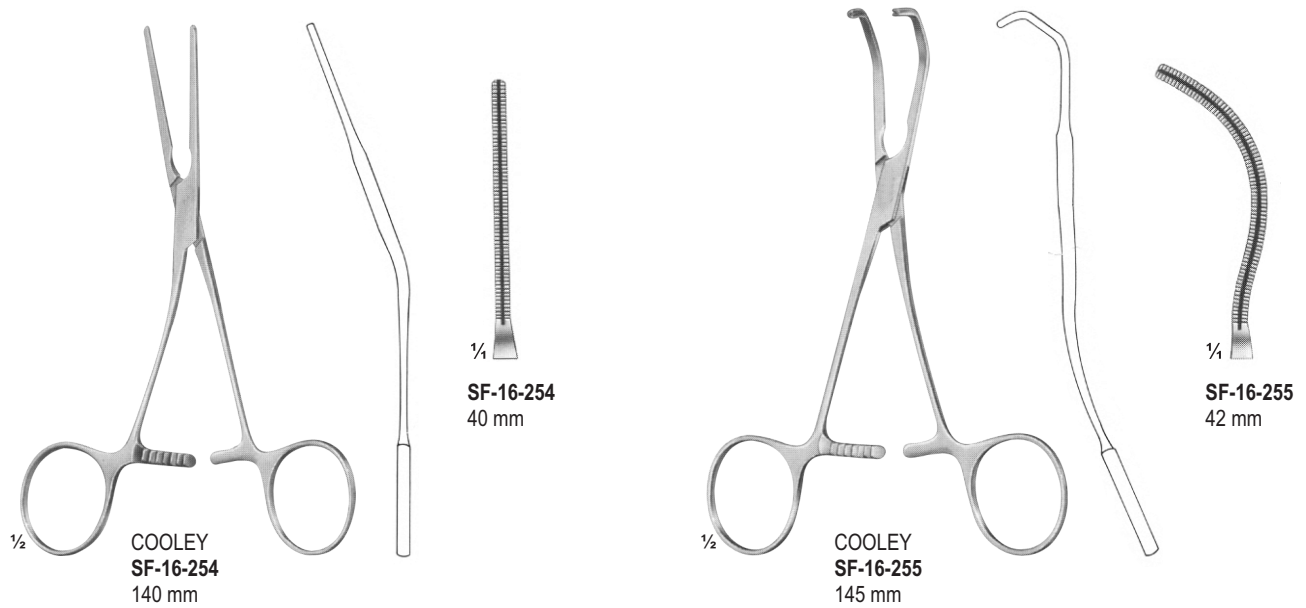
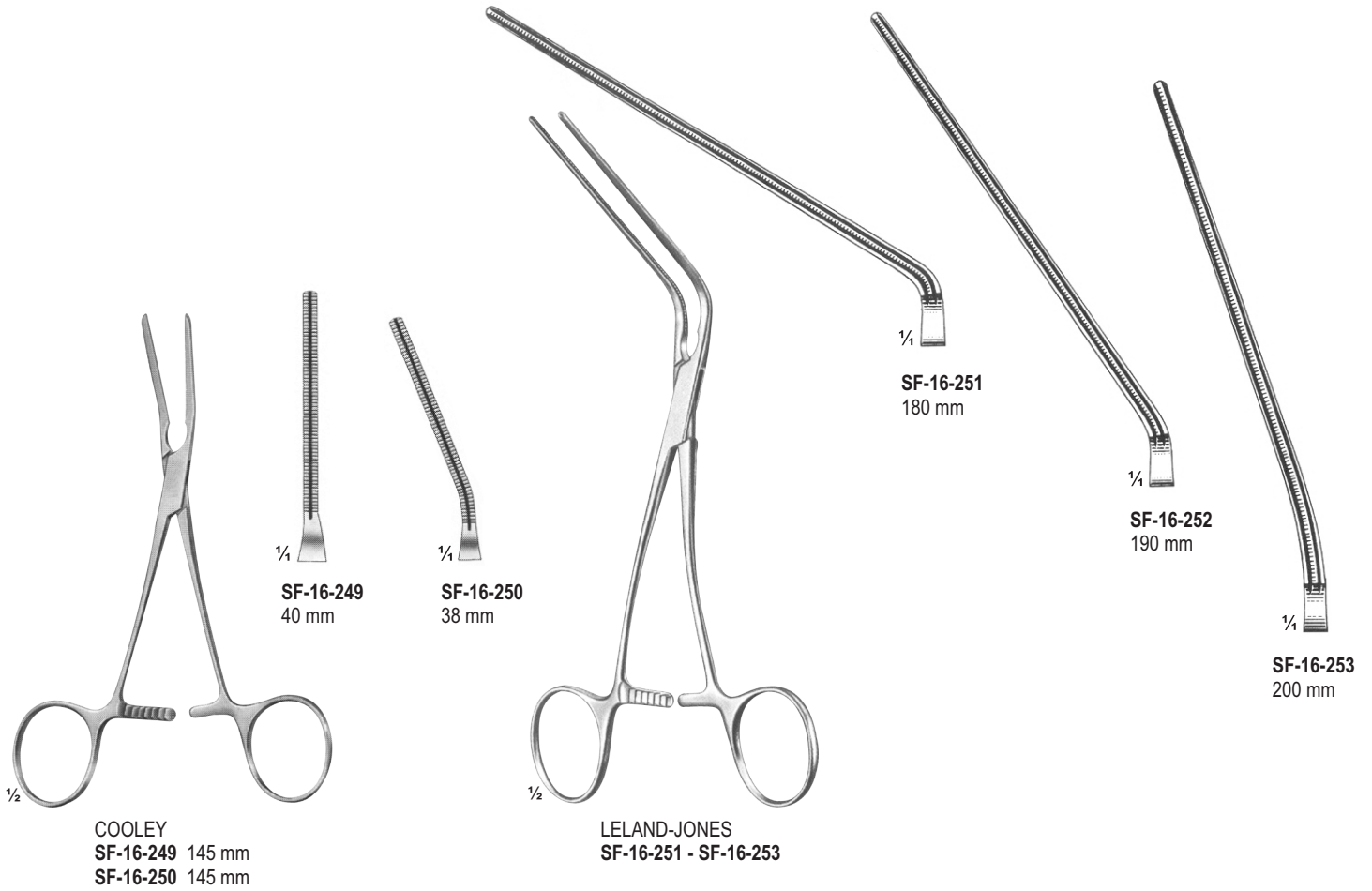



$\frac{1}{2}$
SF-16-256 - SF-16-258
DE BAKEY-SATINSKY
235 mm, 240 mm, 245 mm

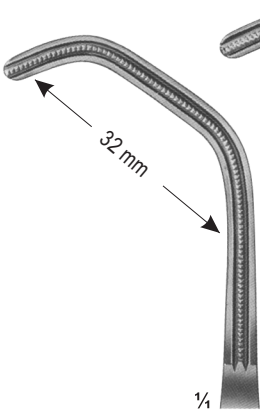

$\frac{1}{4}$
SF-16-256
68 mm

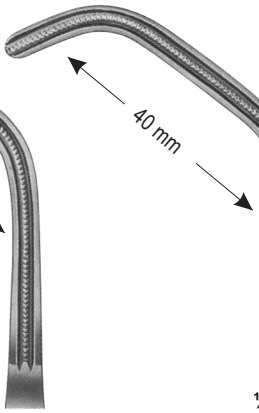

$\frac{1}{4}$
SF-16-257
76 mm

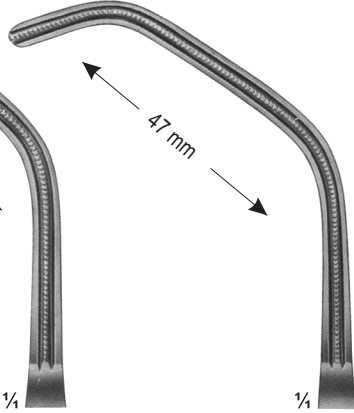

$\frac{1}{4}$
SF-16-258
84 mm

VASCULAR CLAMPS



$\frac{1}{2}$
SF-16-259 - SF-16-260
DE BAKEY
170 mm, 165 mm



$\frac{1}{4}$
SF-16-259
50 mm

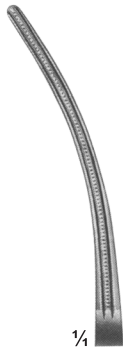

$\frac{1}{4}$
SF-16-260
50 mm



$\frac{1}{2}$
SF-16-261
DE BAKEY
165 mm

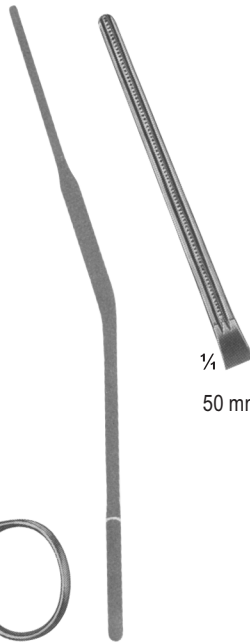

$\frac{1}{4}$
50 mm



$\frac{1}{2}$ SF-16-262 - SF-16-264
DE BAKEY
205 mm, 225 mm, 240 mm

$\frac{1}{4}$ SF-16-262 41 mm
SF-16-263 65 mm
SF-16-264 80 mm



$\frac{1}{2}$ SF-16-265 - SF-16-267
DE BAKEY
200 mm, 225 mm, 240 mm

$\frac{1}{4}$ SF-16-265 41 mm
SF-16-266 65 mm
SF-16-267 80 mm

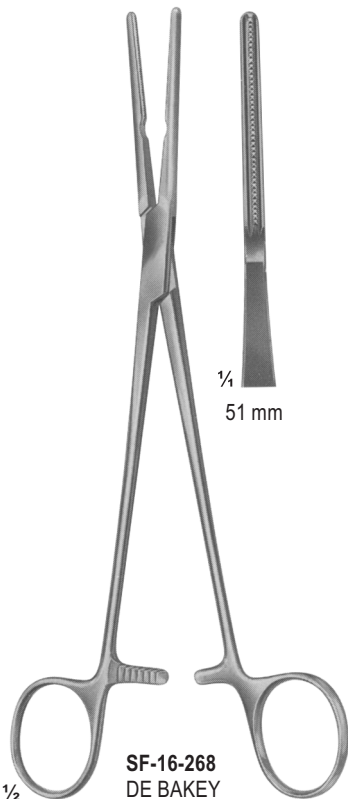

$\frac{1}{2}$ SF-16-268
DE BAKEY
210 mm

$\frac{1}{4}$ 51 mm



$\frac{1}{2}$ SF-16-269
DE BAKEY
210 mm

15°
 $\frac{1}{4}$ 51 mm

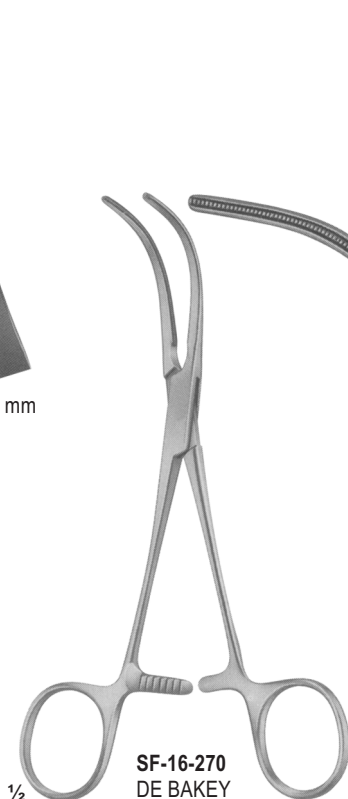

$\frac{1}{2}$ SF-16-270
DE BAKEY
160 mm

$\frac{1}{4}$ 56 mm

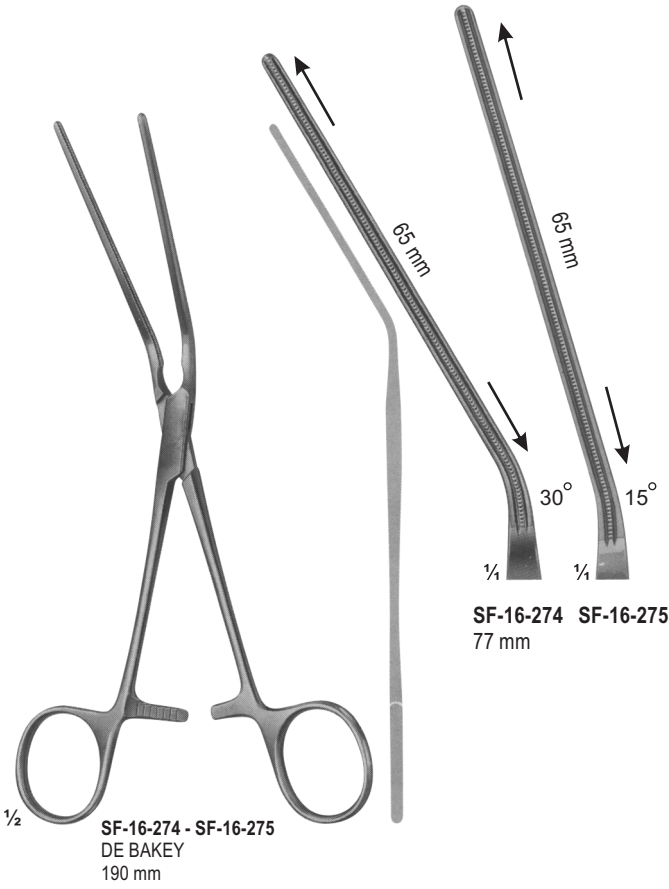
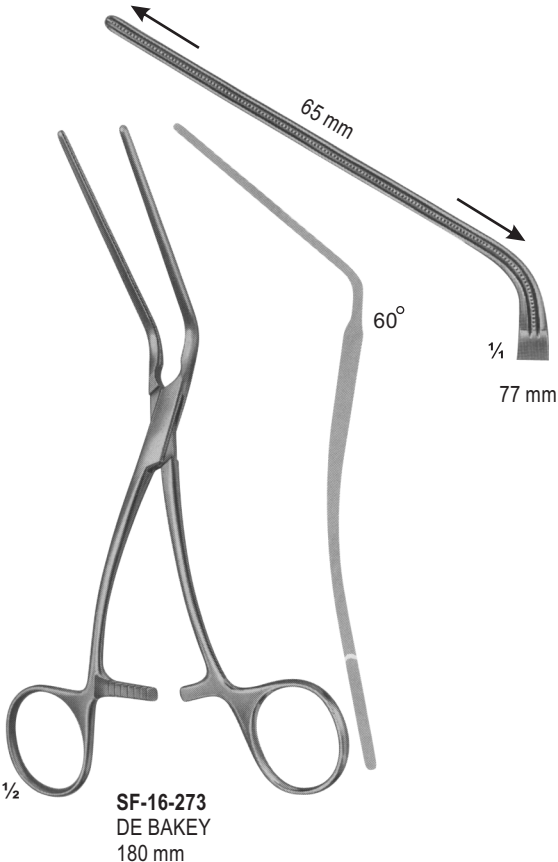
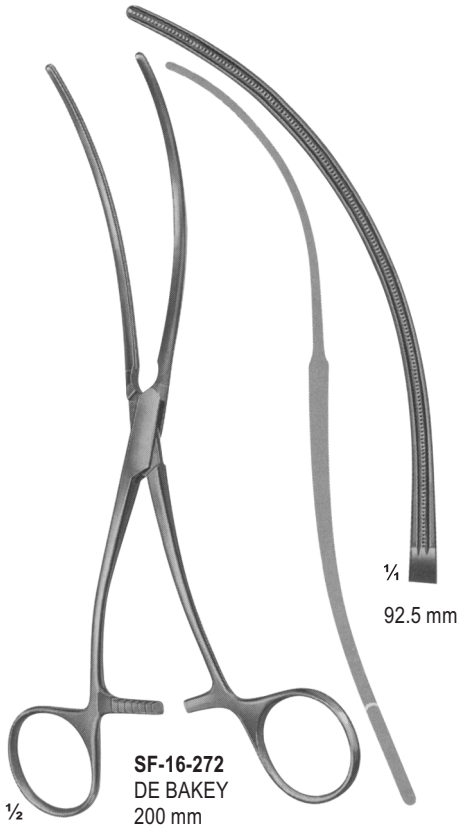
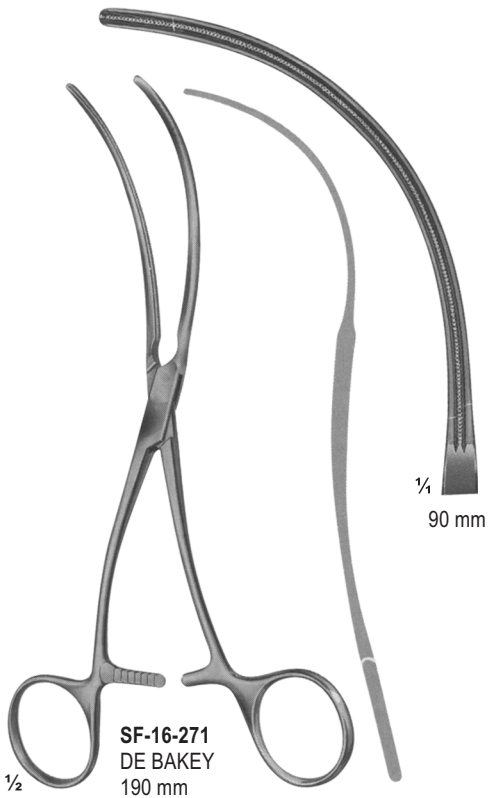

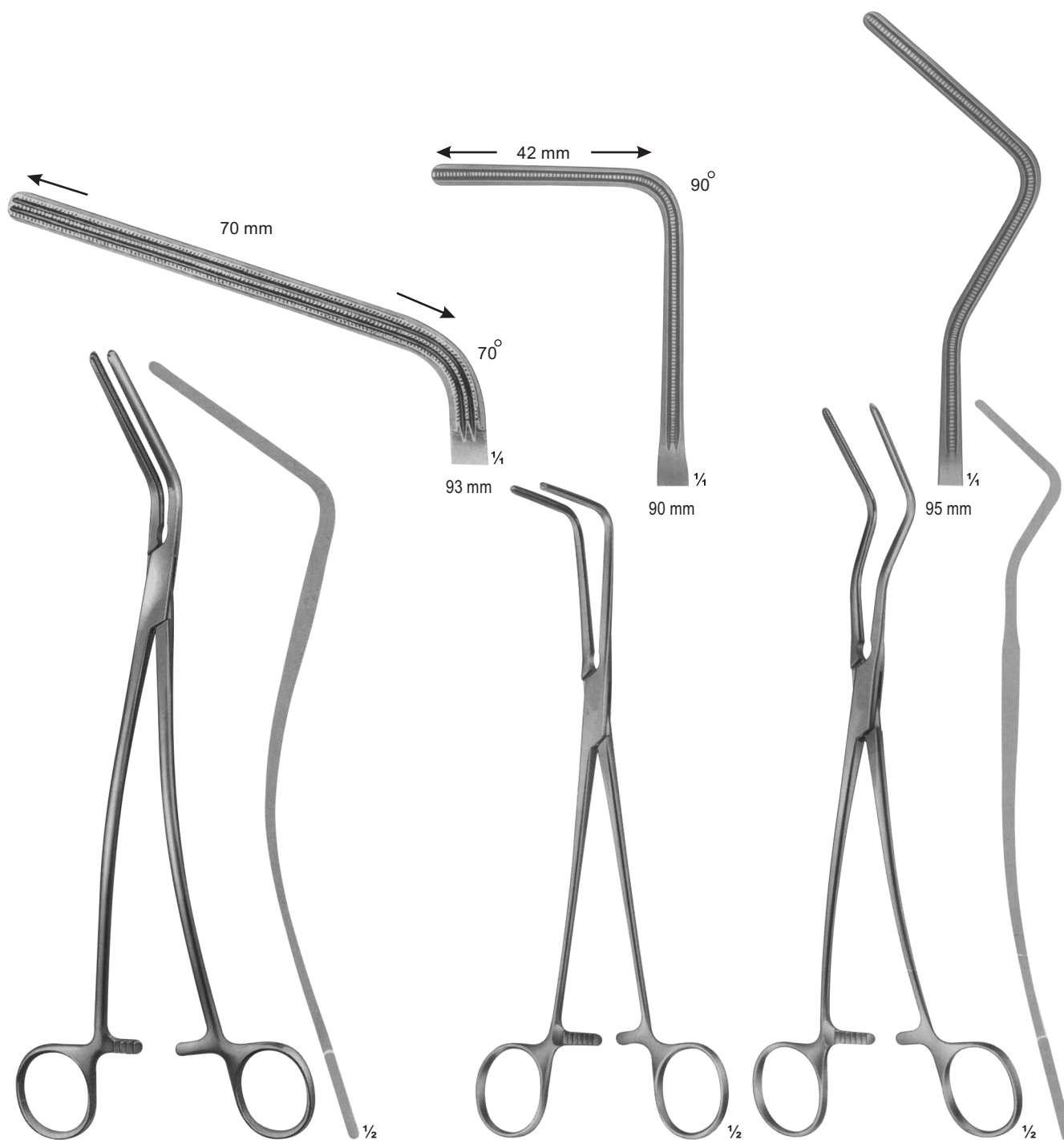

SF-16-276
DE BAKEY
240 mm

SF-16-277
LEES
220 mm

SF-16-278
LEES
245 mm

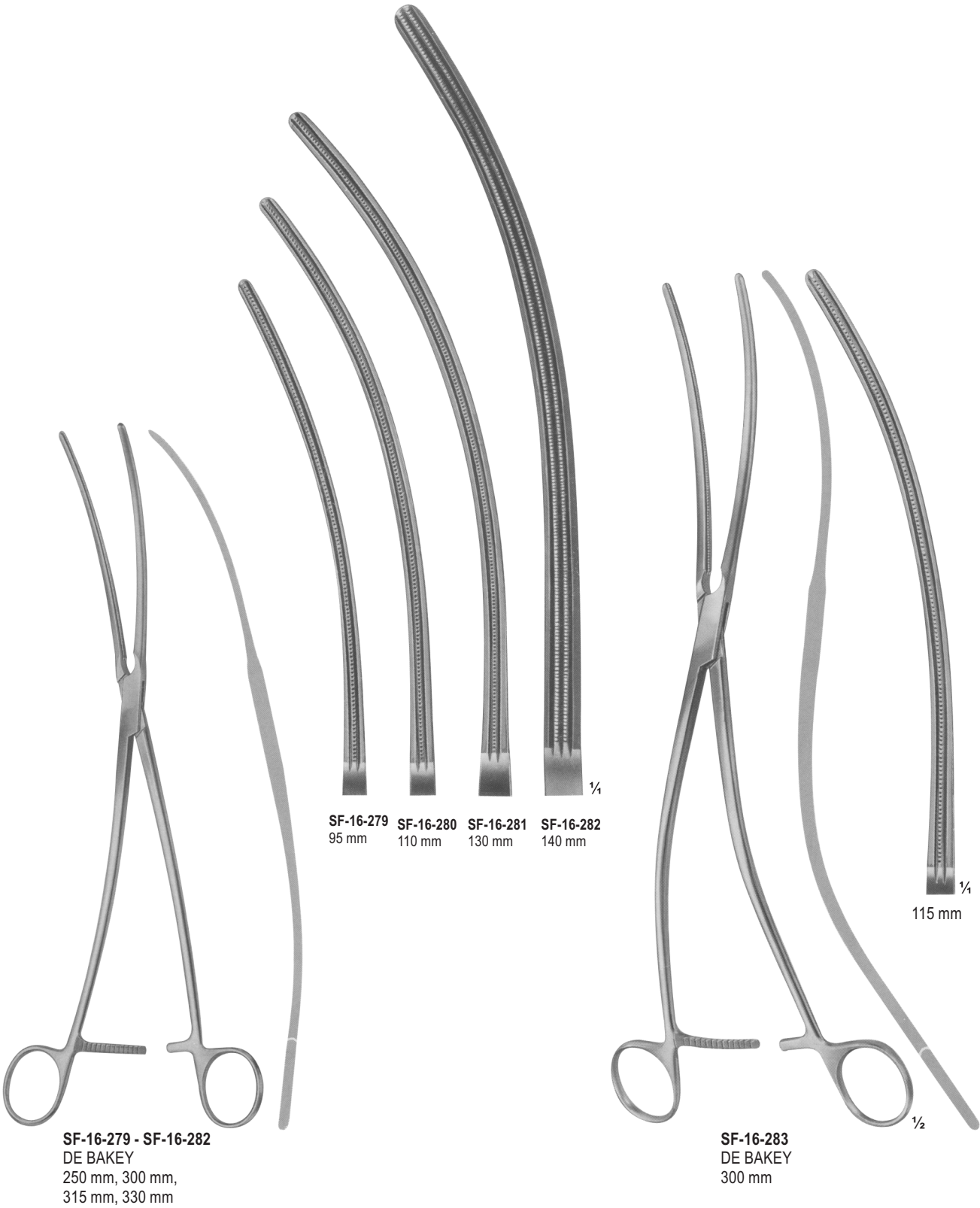

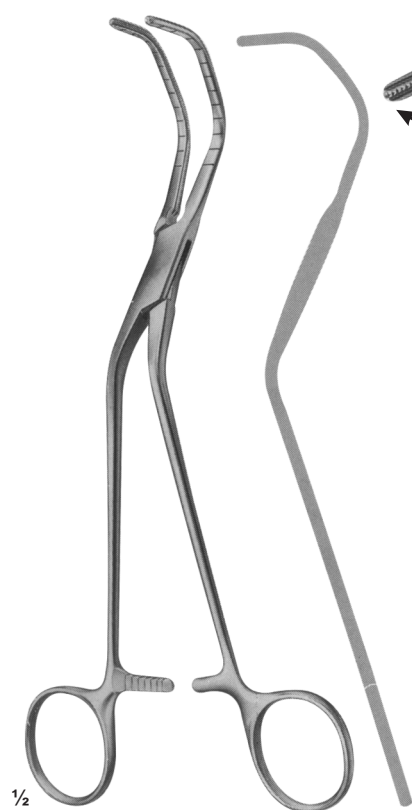

SF-16-284
DIETRICH
210 mm

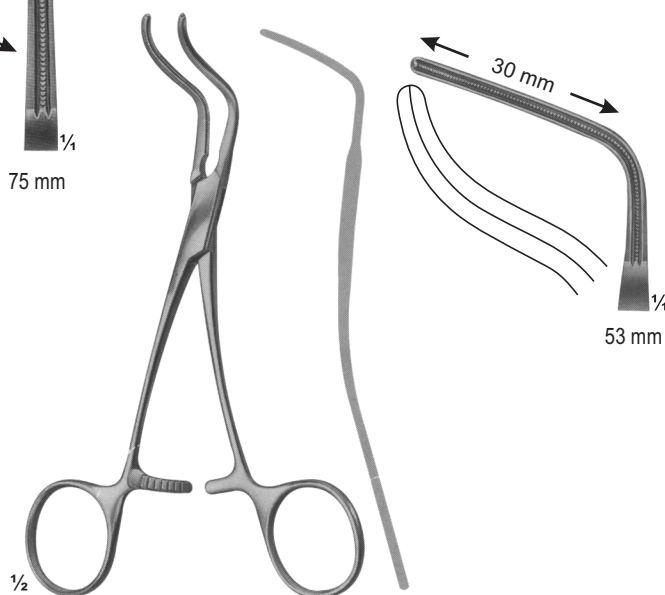

SF-16-285
SUBRAMANIAN
155 mm

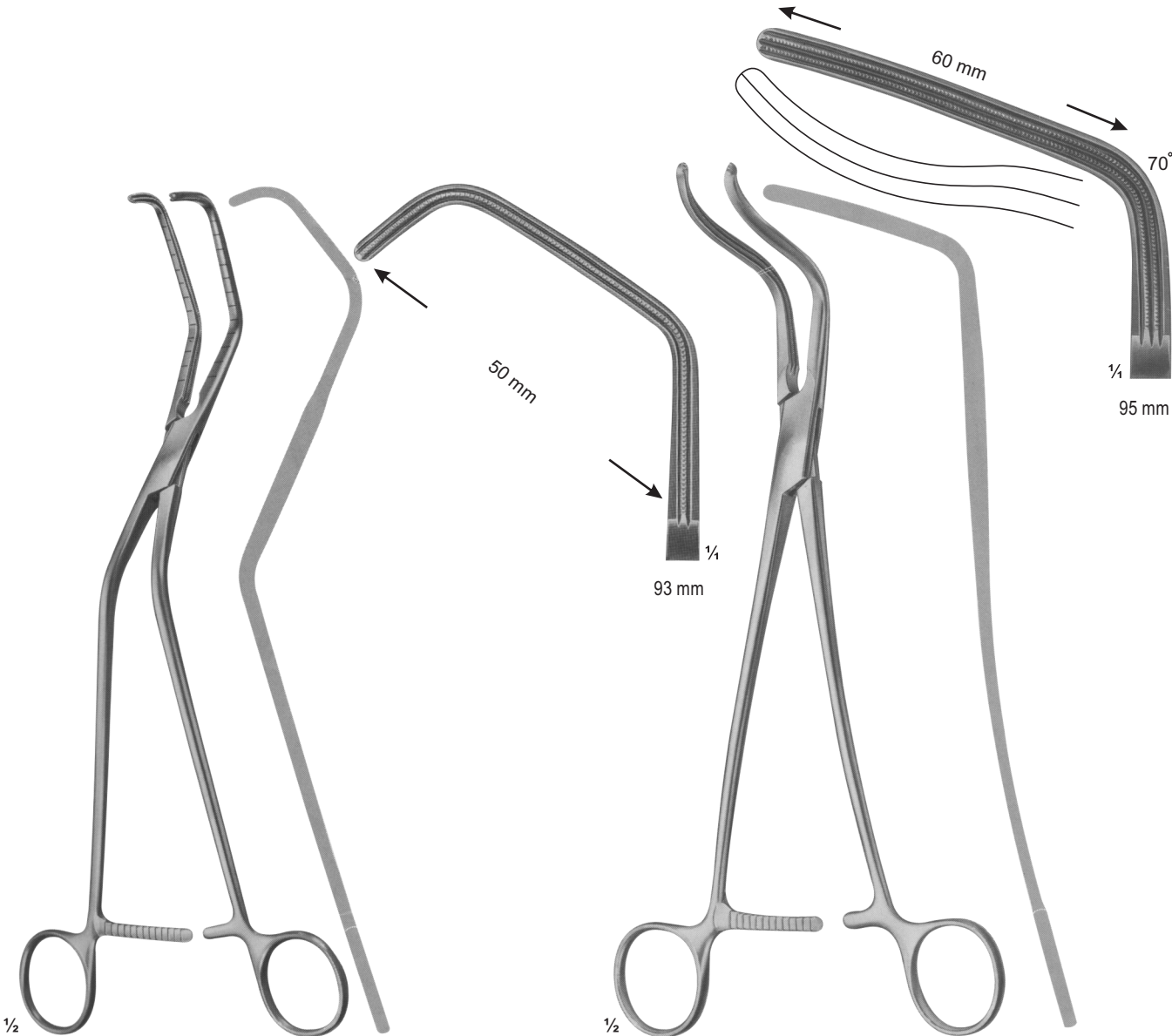

1/2
SF-16-286
OCHSNER
260 mm

1/2
SF-16-287
DE BAKEY
265 mm

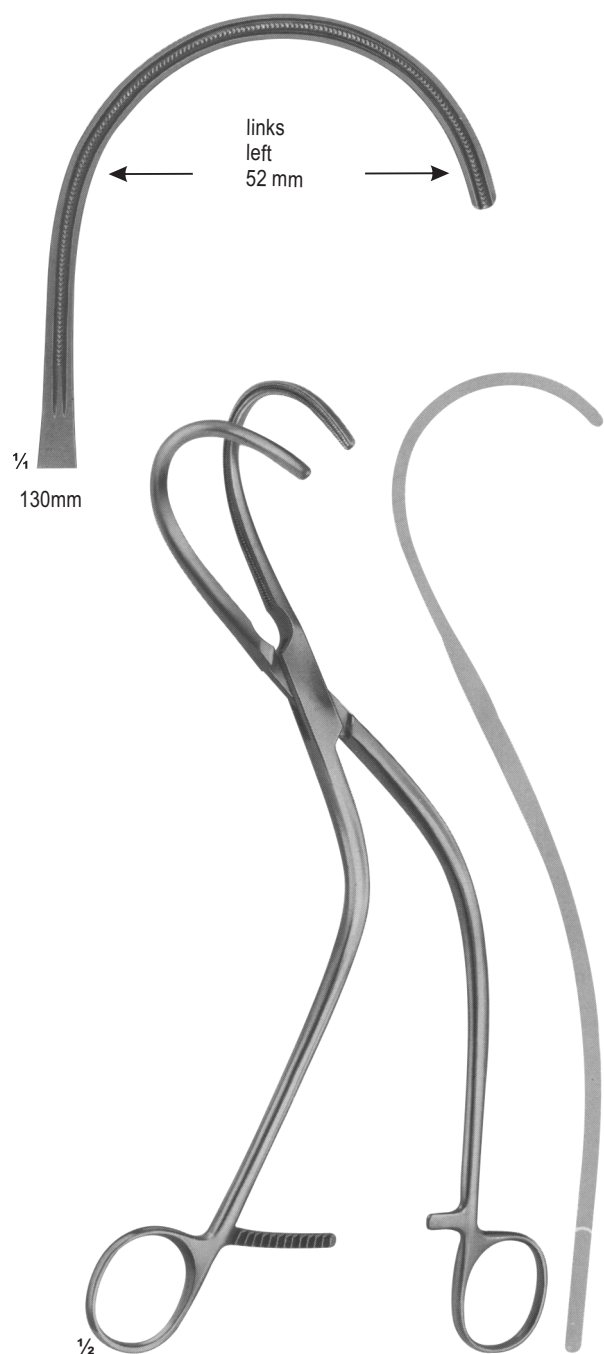

SF-16-288
WEBER
265 mm

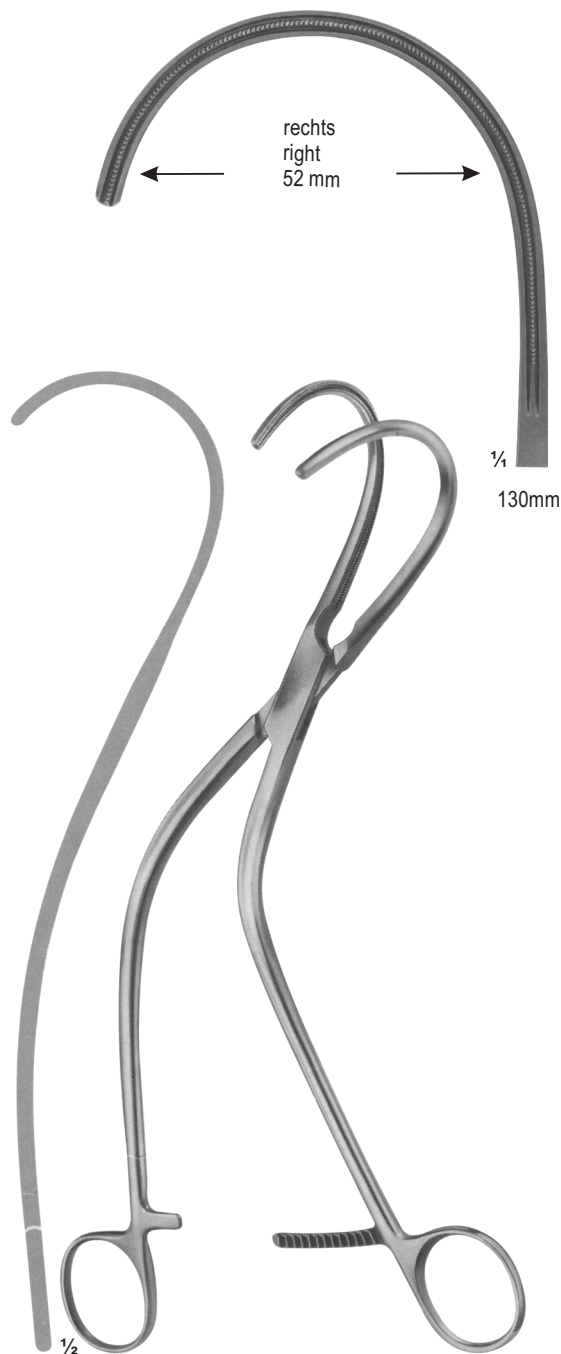

SF-16-289
WEBER
265 mm



SF-16-290 - SF-16-293
DE BAKEY

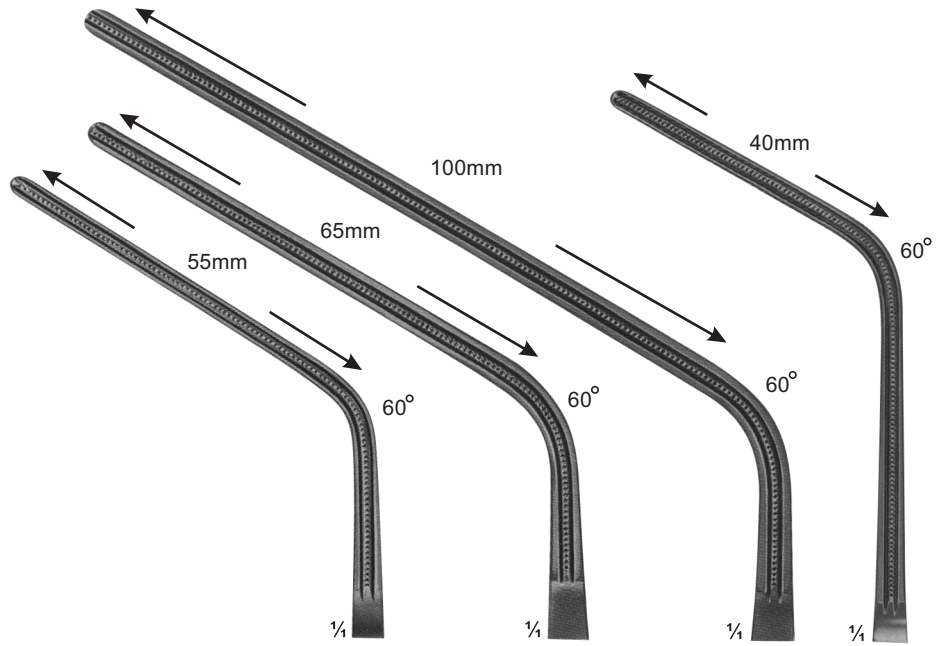

	SF-16-290	SF-16-291	SF-16-292	SF-16-293
Total Length:	230 mm	280 mm	305 mm	240 mm
Length of jaws:	85 mm	100 mm	135 mm	93 mm



SF-16-294 - SF-16-297
DE BAKEY

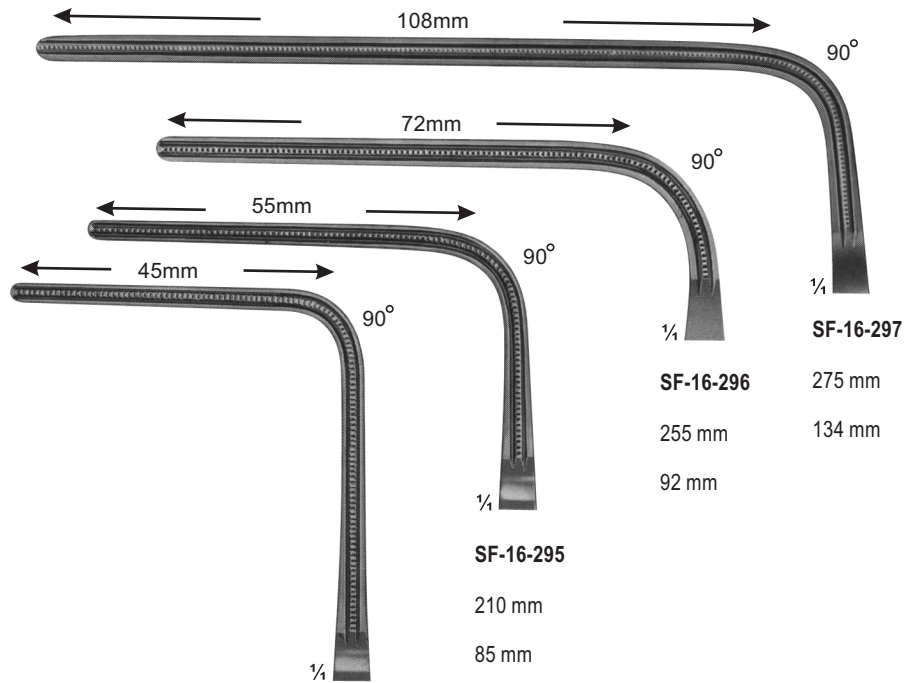

	SF-16-294	SF-16-295	SF-16-296	SF-16-297
Total Length:	225 mm	210 mm	255 mm	275 mm
Length of jaws:	93 mm	85 mm	92 mm	134 mm

RING HANDLE BULLDOG CLAMPS

www.surgiforce.com

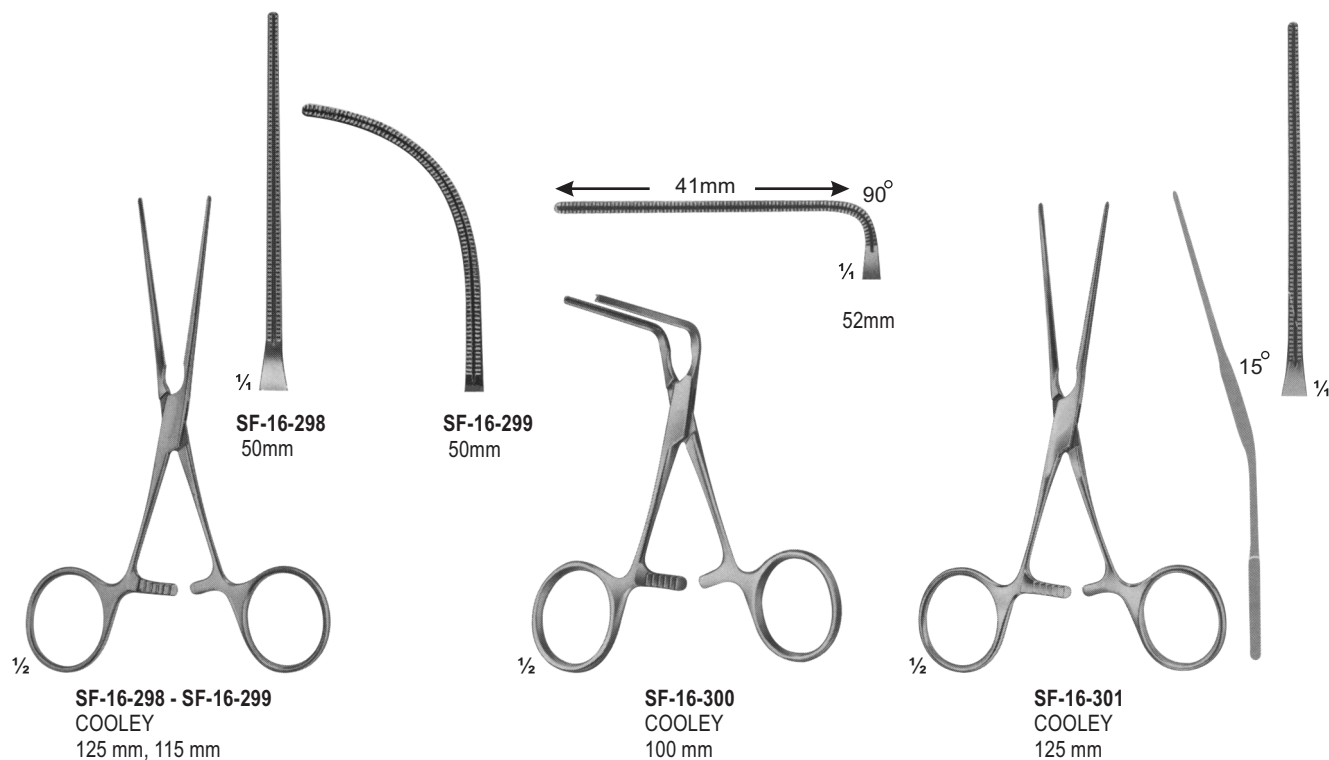

ANASTOMOSIS CLAMPS, PEDIATRIC PATTERNS

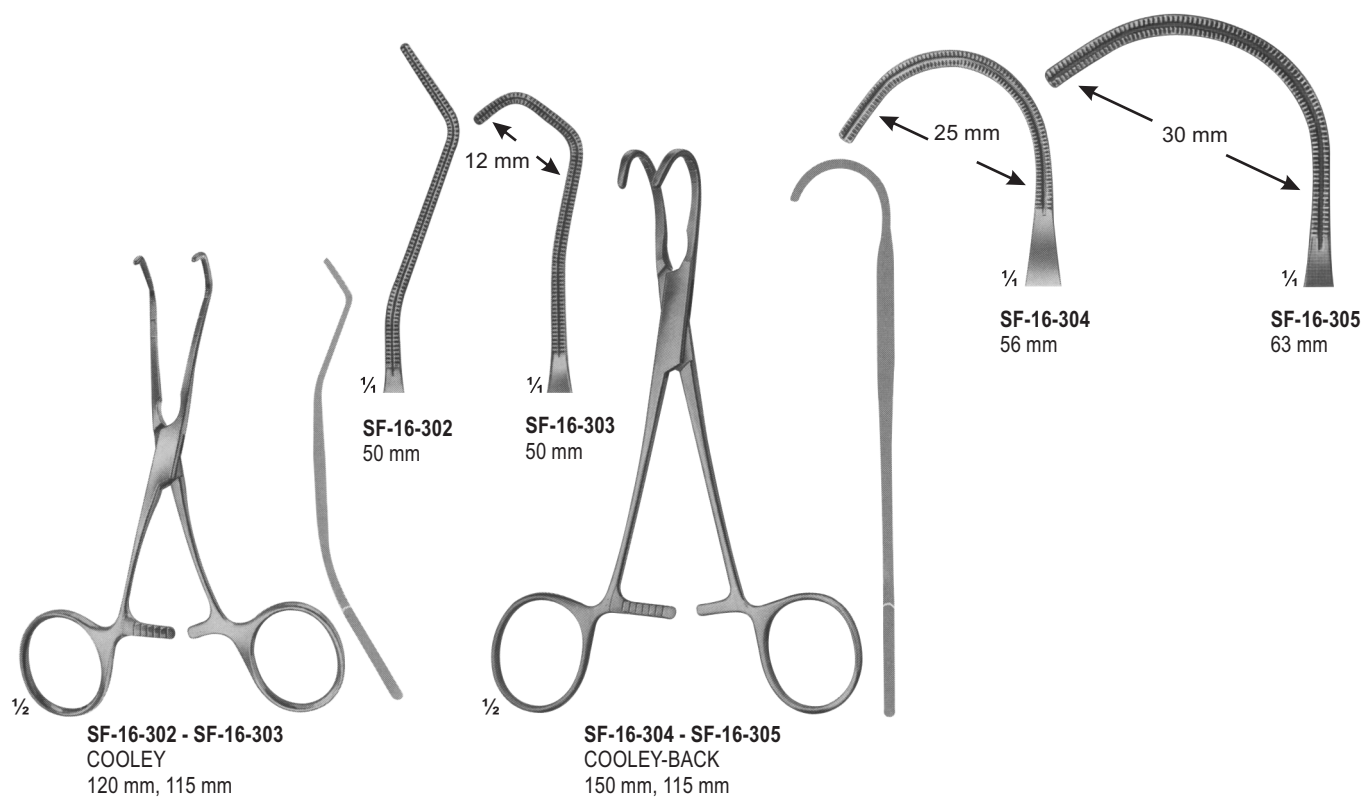

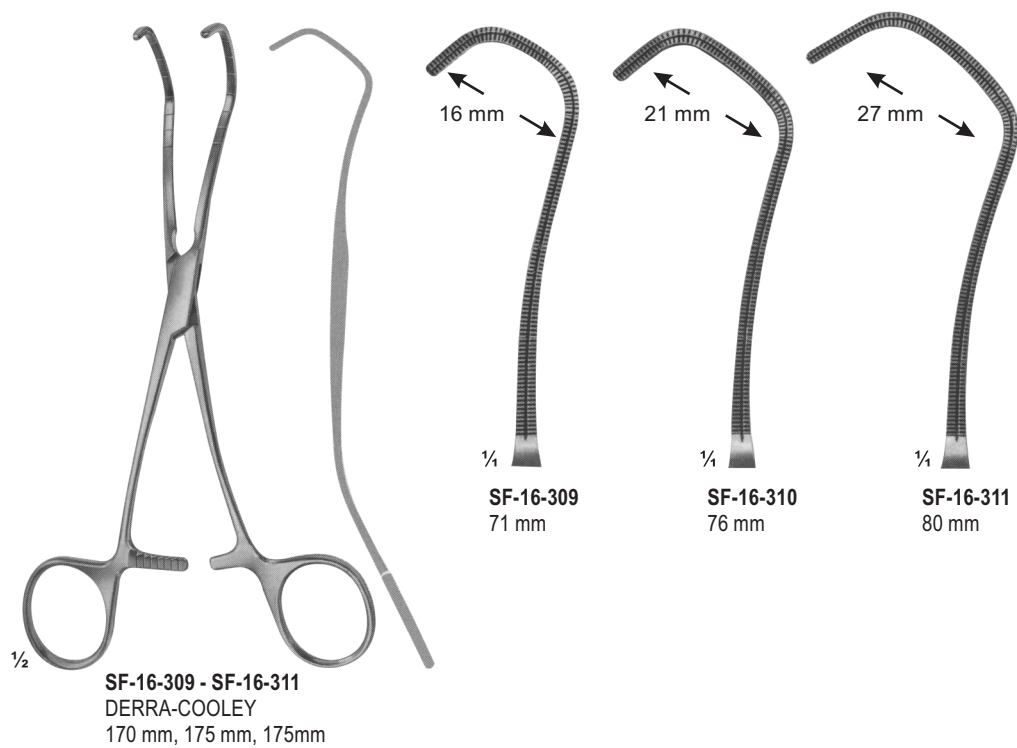
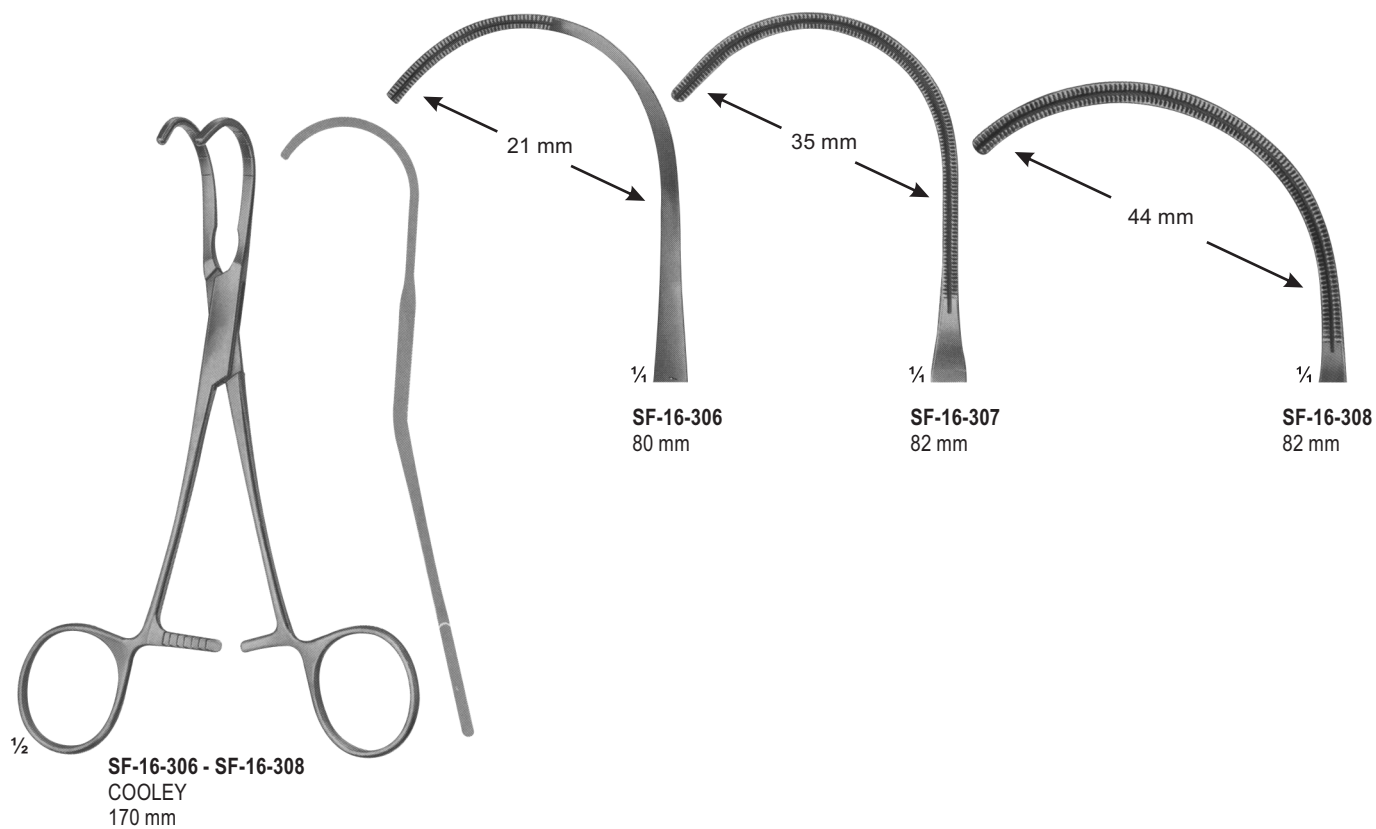

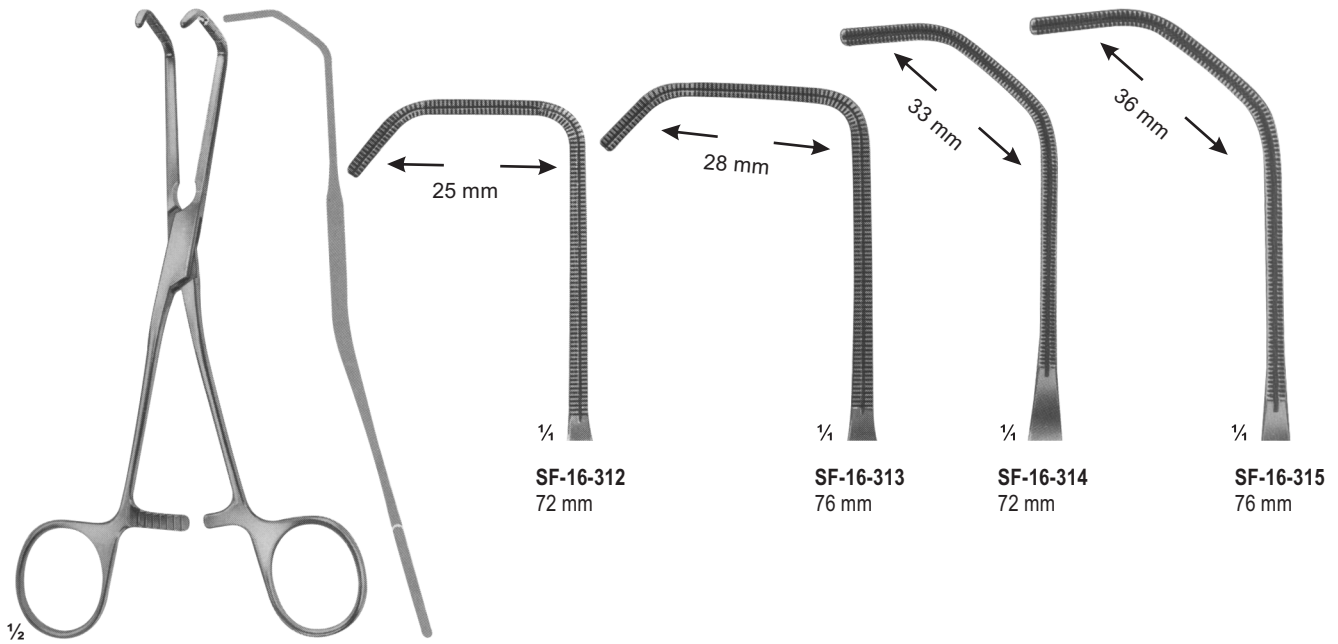

SF-16-312 - SF-16-315
 COOLEY
 165 mm, 165 mm
 175 mm, 180 mm

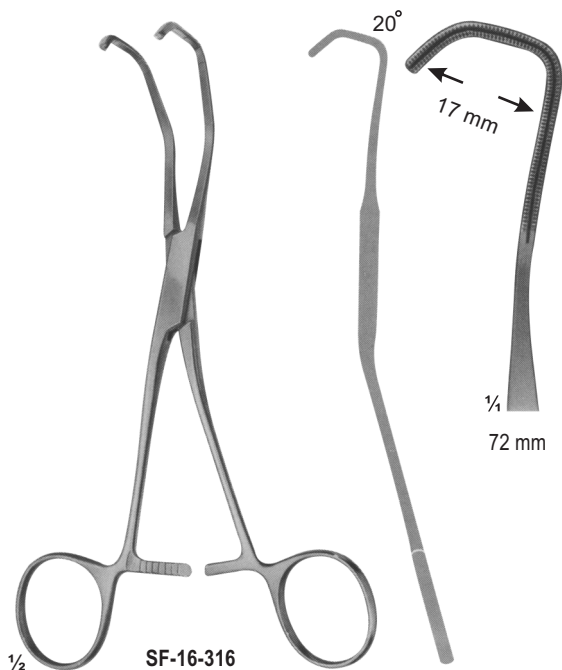

SF-16-316
 COOLEY
 170 mm

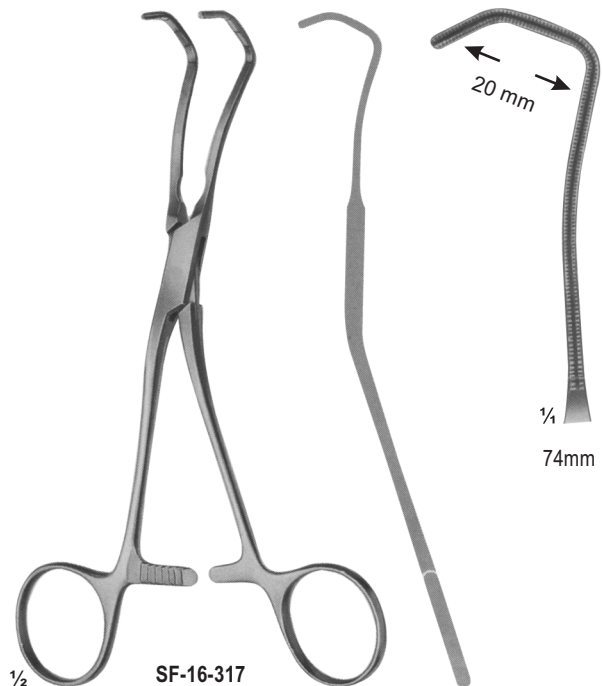

SF-16-317
 COOLEY
 175 mm

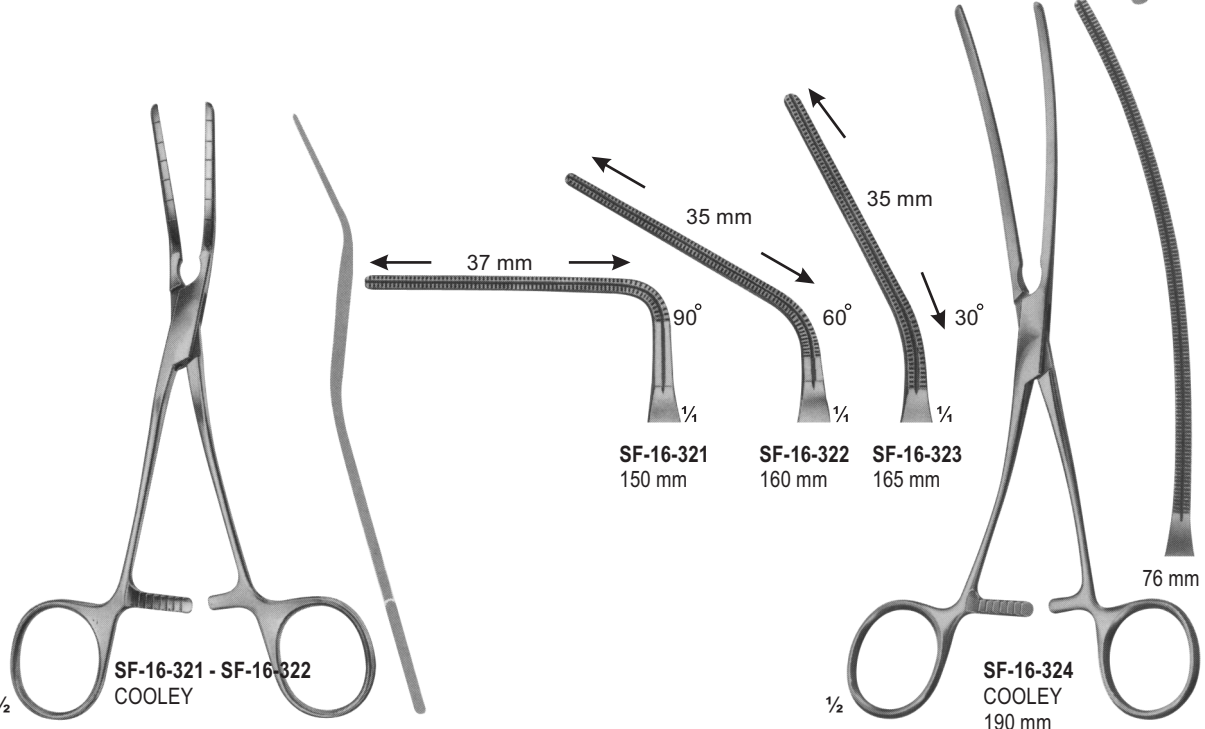
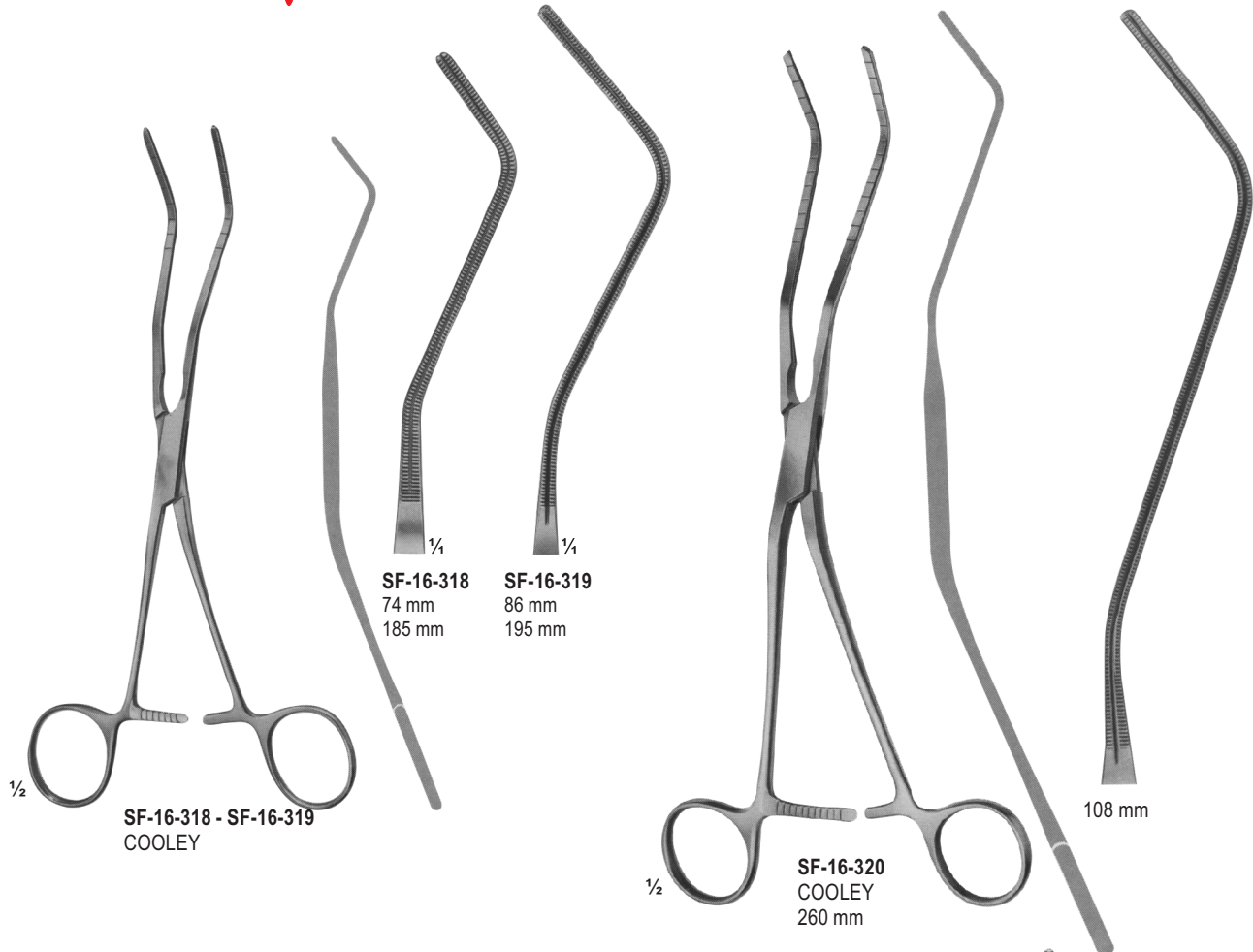

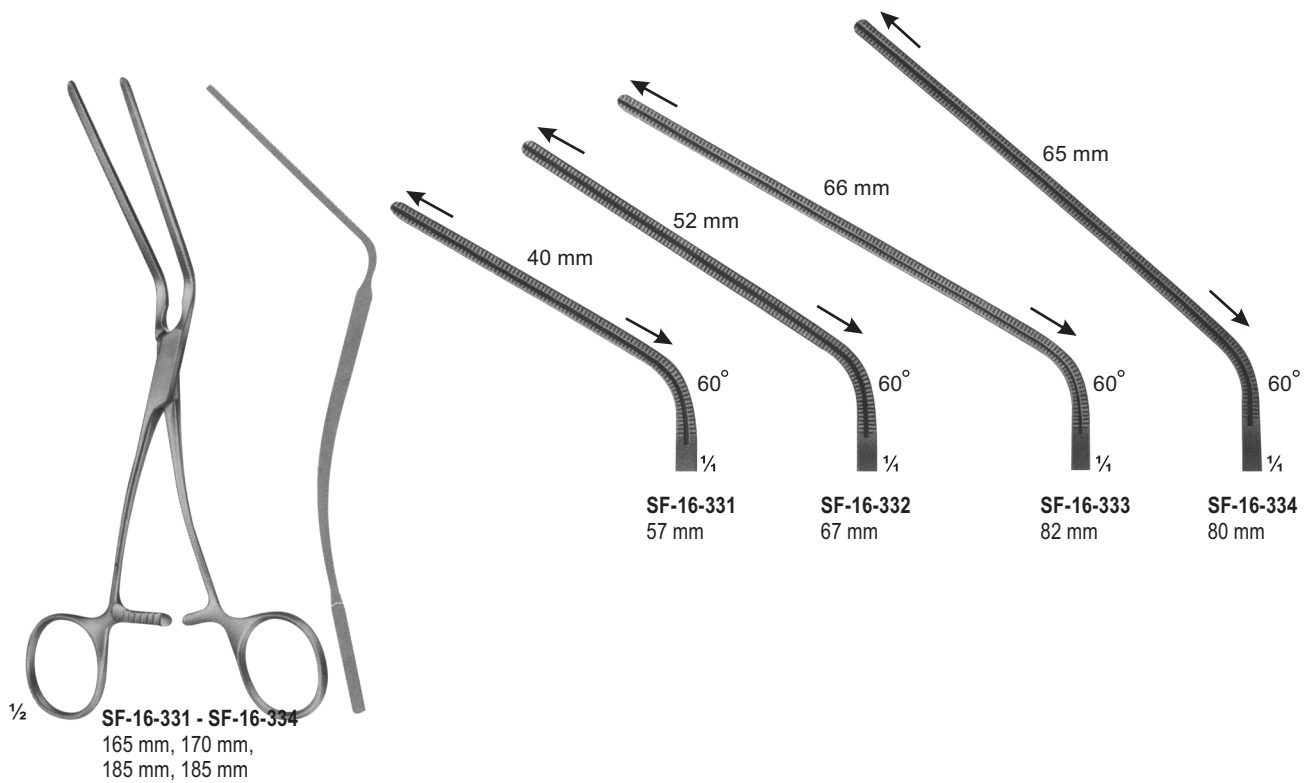
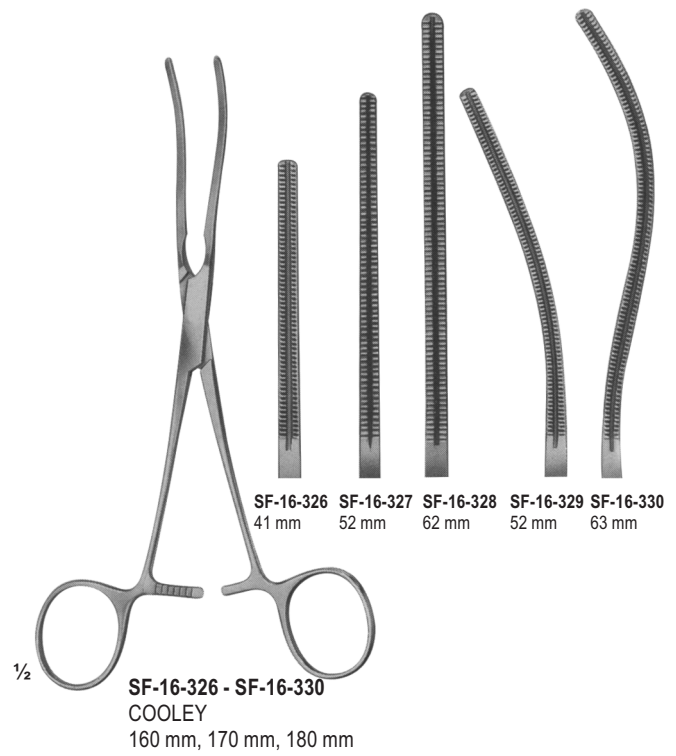
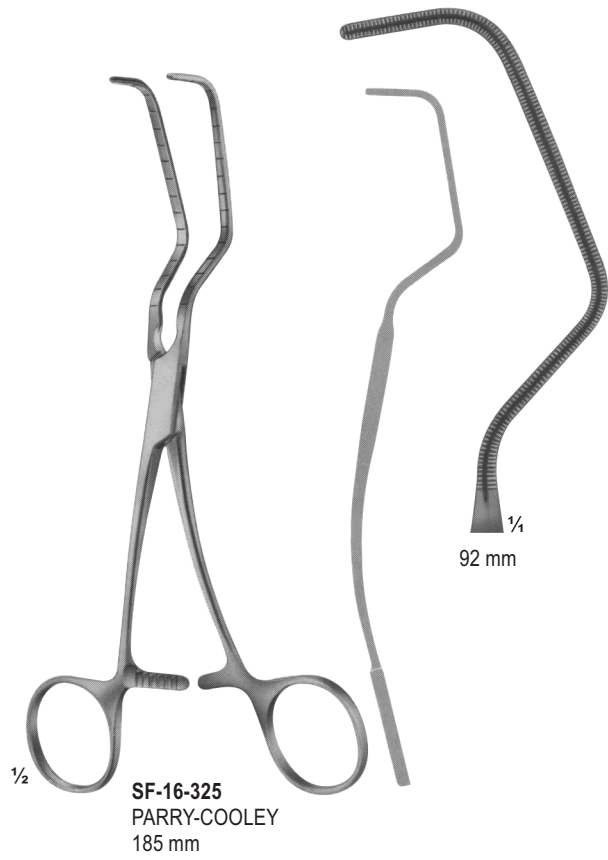



1/2 DARDIK
SF-16-335 150 mm
SF-16-336 150 mm
SF-16-337 150 mm
SF-16-338 145 mm
SF-16-339 130 mm

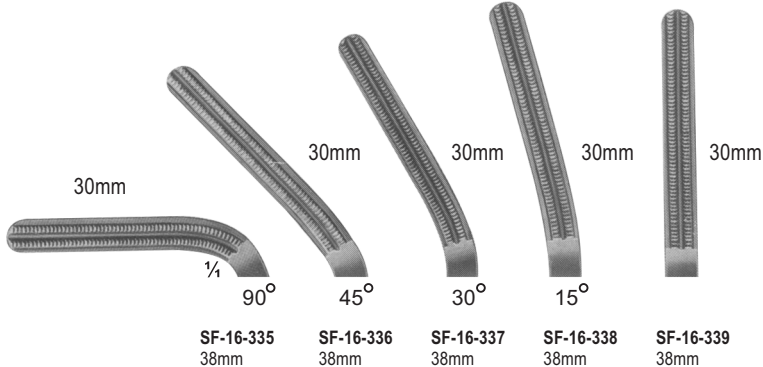

1/2 DARDIK
SF-16-335 170 mm
SF-16-336 170 mm
SF-16-337 170 mm
SF-16-338 160 mm
SF-16-339 135 mm

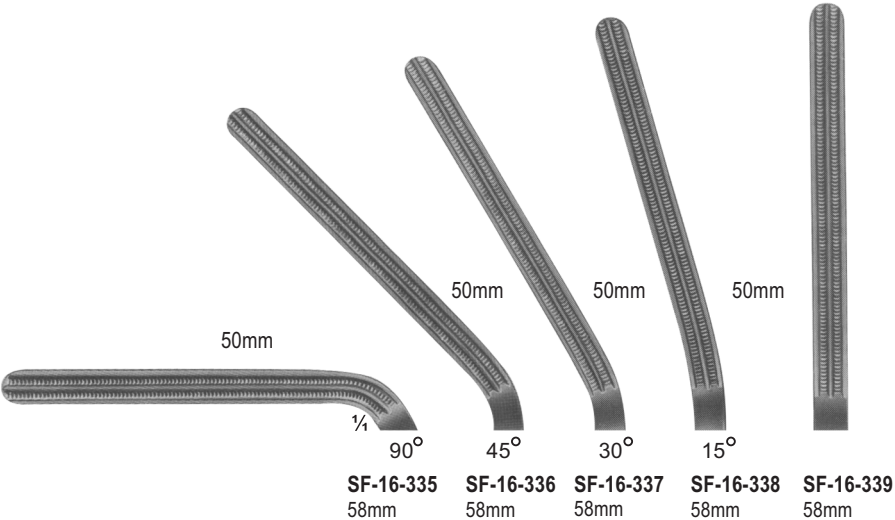

MULTI-PURPOSE CLAMPS

www.surgiforce.com

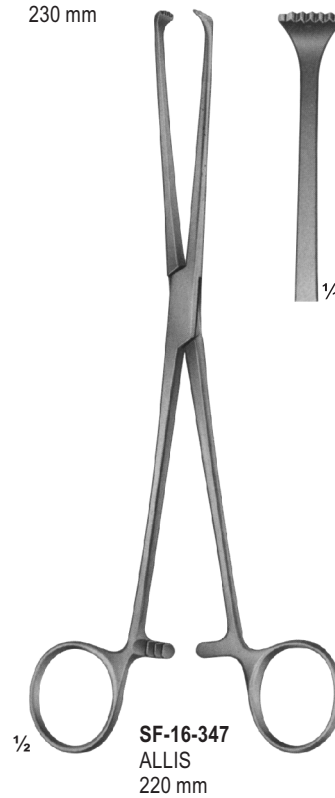
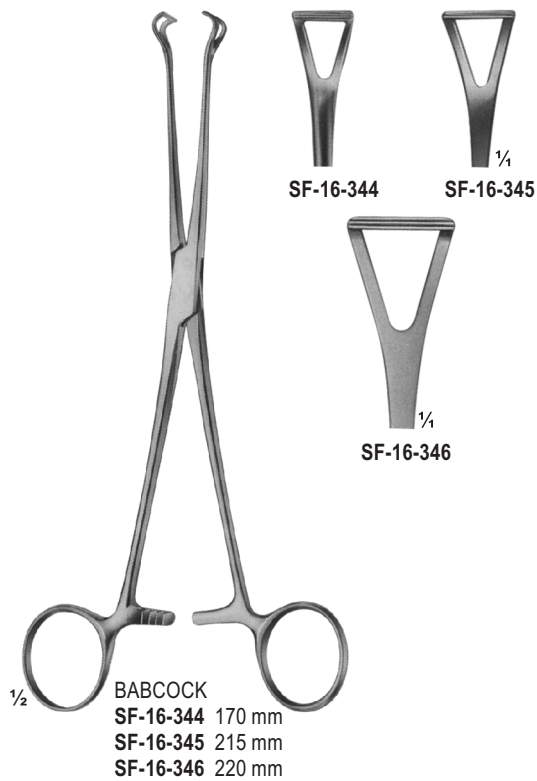
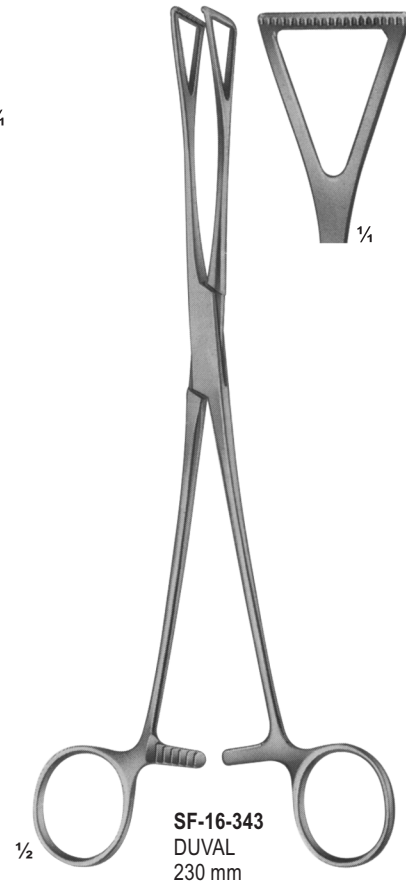
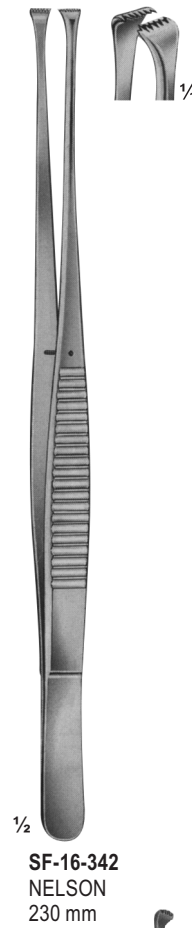

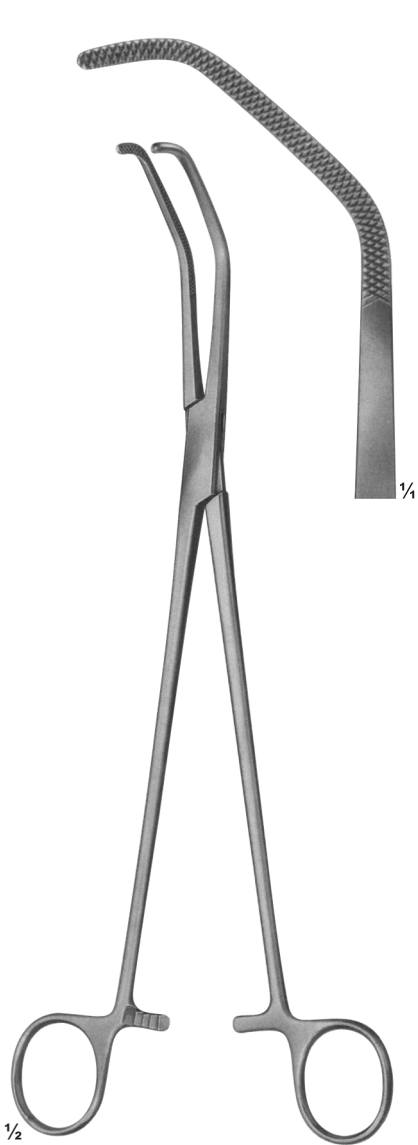

SF-16-348
SATINSKY
265 mm



SF-16-349
SATINSKY
265 mm

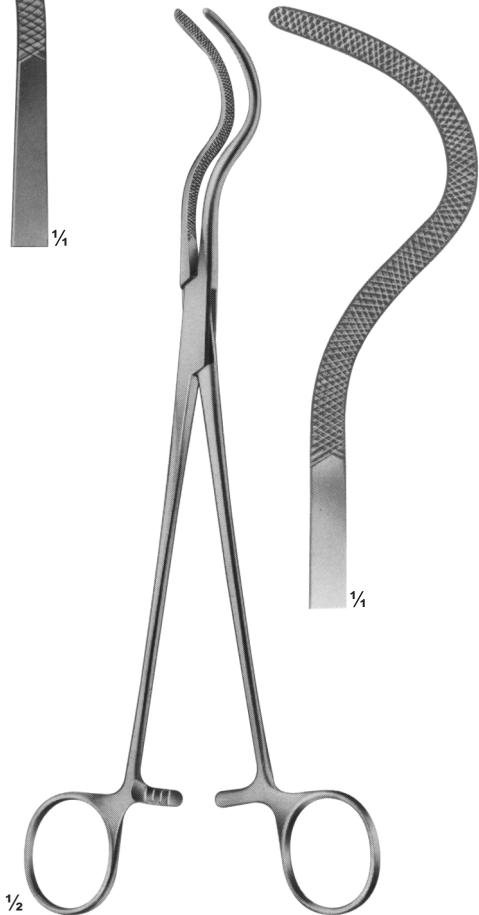

SF-16-350
HARKEN
240 mm

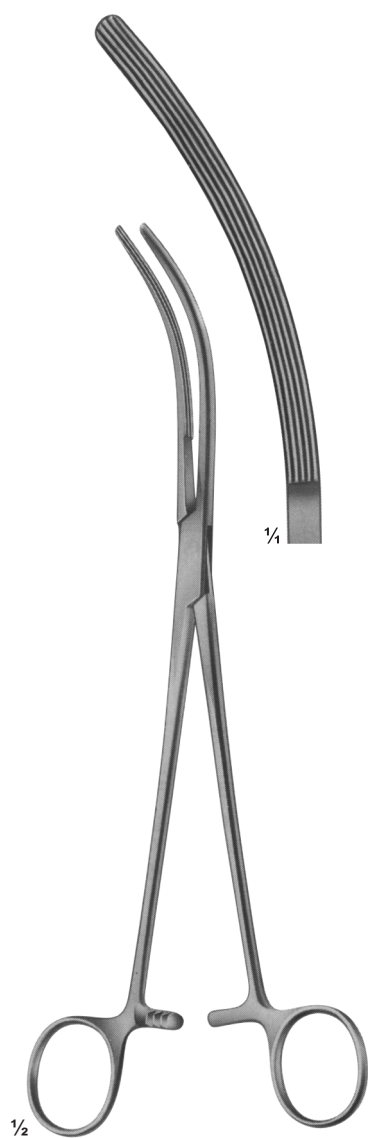

SF-16-351
CRAFOORD-SELLORS
240 mm

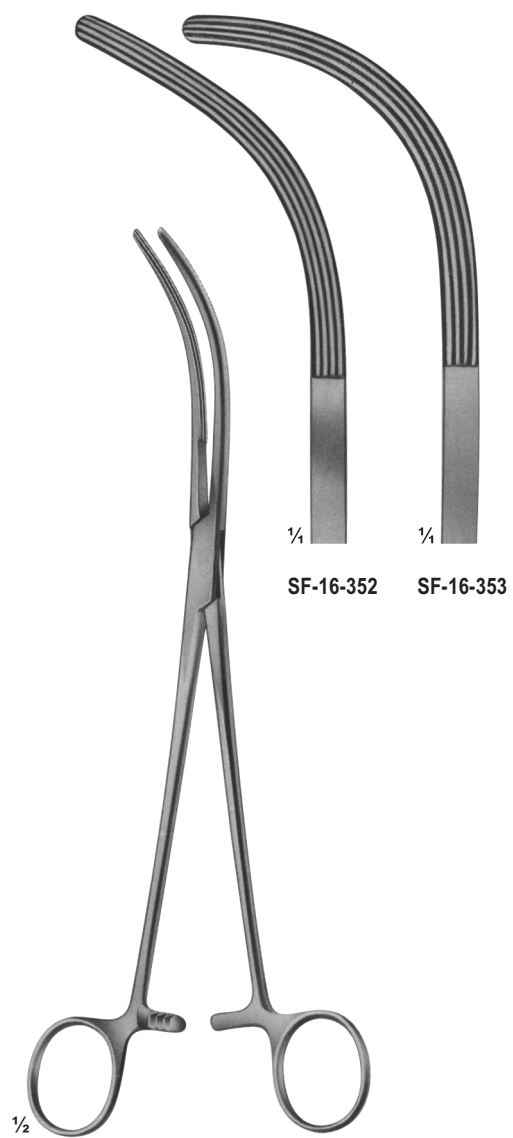

SF-16-352 - SF-16-353
CRAFOORD
240 mm



SF-16-354
PRICE THOMAS
225 mm



SF-16-355 - SF-16-356
PRICE THOMAS
225 mm

SF-16-355
jaws with pins

SF-16-356
jaws with pins

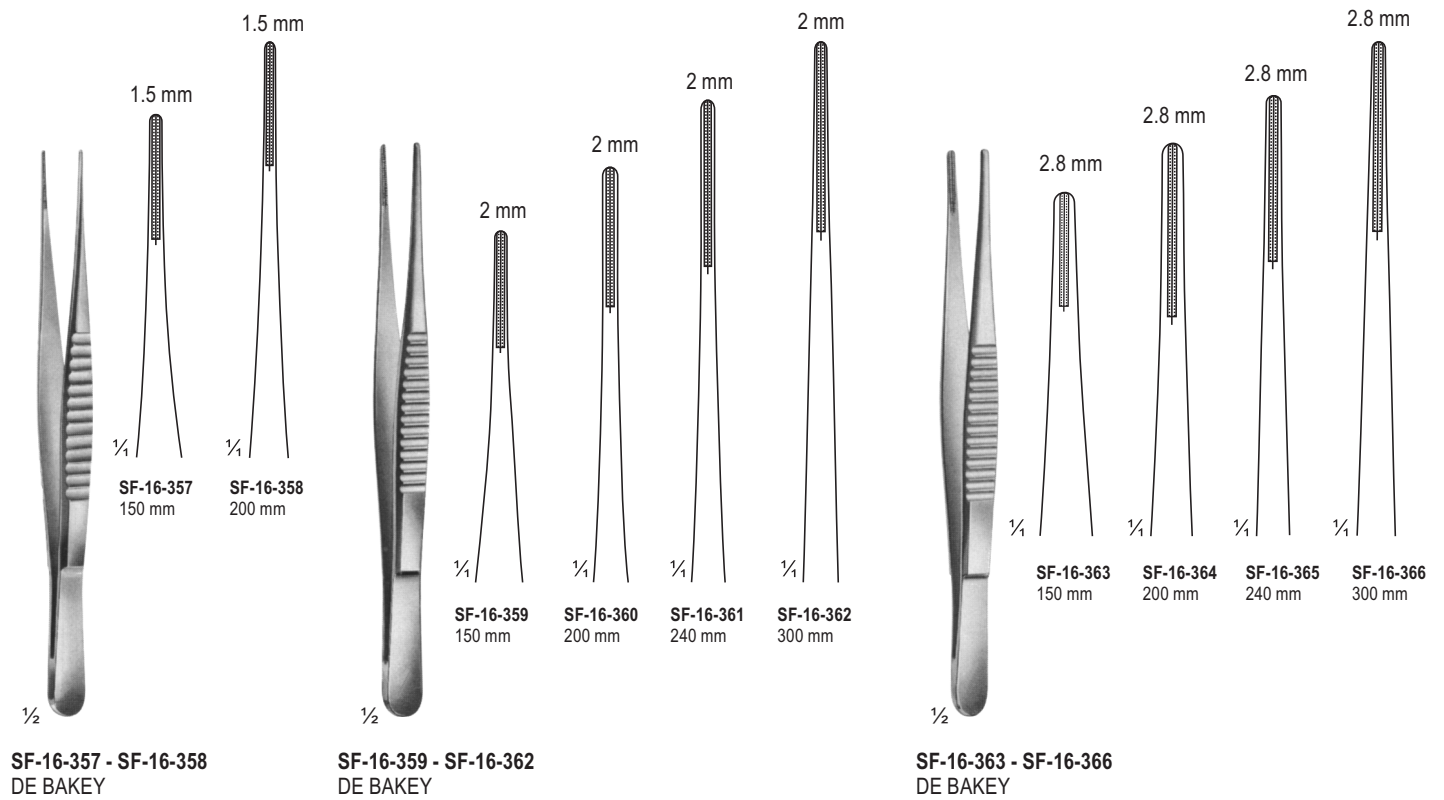

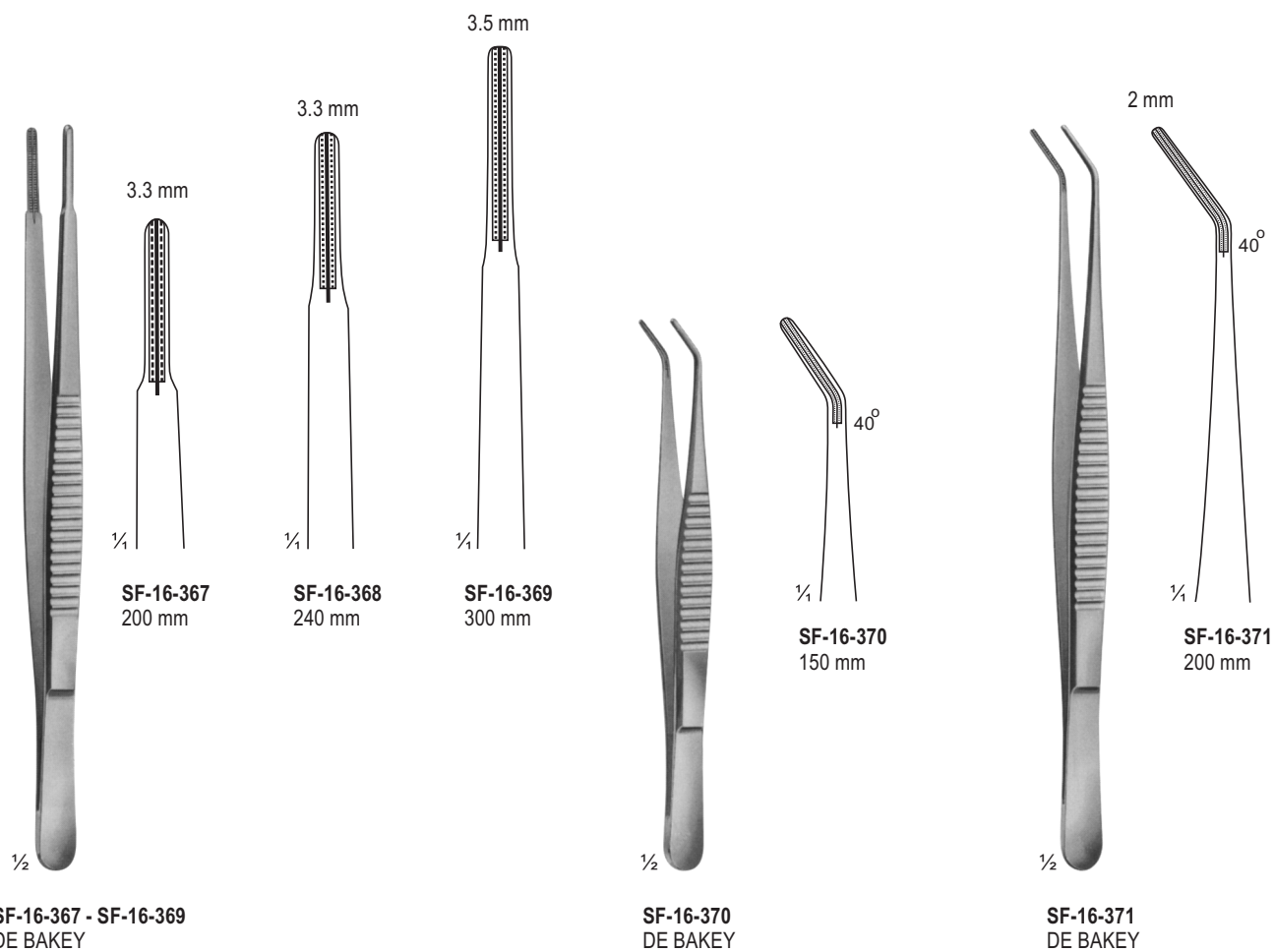

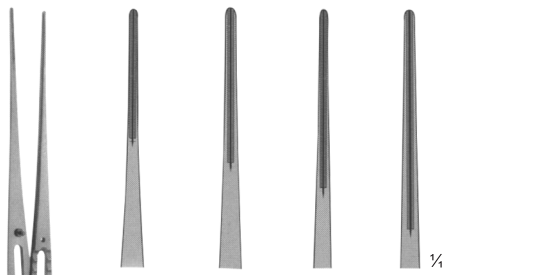

SF-16-372 1,2 mm
SF-16-373 1,5 mm
SF-16-374 1,5 mm
SF-16-375 1,5 mm

1/2

- SF-16-372** 150 mm
- SF-16-373** 200 mm
- SF-16-374** 240 mm
- SF-16-375** 300 mm

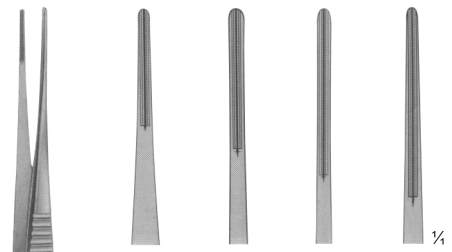

SF-16-376 2 mm
SF-16-377 2 mm
SF-16-378 2 mm
SF-16-379 2 mm

1/2

- DE BAKEY
- SF-16-376** 150 mm
 - SF-16-377** 200 mm
 - SF-16-378** 240 mm
 - SF-16-379** 300 mm



SF-16-380 2,8 mm
SF-16-381 2,8 mm
SF-16-382 2,8 mm
SF-16-383 2,8 mm

1/2

- DE BAKEY
- SF-16-380** 150 mm
 - SF-16-381** 200 mm
 - SF-16-382** 240 mm
 - SF-16-383** 300 mm

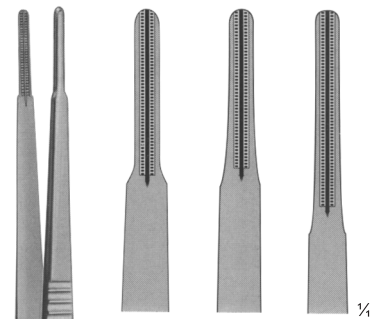

SF-16-384 3,3 mm
SF-16-385 3,3mm
SF-16-386 3,3mm

1/2

- DE BAKEY
- SF-16-384** 200 mm
 - SF-16-385** 240 mm
 - SF-16-386** 300 mm

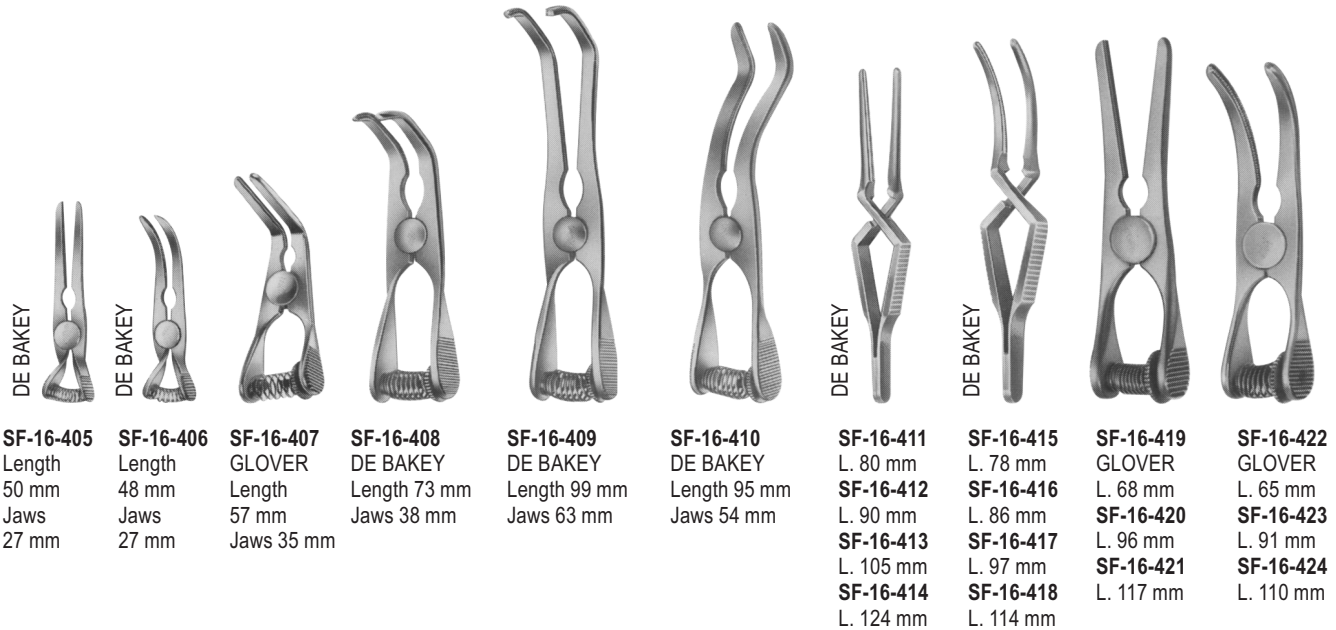
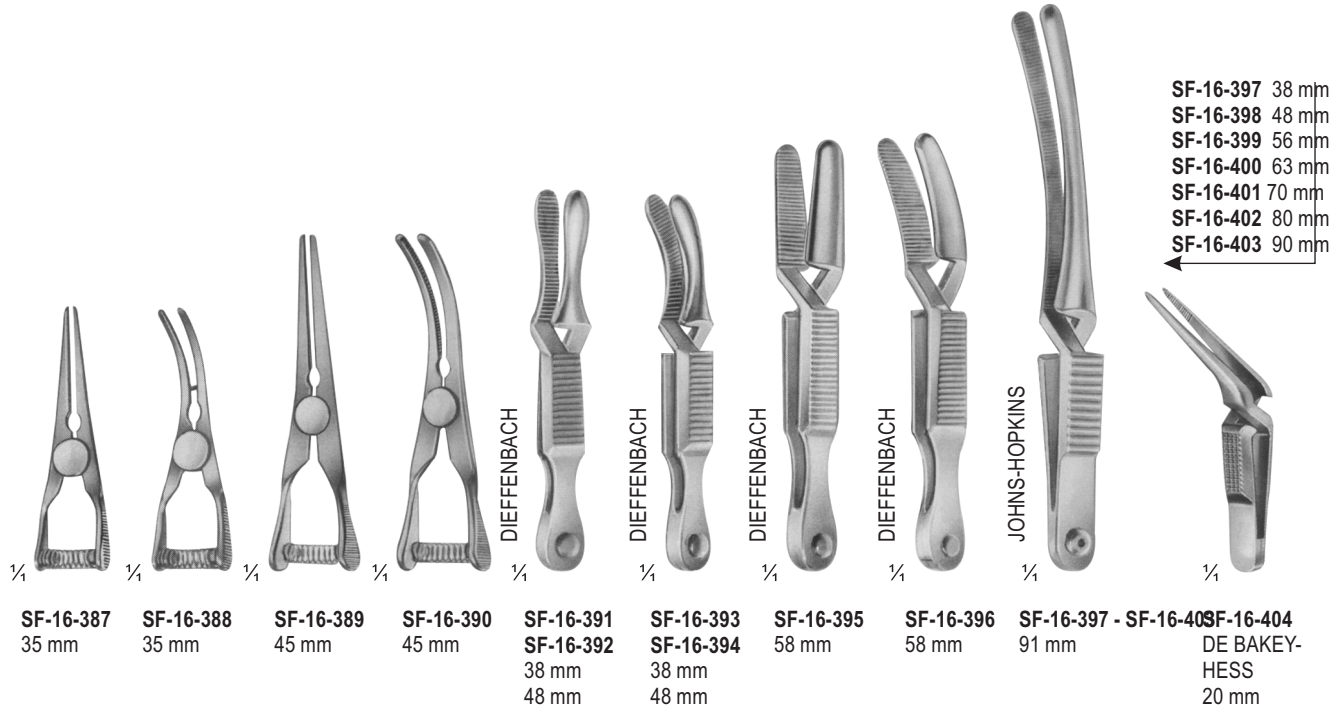

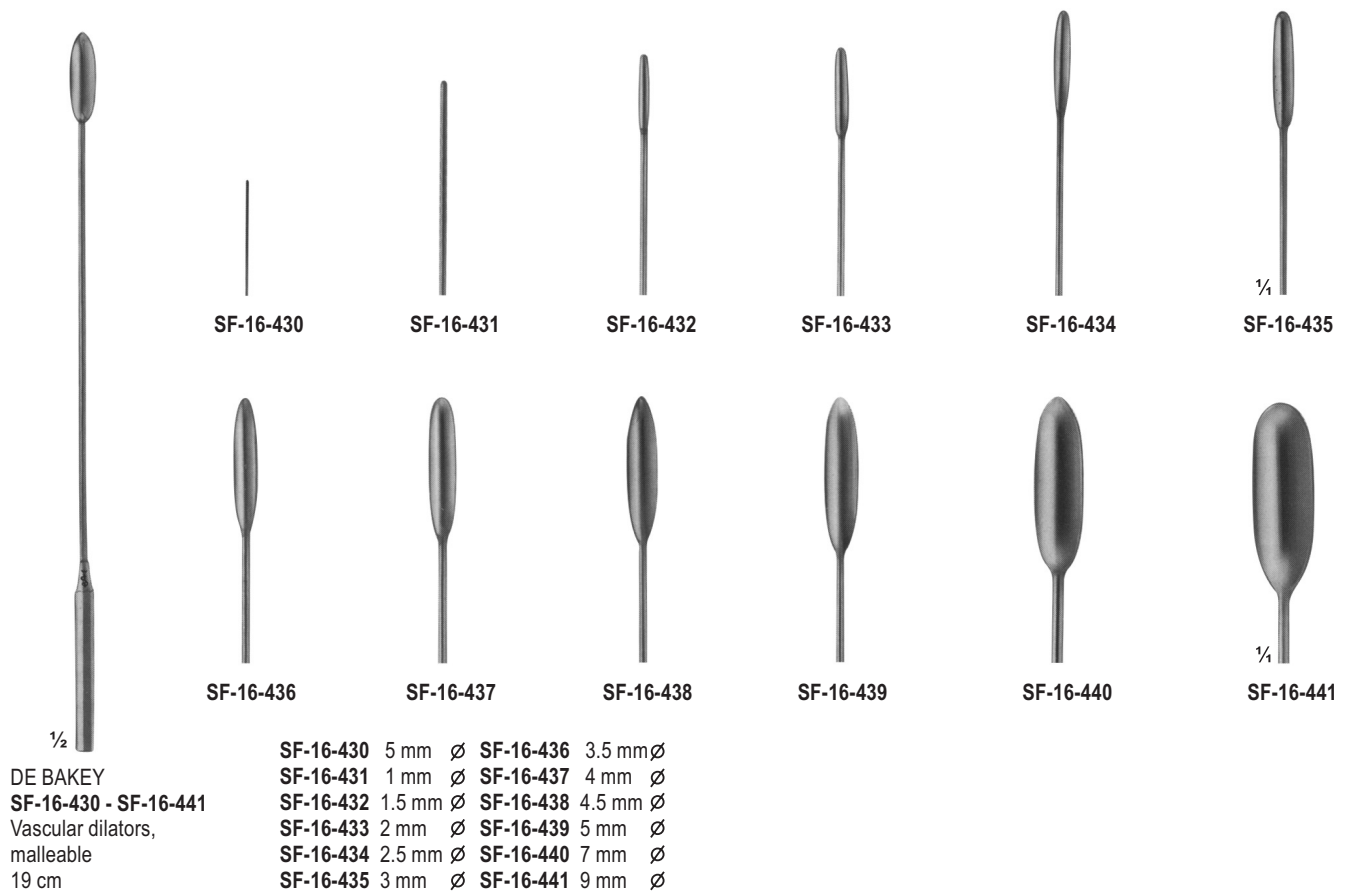
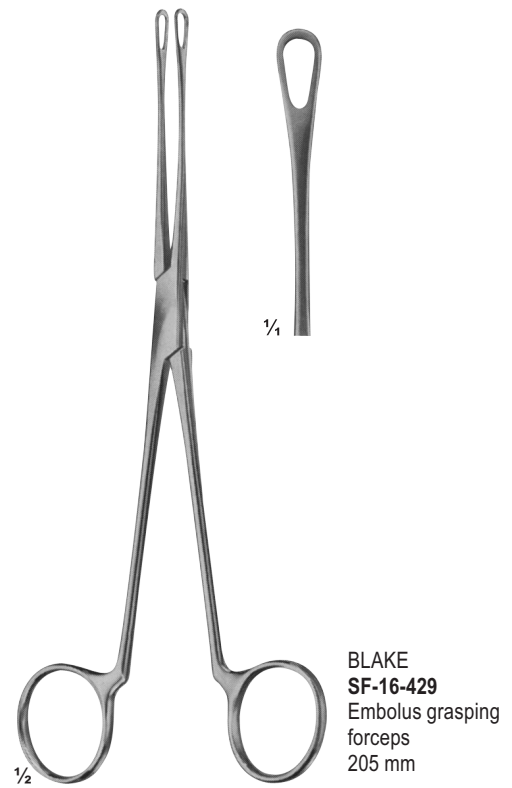
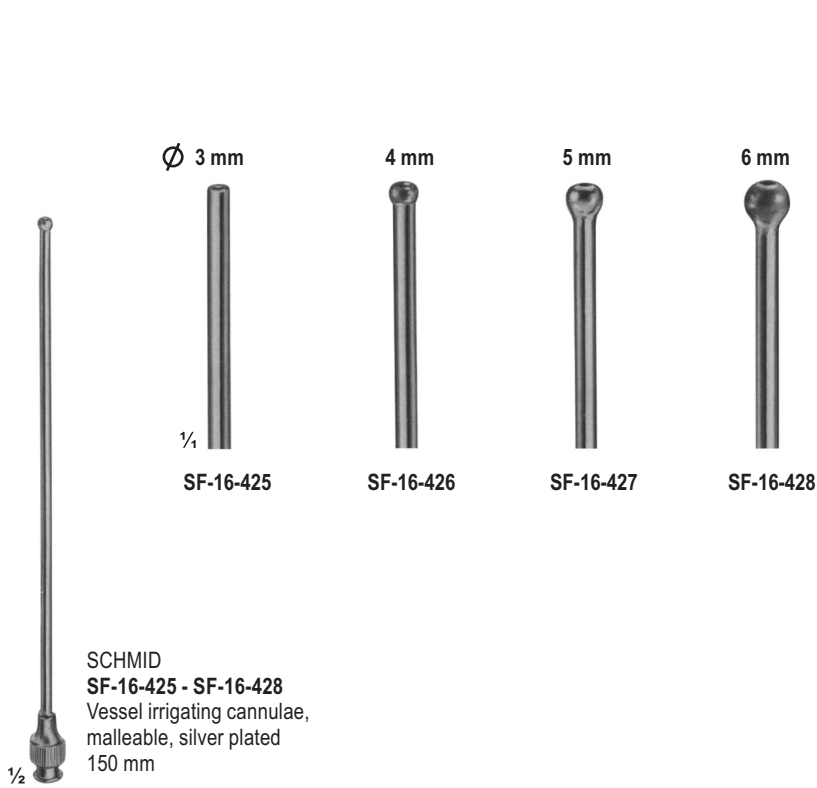

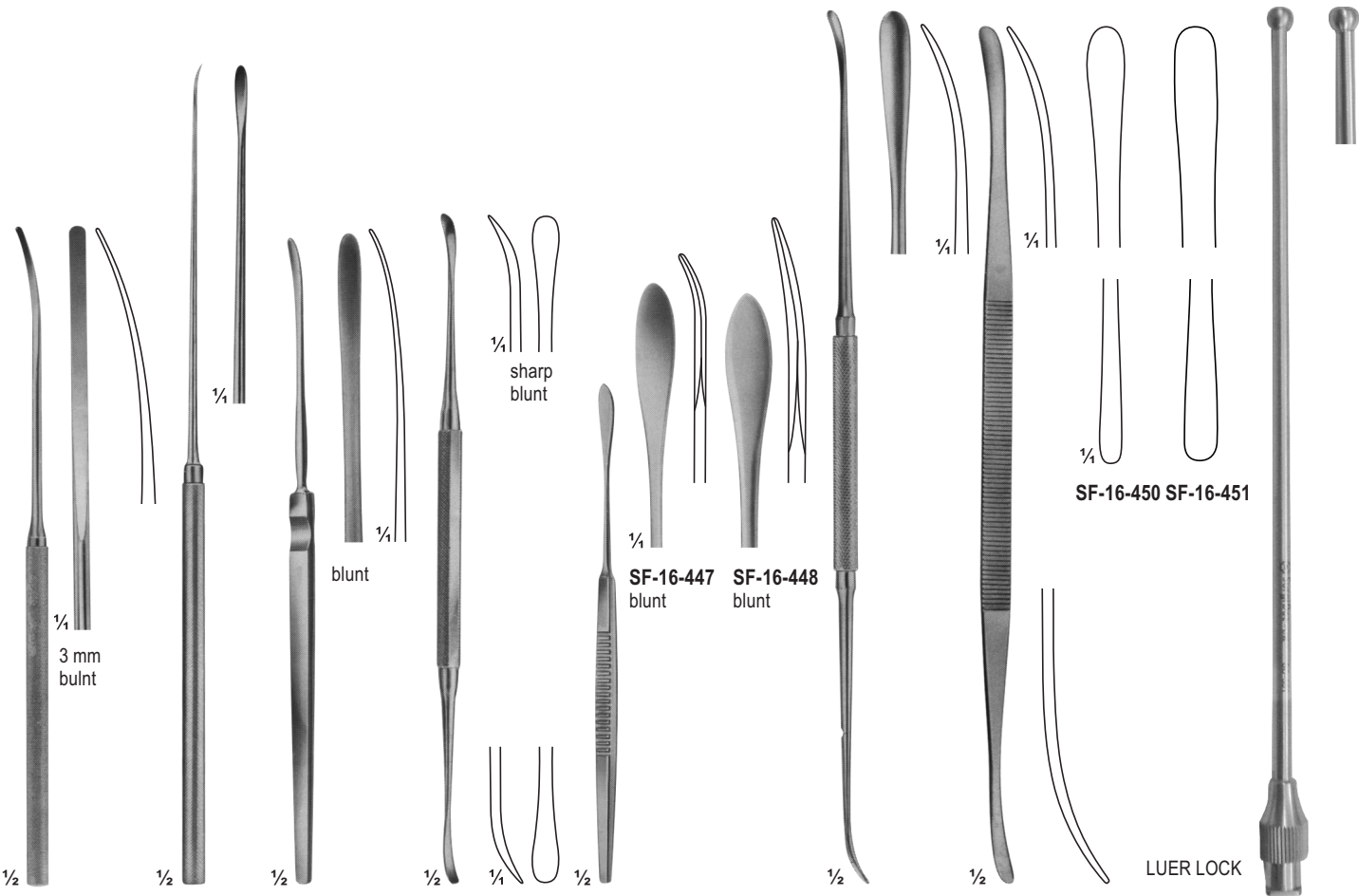

SF-16-442
180 mm
SF-16-443
215 mm

SF-16-444
230 mm

SF-16-445
HALLE
180 mm

SF-16-446
FREER
sharp/blunt
185 mm

SF-16-447 - SF-16-448
SCHMID
140 mm
235 mm

SF-16-449
DAVIS
245 mm

SF-16-450 - SF-16-451
TONNIS
240 mm

SF-16-452
SCHMID
Vessel Irrigating
Cannulae
150 mm, 6"
3, 4, 5, 6 mm

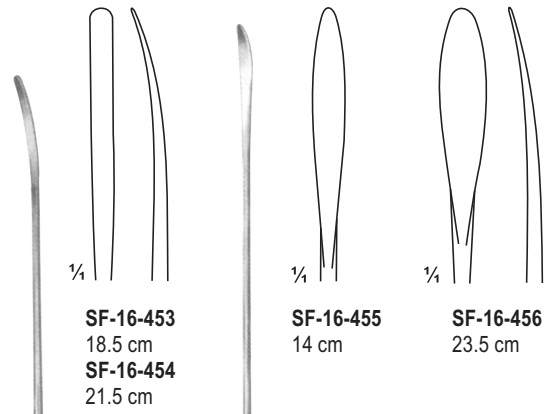

SF-16-453 - SF-16-454 **SF-16-455 - SF-16-456**

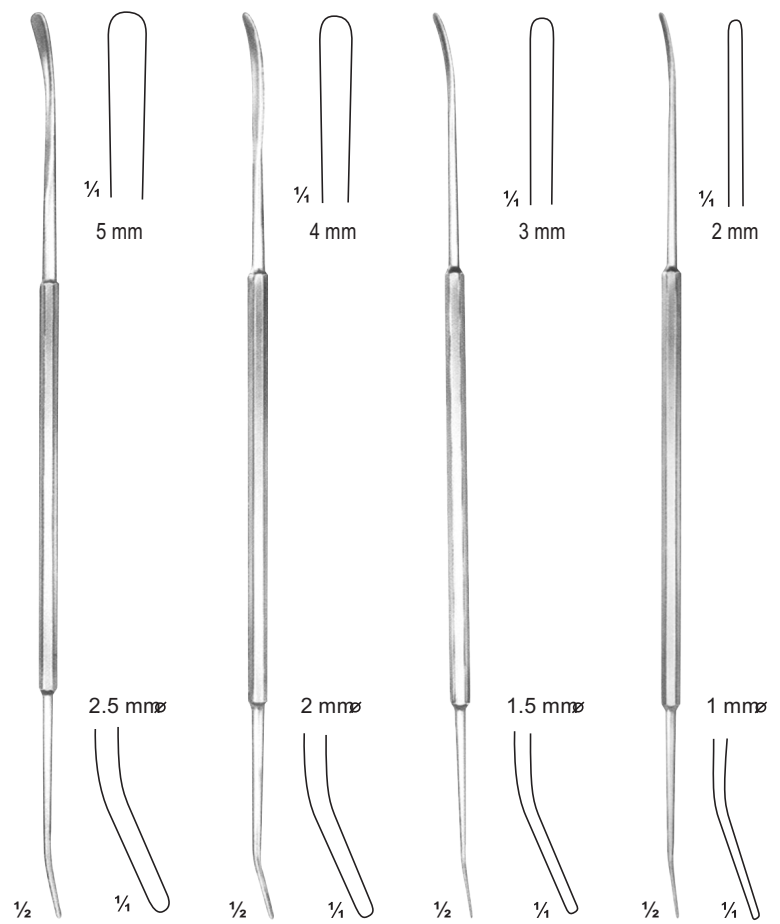

Fig. 1
ROBB
SF-16-457
24 cm

Fig. 2
ROBB
SF-16-458
24 cm

Fig. 3
ROBB
SF-16-459
24 cm

Fig. 4
ROBB
SF-16-460
24 cm



CRILE
SF-16-461
20 cm



CRILE
SF-16-462
20.5 cm



SF-16-463 - SF-16-466
26 cm

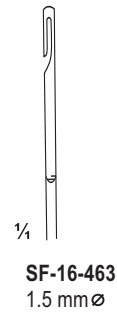

SF-16-463
1.5 mm ø

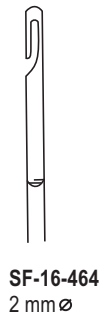

SF-16-464
2 mm ø

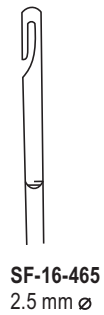

SF-16-465
2.5 mm ø

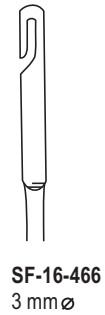

SF-16-466
3 mm ø

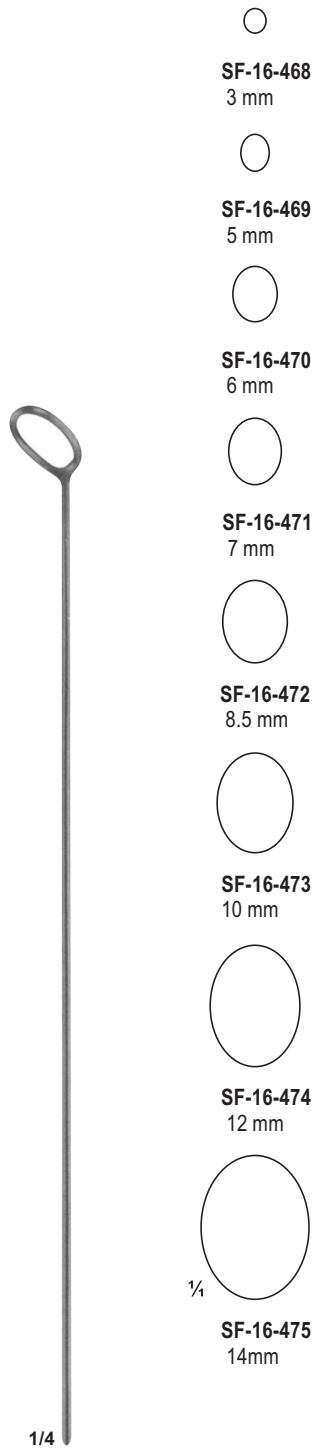

SF-16-467 - SF-16-475
Endarterectomy strippers
55 cm

○
SF-16-468
3 mm

○
SF-16-469
5 mm

○
SF-16-470
6 mm

○
SF-16-471
7 mm

○
SF-16-472
8.5 mm

○
SF-16-473
10 mm

○
SF-16-474
12 mm

○
SF-16-475
14mm



SF-16-476
Handle for
11 cm

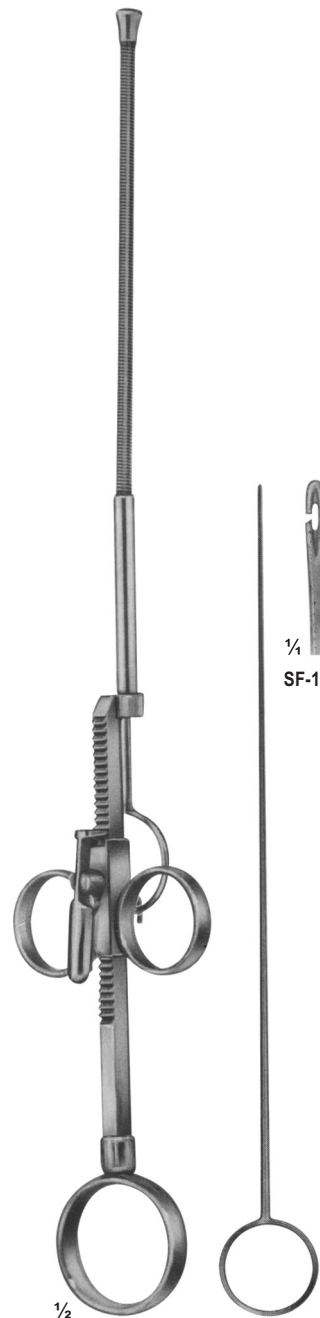

RUMEL-BELBONT
SF-16-477 - SF-16-478
32.5 cm
SF-16-477 - 4 mm Ø
SF-16-478 - 6.4 mm Ø

SF-16-479 SF-16-480

SF-16-479 - SF-16-480
Guide only

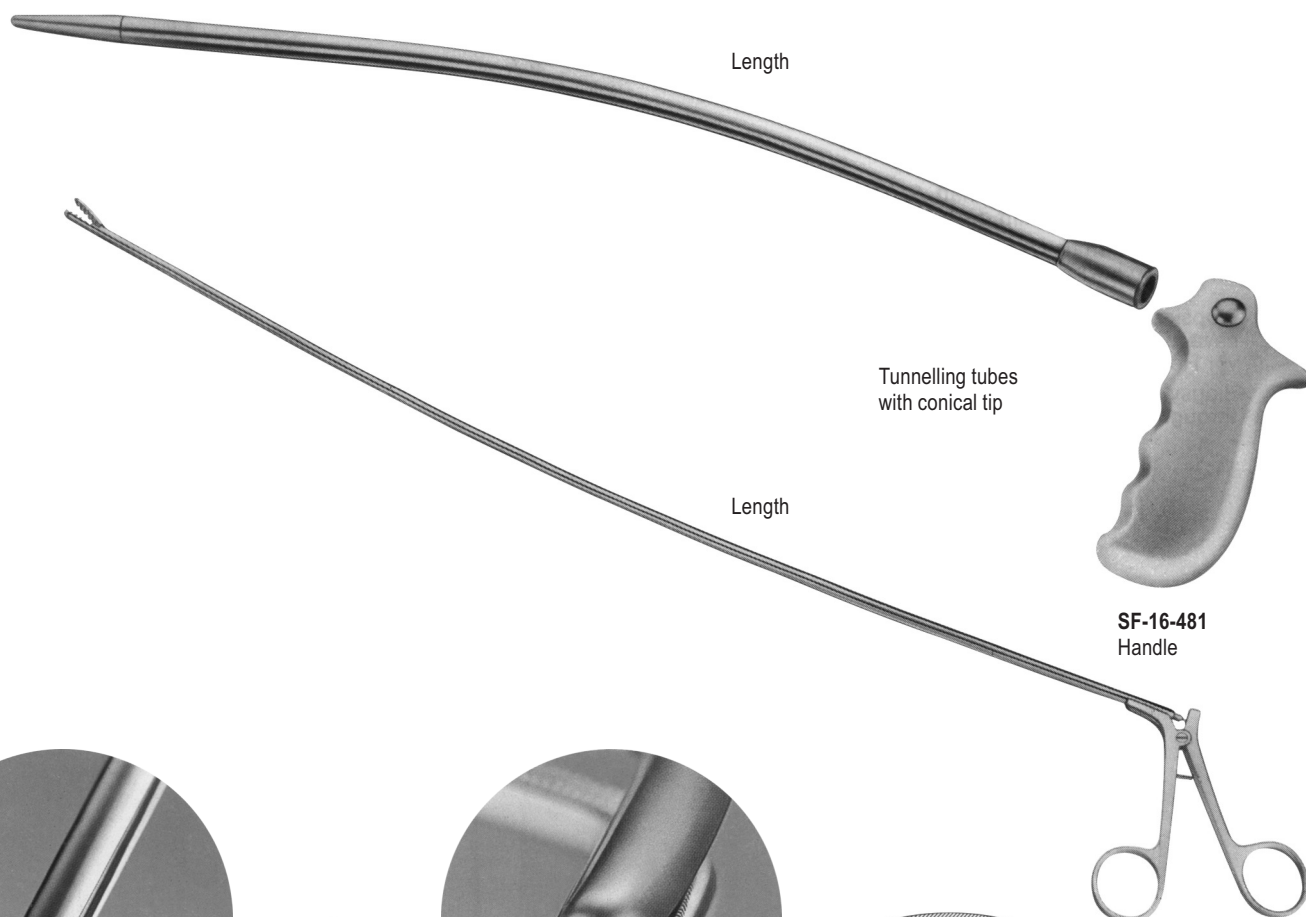

SF-16-481
Handle

SF-16-482 - SF-16-485
Forceps

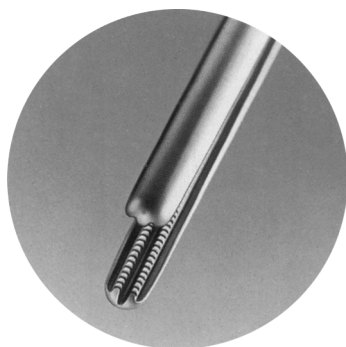

DE BAKEY
SF-16-482
1 : 2 rows of teeth

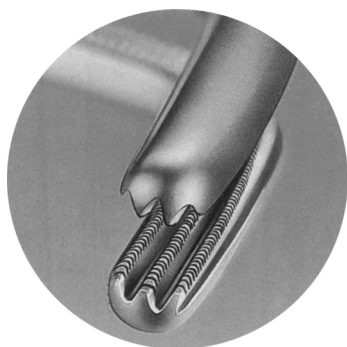
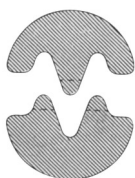

DE BAKEY
SF-16-483
2 : 3 rows of teeth

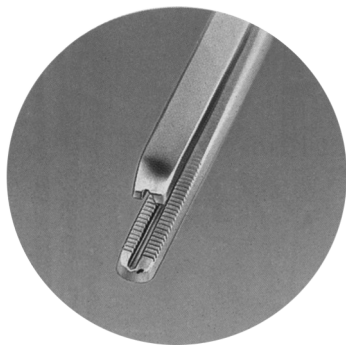
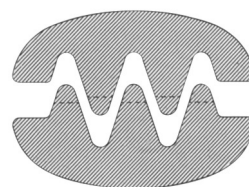

COOLEY
SF-16-484
2 : 2 rows of teeth

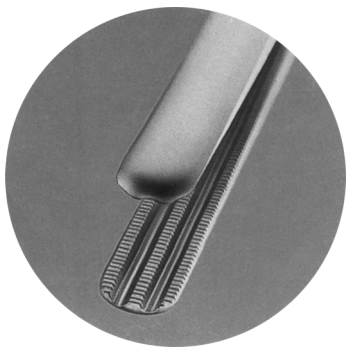
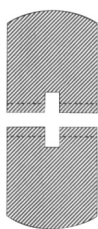

DARDIK
SF-16-485
2 : 3 rows of teeth

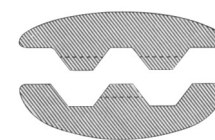

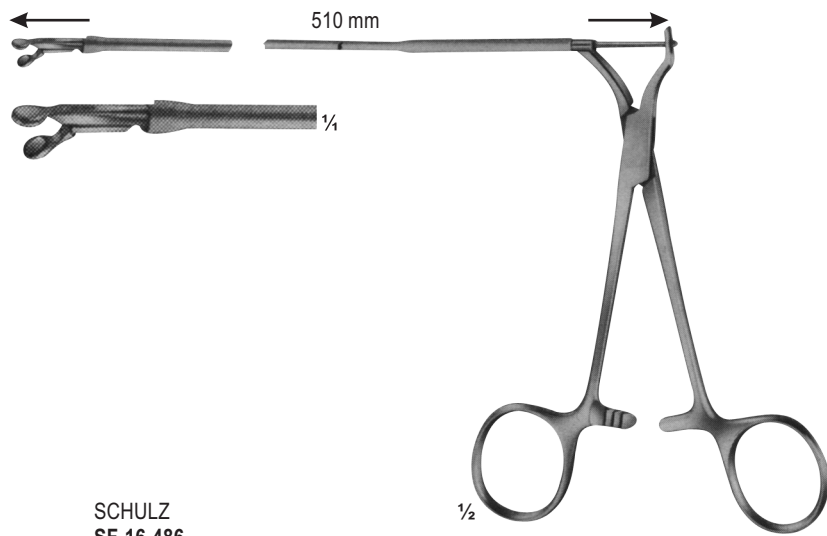

SCHULZ
SF-16-486

Bioptome, mit flexiblem Schaft, 510 mm lang,
with round jaws 3 mm diam.

Biopsy forceps, for biopsy from the right atrium
through cava juglaris, prior to heart implantations.

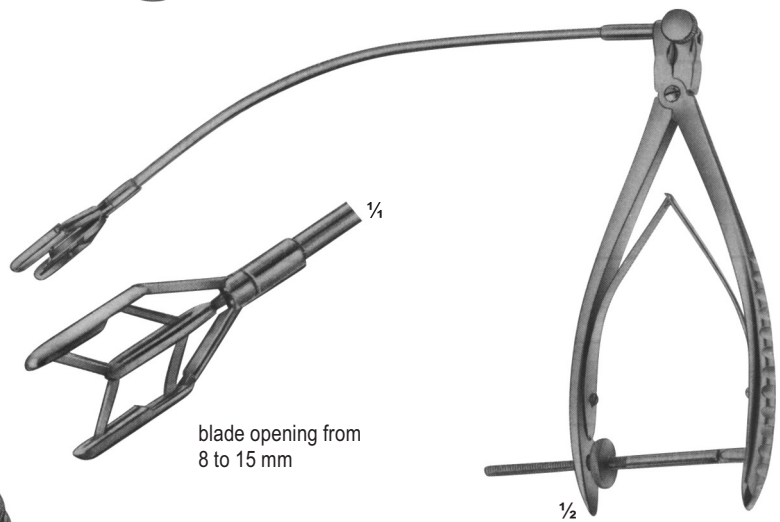

COOLEY
SF-16-487

Dilator for
mitral valve
for children

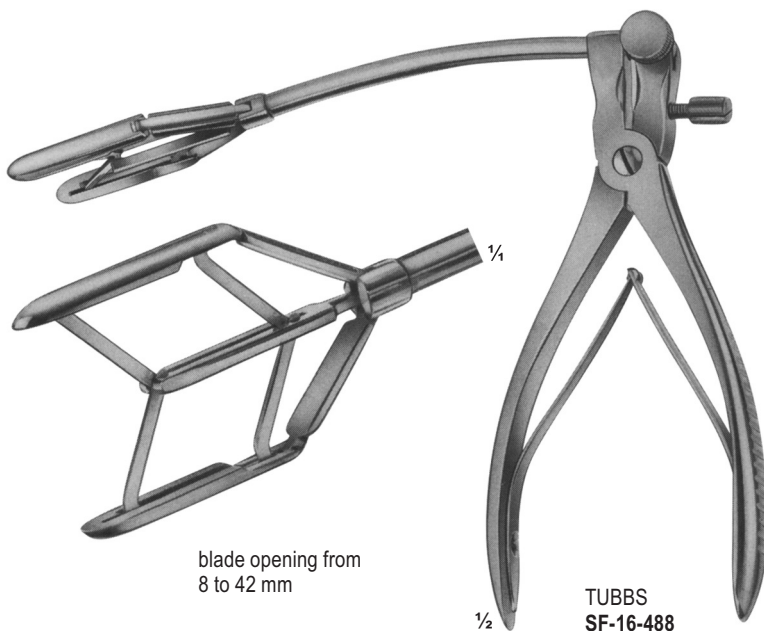

TUBBS
SF-16-488
Dilator for
mitral valve

blade opening from
8 to 42 mm

blade opening from
8 to 15 mm



1/2 SCHUMACHER
Sternum shears
SF-16-489
210 mm



1/3 GIERTZ-STILLE
SF-16-490
250 mm



1/2 GLUCK
SF-16-491
190 mm



1/3 BRUNNER
Universal Pattern
SF-16-492
340 mm

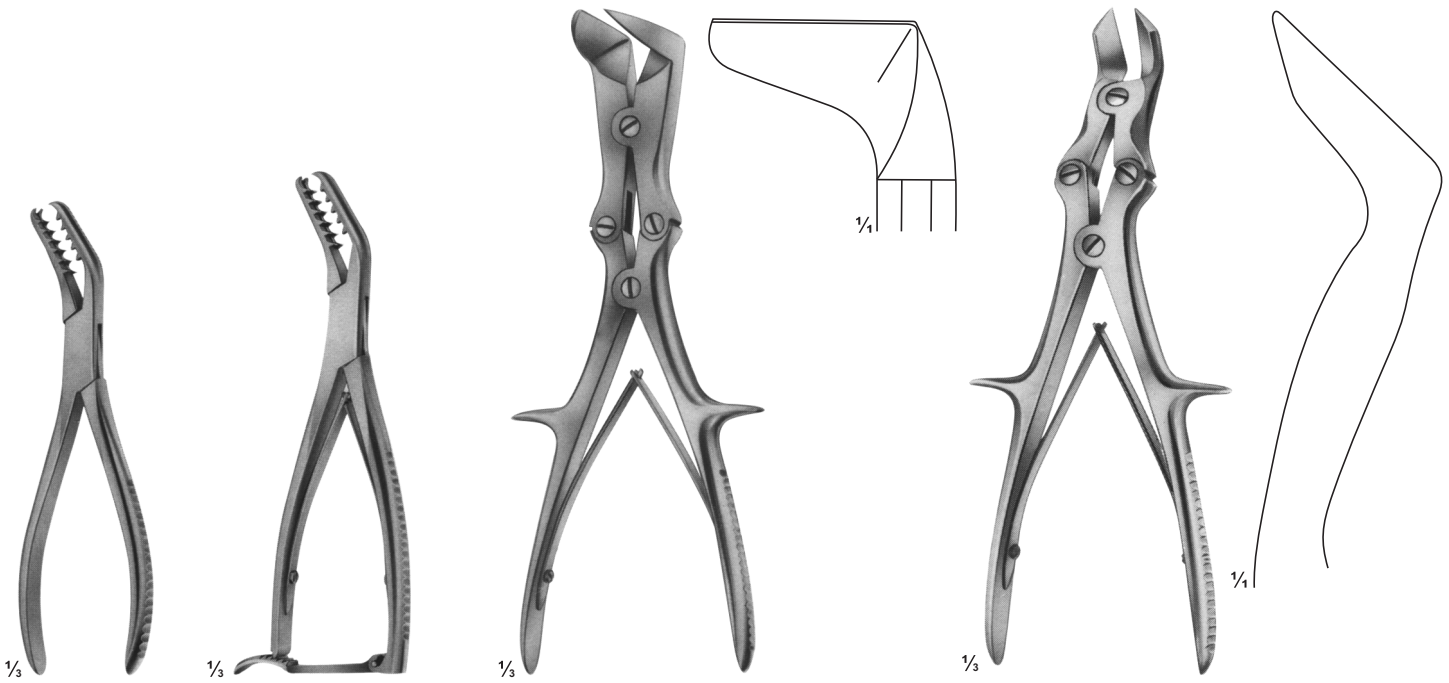

SF-16-493
SEMB
Rib-and Bone
Holding forceps
190 mm

SF-16-494
SEMB
Rib-and Bone
Holding forceps
190 mm

SF-16-495
LISTON-STILLE
265 mm

SF-16-496
LISTON-KEY-HORSLEY
255 mm

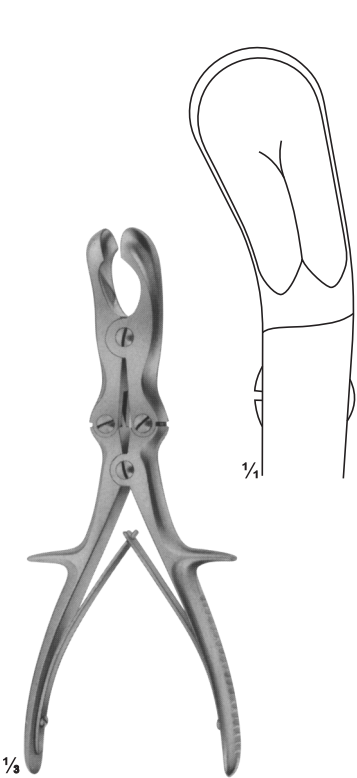

SF-16-497
SEME
Rib Rongeur to shorten
the rib stumps
240 mm

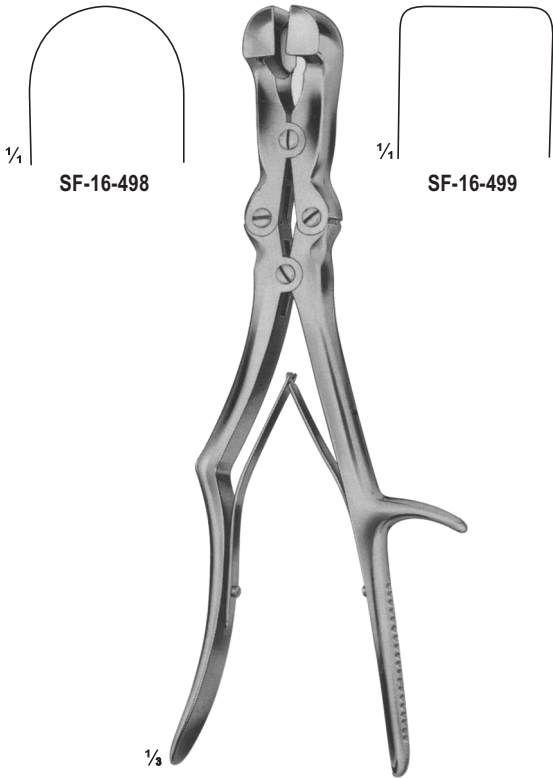

SF-16-498 - SF-16-499
SAUERDRUCH-CORYLLOS
Rib rongeurs to shortn
the rib stumbes
310 mm

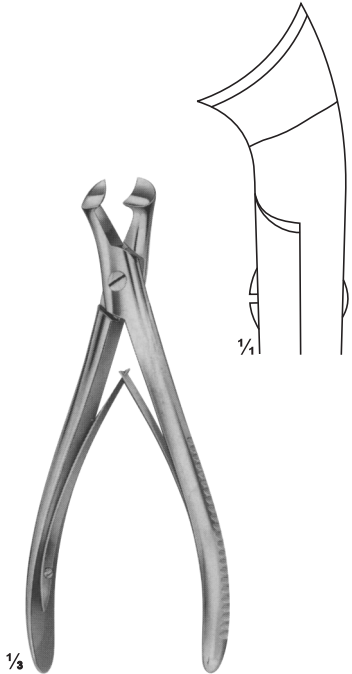

SF-16-500
MARKWALDER
Rib Rongeur to Round
the rib stumps
190 mm

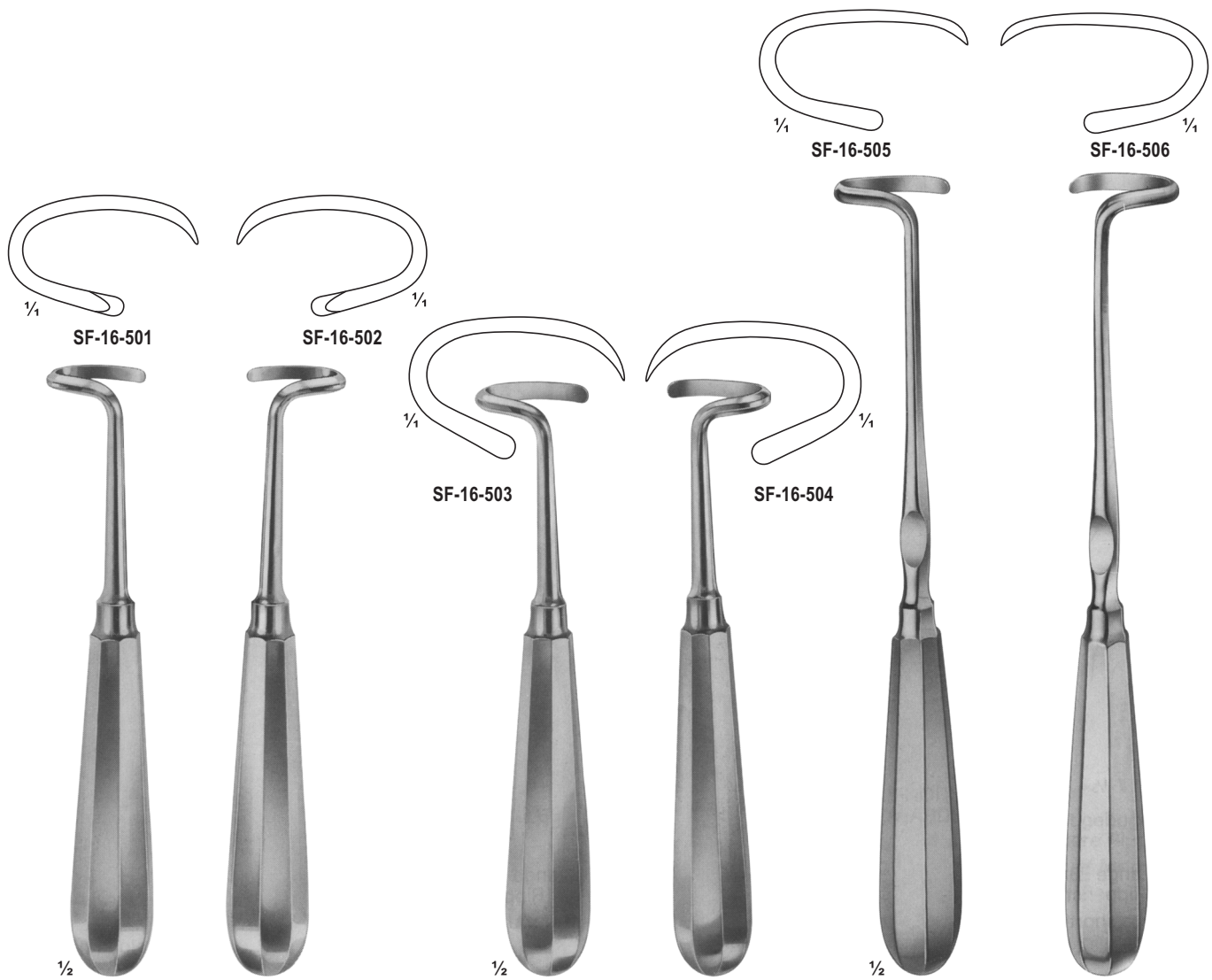

SF-16-501 - SF-16-502
DOYEN
for children
175 mm

SF-16-503 - SF-16-504
DOYEN
for adults
175 mm

SF-16-505 - SF-16-506
DOYEN
240 mm

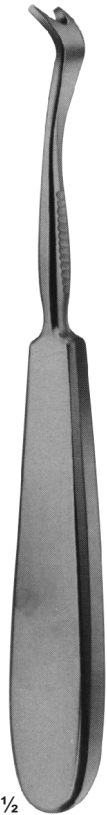

1/2
SF-16-507 - SF-16-511
SEMB
230 mm

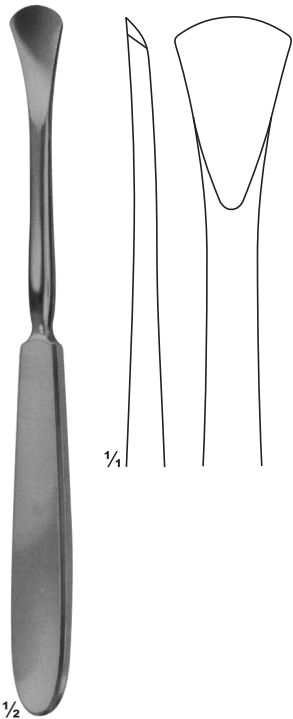
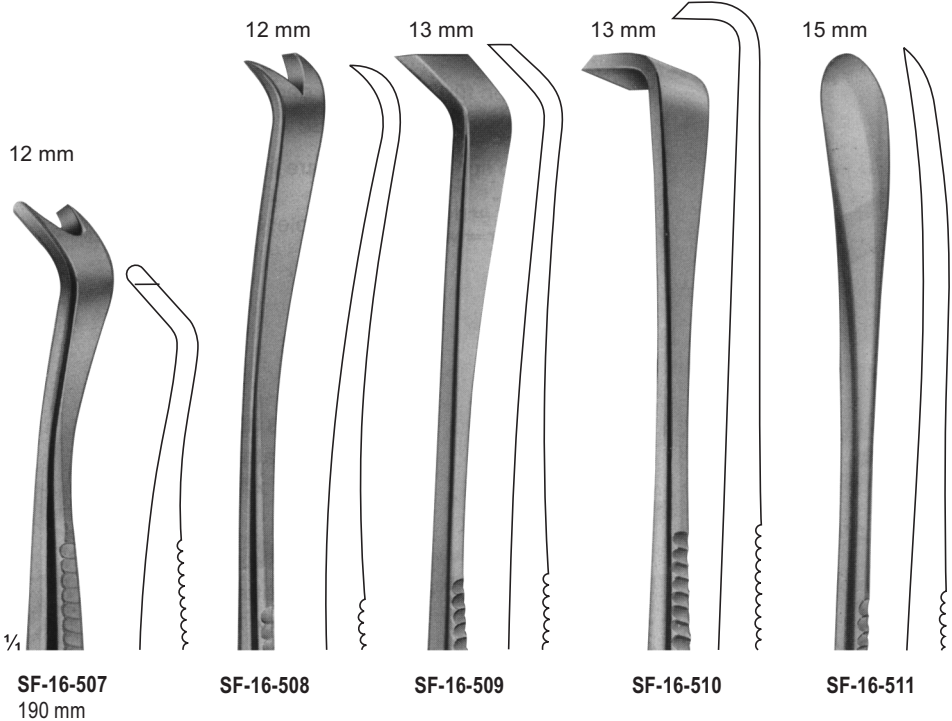

1/2
SF-16-512
LANGENBECK
190 mm

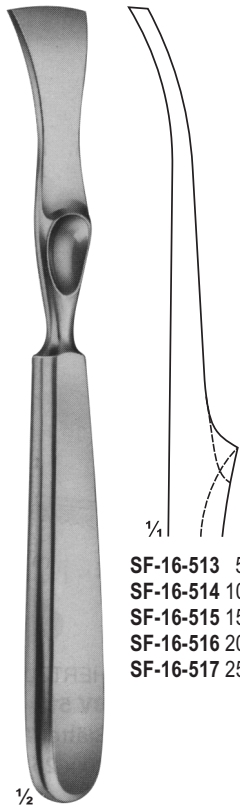

1/2
SF-16-513 - SF-16-517
LAMBOTTE
215 mm

- SF-16-513** 5 mm
- SF-16-514** 10 mm
- SF-16-515** 15 mm
- SF-16-516** 20 mm
- SF-16-517** 25 mm

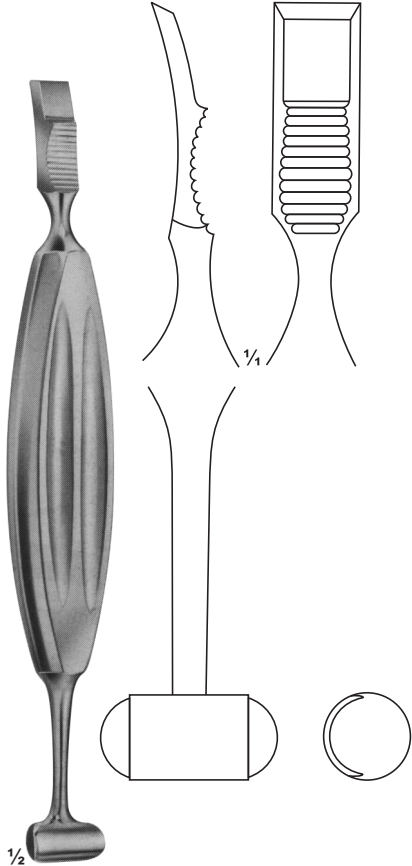

1/2
SF-16-518
ALEXANDER
210 mm



Surgiforce Instruments



Opposite Surgical Association,
Malkay Kalan, Marala Road,
Sialkot-51050 Pakistan.



+92 523 559131



info@surgiforce.com
sales@surgiforce.com



www.surgiforce.com



Our Certifications:

ISO 9001

CE Certified

EN 13485:2012

ISO 7153-1

ISO 7151

ISO 17664:2004

ISO 13402

ISO 15223

