

Page  
471-499

- NeuroSurgery
- Laminectomy

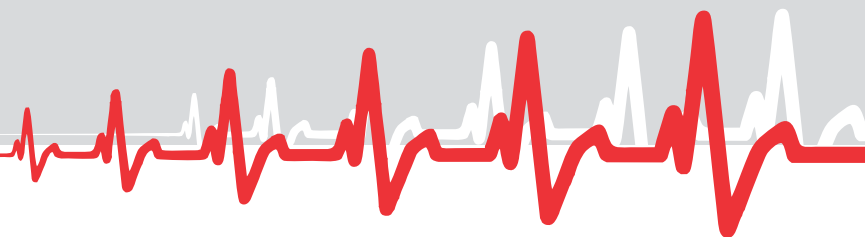



SF-21-101



SF-21-102



SF-21-103



SF-21-104

WAGENER  
SF-21-101 - SF-21-104  
150 mm



SF-21-105



SF-21-106



SF-21-107

GRAEFE  
SF-21-105 - SF-21-107  
140 mm



BROM  
SF-21-108  
Vein hook  
170 mm



1/4



CRILE  
SF-21-109  
200 mm



1/4



CUSHING  
SF-21-110- SF-21-111  
190 mm



SF-21-110



SF-21-111

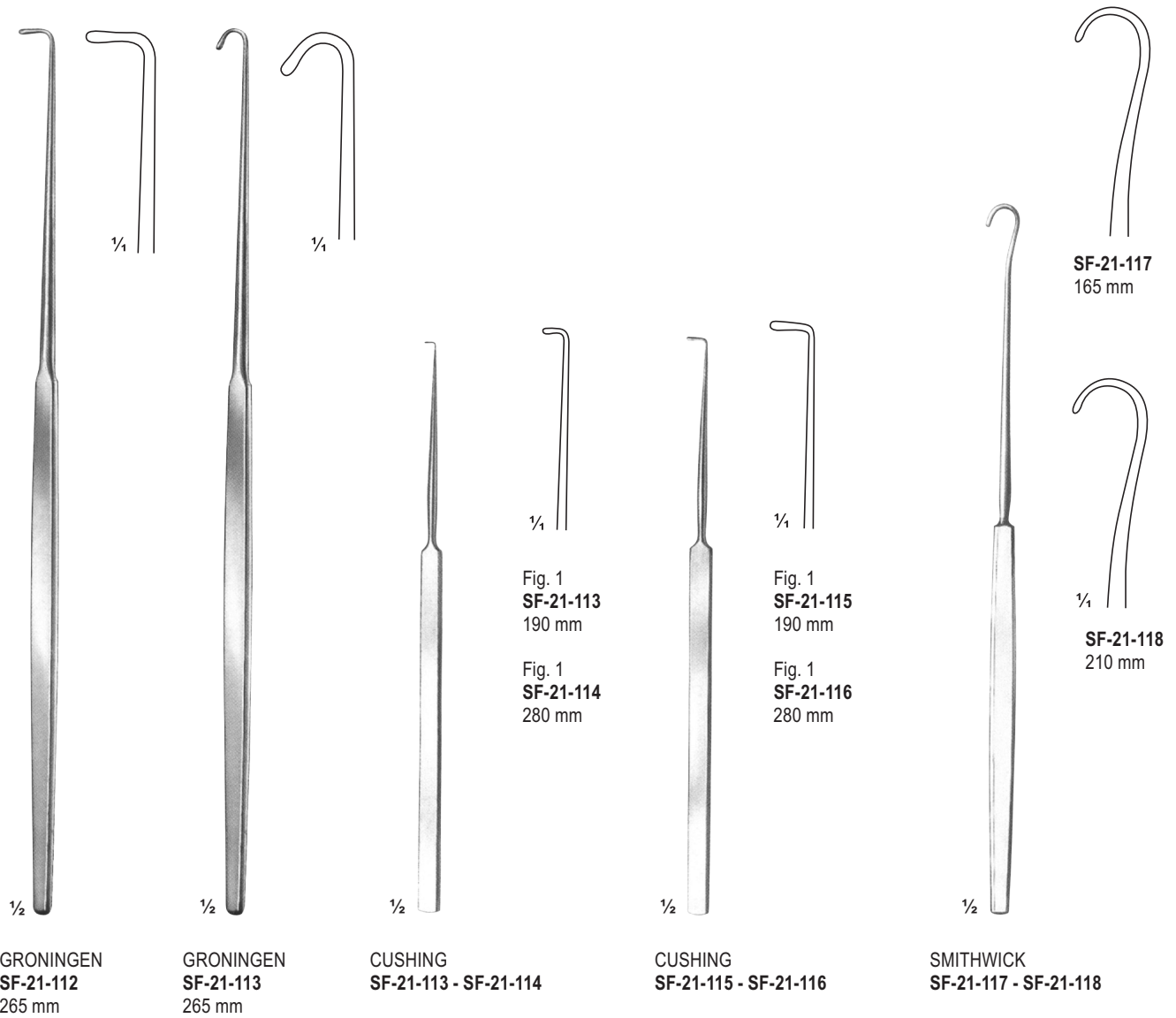



1/2  
KRAYENBUHI  
SF-21-119 - SF-21-122  
190 mm



Fig.1  
SF-21-119

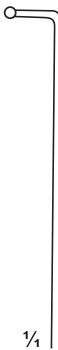

Fig.2  
SF-21-120



Fig.1  
SF-21-121



Fig.2  
SF-21-122



1/2  
CASPER  
SF-21-123 - SF-21-126  
245 mm



SF-21-123



SF-21-124



SF-21-125



SF-21-126



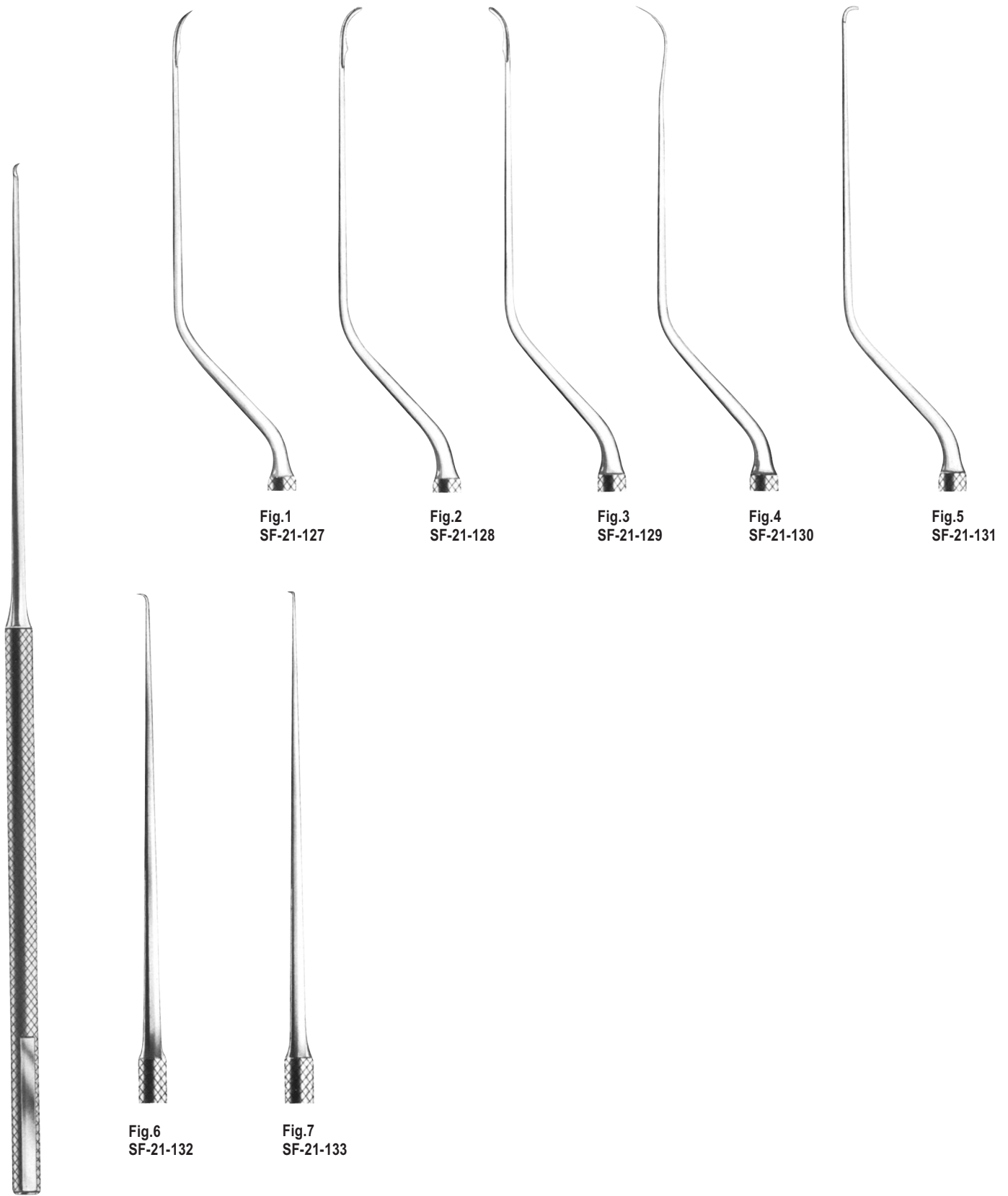

SF-21-127 - SF-21-133

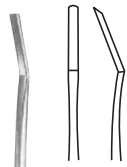

YASARGIL  
SF-21-134  
190 mm

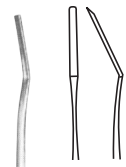

YASARGIL  
SF-21-135  
190 mm

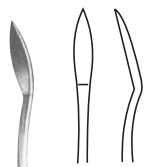

YASARGIL  
SF-21-136  
190 mm



YASARGIL  
SF-21-137  
190 mm

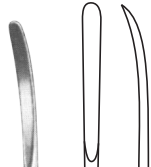

YASARGIL  
SF-21-138  
190 mm



YASARGIL  
SF-21-139  
190 mm



JACOBSON  
SF-21-140  
190 mm



JACOBSON  
SF-21-141  
190 mm



YASARGIL  
SF-21-142  
190 mm



SF-21-143  
190 mm

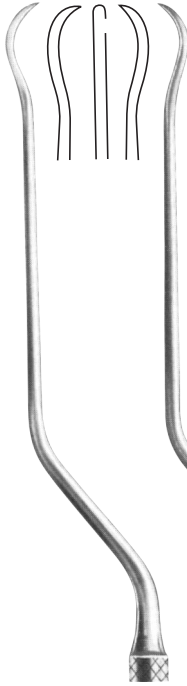

SF-21-144  
190 mm

YASARGIL



SF-21-145  
190 mm



SF-21-146  
190 mm

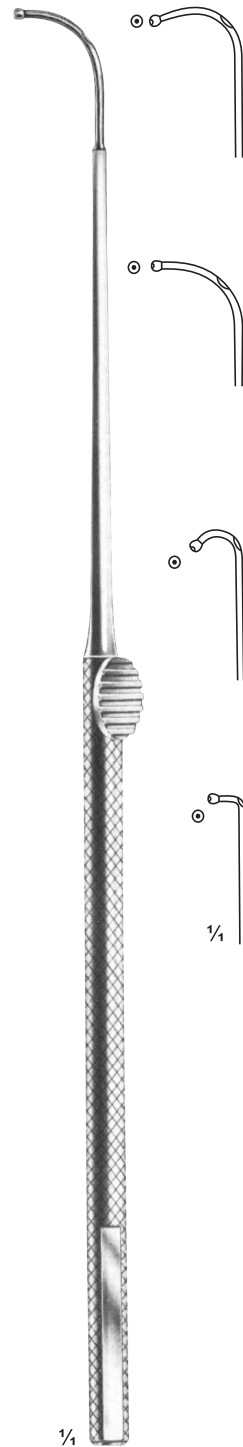

YASARGIL  
SF-21-SF-21-147  
190 mm



YASARGIL  
SF-21-148 - SF-21-149  
Galea Hook



SF-21-148  
300 mm



1/4  
SF-21-149  
410 mm

1/2



TOENNIS  
SF-21-150  
240 mm



1/4



OLIVECRONA  
SF-21-151  
240 mm



1/2



1/4



HESS  
Nerve Root Retractor  
**SF-21-152 - SF-21-154**  
**SF-21-152** 175 mm 3 mm  
**SF-21-153** 175 mm 5 mm  
**SF-21-154** 175 mm 7 mm

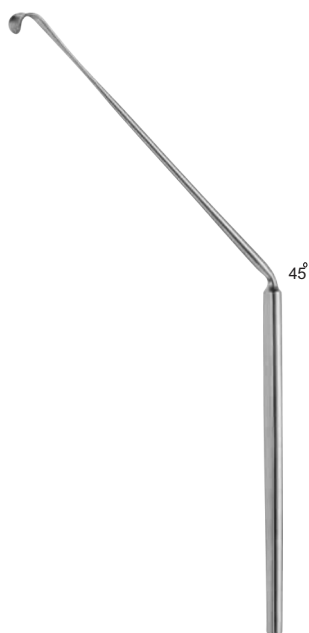

LOVE  
Nerve Root Retractor  
**SF-21-155 - SF-21-157**  
**SF-21-155** 190 mm 30°  
**SF-21-156** 190 mm 45°  
**SF-21-157** 190 mm 90°



CASPAR  
Nerve Root Retractor  
**SF-21-158 - SF-21-160**  
**SF-21-158** 245 mm 6 mm  
**SF-21-159** 245 mm 8 mm  
**SF-21-160** 245 mm 10 mm



LOVE  
**SF-21-161**  
210 mm

# NERVE ROOT RETRACTORS

[www.surgiforce.com](http://www.surgiforce.com)

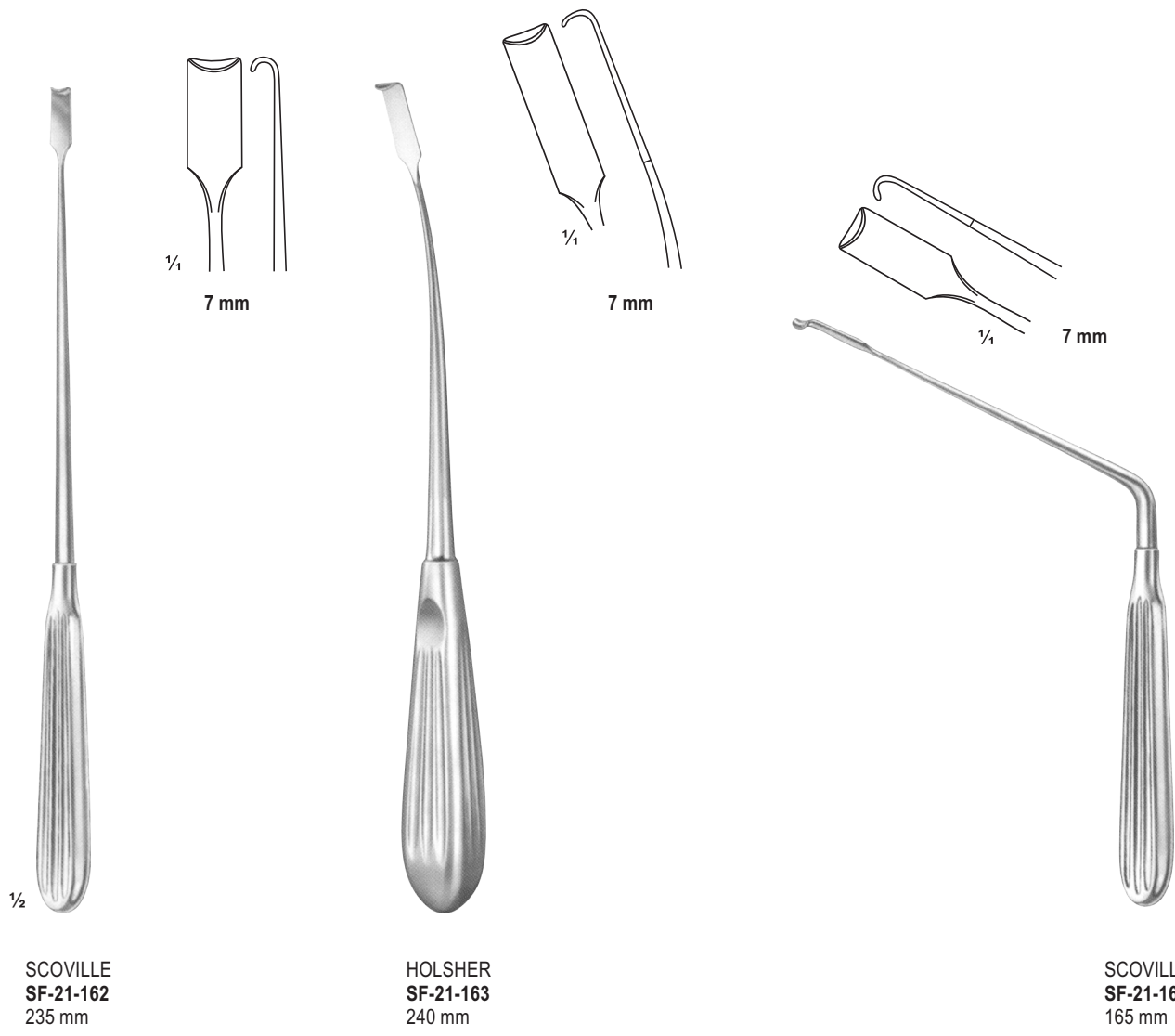

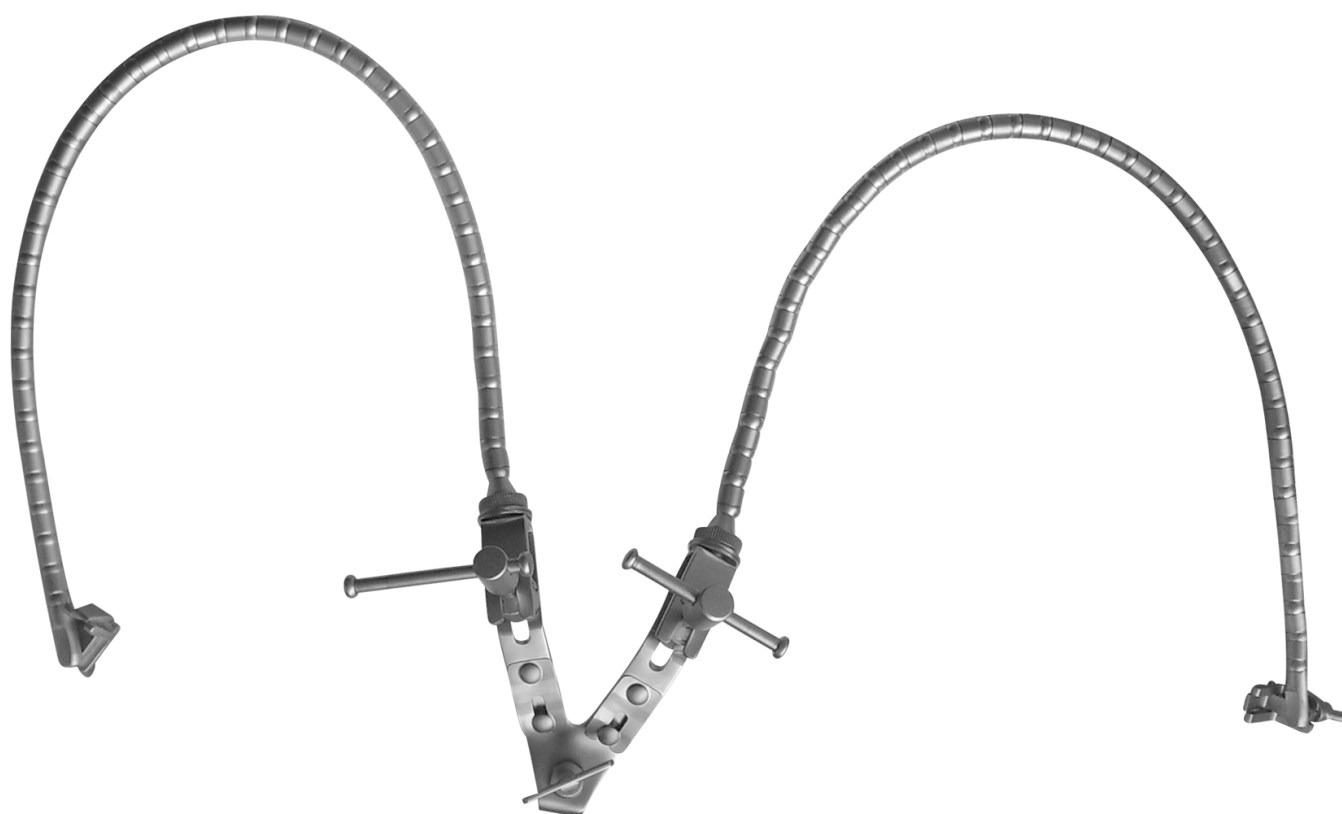

LEYLA  
**SF-21-165**  
Self-Retaining brain retractor  
with 2 arms complete

LEYLA BED RETRACTOR  
**SF-21-166**  
Self-Retaining brain retractor  
bed retractor not illustrated

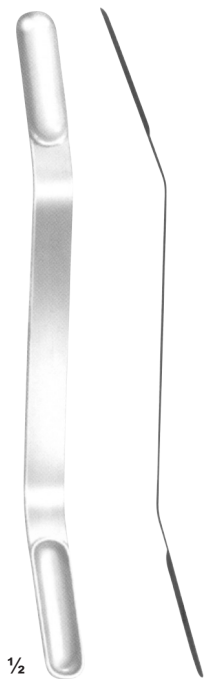

OLIVECRONA  
**SF-21-167 - SF-21-170**  
 180 mm  
 Concave

**SF-21-167** 7 + 9 mm  
**SF-21-168** 11 + 13 mm  
**SF-21-169** 15 + 18 mm  
**SF-21-170** 18 + 22 mm



**SF-21-171**  
 15.5 cm  
 11 mm

**SF-21-172**  
 20 cm  
 14 mm

**SF-21-173**  
 20 cm  
 17 mm

**SF-21-174**  
 20 cm  
 20 mm

HEIFETZ  
**SF-21-171 - SF-21-174**

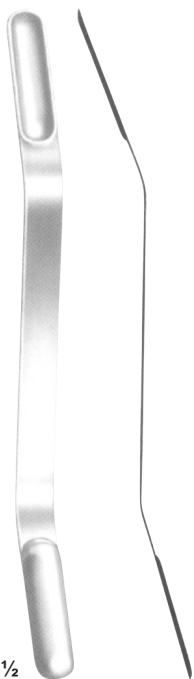

OLIVECRONA  
**SF-21-175 - SF-21-178**  
 180 mm  
 Convex

**SF-21-175** 7 + 9 mm  
**SF-21-176** 11 + 13 mm  
**SF-21-177** 15 + 18 mm  
**SF-21-178** 18 + 22 mm



**SF-21-179**  
 8 mm

**SF-21-180**  
 14 mm

**SF-21-181**  
 17 mm

HEIFETZ  
**SF-21-179 - SF-21-181**  
 155 mm



**CASPAR SF-21-182**  
Transverse Retractor hinged  
65 mm regular spread  
110 mm wide spread



**CASPAR SF-21-183**  
Transverse Retractor double-hinged  
65 mm spread



**CASPAR SF-21-184**  
Longitudinal Retractor  
double-hinged, ring handle  
205 mm  
85 mm spread



**CASPAR SF-21-185**  
Specula Retractor single-hinged,  
115 mm  
70mm regular spread



**SF-21-186 - SF-21-194**  
SF-21-187 23 x 35 mm  
SF-21-188 23 x 40 mm  
SF-21-189 23 x 45 mm  
SF-21-190 23 x 50 mm  
SF-21-191 23 x 55 mm  
SF-21-192 23 x 60 mm  
SF-21-193 23 x 65 mm  
SF-21-194 23 x 70 mm  
Medial Toothed Blades  
Stainless Steel



**SF-21-195 - SF-21-199**  
SF-21-195 15 x 40 mm  
SF-21-196 15 x 45 mm  
SF-21-197 15 x 50 mm  
SF-21-198 15 x 55 mm  
SF-21-199 15 x 60 mm  
Small Lateral Blades  
Stainless Steel



**SF-21-200 - SF-21-206**  
SF-21-200 23 x 40 mm  
SF-21-201 23 x 45 mm  
SF-21-202 23 x 50 mm  
SF-21-203 23 x 55 mm  
SF-21-204 23 x 60 mm  
SF-21-205 23 x 65 mm  
SF-21-206 23 x 70 mm  
Lateral Serrated Blades  
Stainless Steel



**Cervical Blades**  
Stainless Steel – fenestrated  
SF-21-207 - SF-21-208  
SF-21-207 25 x 50 mm  
SF-21-208 25 x 60 mm



**SF-21-209 - SF-21-217**  
SF-21-209 23 x 35 mm  
SF-21-210 23 x 40 mm  
SF-21-211 23 x 45 mm  
SF-21-212 23 x 50 mm  
SF-21-213 23 x 55 mm  
SF-21-214 23 x 60 mm  
SF-21-215 23 x 65 mm  
SF-21-216 23 x 70 mm  
SF-21-217 23 x 75 mm  
Blunt Blades  
Stainless Steel



**SF-21-218 - SF-21-222**  
SF-21-218 23 x 40 mm  
SF-21-219 23 x 45 mm  
SF-21-220 23 x 50 mm  
SF-21-221 23 x 55 mm  
SF-21-222 23 x 60 mm  
Medial Toothed Blades  
Aluminium – rotatating



**SF-21-223 - SF-21-227**  
SF-21-223 23 x 40 mm  
SF-21-224 23 x 45 mm  
SF-21-225 23 x 50 mm  
SF-21-226 23 x 55 mm  
SF-21-227 23 x 60 mm  
Lateral Serrated Blades  
Aluminium – rotatating



**SF-21-228 - SF-21-232**  
SF-21-228 23 x 45 mm  
SF-21-229 23 x 50 mm  
SF-21-230 3 x 55 mm  
SF-21-231 23 x 60 mm  
SF-21-232 23 x 65 mm  
Blunt Blades  
Aluminium – rotatating





CASPAR  
SF-21-233  
Transverse Retractor hinged  
65 mm spread



CASPAR  
SF-21-234  
Specula Retractor single-hinged  
115 mm,  
70 mm spread



CASPAR  
SF-21-235  
Longitudinal Retractor  
single-hinged ring handle  
175 mm  
70 mm spread



SF-21-236 - SF-21-243  
SF-21-236 20 x 40 mm  
SF-21-237 20 x 45 mm  
SF-21-238 20 x 50 mm  
SF-21-239 20 x 55 mm  
SF-21-240 20 x 60 mm  
SF-21-241 20 x 65 mm  
SF-21-242 20 x 70 mm  
SF-21-243 20 x 75 mm  
Medial Toothed Blades



SF-21-244 - SF-21-254  
SF-21-244 20 x 25 mm  
SF-21-245 20 x 30 mm  
SF-21-246 20 x 35 mm  
SF-21-247 20 x 40 mm  
SF-21-248 20 x 45 mm  
SF-21-249 20 x 50 mm  
SF-21-250 20 x 55 mm  
SF-21-251 20 x 60 mm  
SF-21-252 20 x 65 mm  
SF-21-253 20 x 70 mm  
SF-21-254 20 x 75 mm  
Lateral Serrated Blades



SF-21-255 - SF-21-264  
SF-21-255 20 x 30 mm  
SF-21-256 20 x 35 mm  
SF-21-257 20 x 40 mm  
SF-21-258 20 x 45 mm  
SF-21-259 20 x 50 mm  
SF-21-260 20 x 55 mm  
SF-21-261 20 x 60 mm  
SF-21-262 20 x 65 mm  
SF-21-263 20 x 70 mm  
SF-21-264 20 x 75 mm  
Blunt Blades



SF-21-265 - SF-21-272  
SF-21-265 20 x 35 mm  
SF-21-266 20 x 40 mm  
SF-21-267 20 x 45 mm  
SF-21-268 20 x 50 mm  
SF-21-269 20 x 55 mm  
SF-21-270 20 x 60 mm  
SF-21-271 20 x 65 mm  
SF-21-272 0 x 70 mm  
Medial Toothed Blades  
fenestrated



SF-21-273 - SF-21-282  
SF-21-273 20 x 25 mm  
SF-21-274 20 x 30 mm  
SF-21-275 20 x 35 mm  
SF-21-276 20 x 40 mm  
SF-21-277 20 x 45 mm  
SF-21-278 20 x 50 mm  
SF-21-279 20 x 55 mm  
SF-21-280 20 x 60 mm  
SF-21-281 20 x 65 mm  
SF-21-282 20 x 70 mm  
Lateral Serrated Blades  
Fenestrated



SF-21-283 - SF-21-291  
SF-21-283 20 x 35 mm  
SF-21-284 20 x 40 mm  
SF-21-285 20 x 45 mm  
SF-21-286 20 x 50 mm  
SF-21-287 20 x 55 mm  
SF-21-288 20 x 60 mm  
SF-21-289 20 x 65 mm  
SF-21-290 20 x 70 mm  
SF-21-291 20 x 75 mm  
Blunt Blades Fenestrated



CASPAR  
**SF-21-292**  
Transverse Retractor hinged  
60 mm spread



CASPAR  
**SF-21-293**  
Transverse Retractor double-hinged  
65 mm spread



CASPAR  
**SF-21-294**  
Longitudinal Retractor  
single-hinged ring handle  
175 mm  
70 mm spread



CASPAR  
**SF-21-295**  
Longitudinal Retractor  
single-hinged ring handle  
175 mm  
70 mm spread



**SF-21-296 - SF-21-302**  
**SF-21-296** 12 x 40 mm  
**SF-21-297** 12 x 45 mm  
**SF-21-298** 12 x 50 mm  
**SF-21-299** 12 x 55 mm  
**SF-21-300** 12 x 60 mm  
**SF-21-301** 12 x 65 mm  
**SF-21-302** 12 x 75 mm  
 Small Lateral Serrated  
 Blades PEEK



**SF-21-303 - SF-21-309**  
**SF-21-303** 23 x 40 mm  
**SF-21-304** 23 x 45 mm  
**SF-21-305** 23 x 50 mm  
**SF-21-306** 23 x 55 mm  
**SF-21-307** 23 x 60 mm  
**SF-21-308** 23 x 65 mm  
**SF-21-309** 23 x 75 mm  
 Lateral Serrated Blades  
 PEEK



**SF-21-310 - SF-21-316**  
**SF-21-310** 23 x 40 mm  
**SF-21-311** 23 x 45 mm  
**SF-21-312** 23 x 50 mm  
**SF-21-313** 23 x 55 mm  
**SF-21-314** 23 x 60 mm  
**SF-21-315** 23 x 65 mm  
**SF-21-316** 23 x 75 mm  
 Blunt Blades PEEK



**SF-21-317 - SF-21-323**  
**SF-21-317** 23 x 40 mm  
**SF-21-318** 23 x 45 mm  
**SF-21-319** 23 x 50 mm  
**SF-21-320** 23 x 55 mm  
**SF-21-321** 23 x 60 mm  
**SF-21-322** 23 x 65 mm  
**SF-21-323** 23 x 75 mm  
 Medial Toothed Blades  
 PEEK



**SF-21-324 - SF-21-330**  
**SF-21-324** 23 x 40 mm  
**SF-21-325** 23 x 45 mm  
**SF-21-326** 23 x 50 mm  
**SF-21-327** 23 x 55 mm  
**SF-21-328** 23 x 60 mm  
**SF-21-329** 23 x 65 mm  
**SF-21-330** 23 x 75 mm  
 Lateral Serrated Blades  
 PEEK – rotating



**SF-21-331 - SF-21-337**  
**SF-21-331** 23 x 40 mm  
**SF-21-332** 23 x 45 mm  
**SF-21-333** 23 x 50 mm  
**SF-21-334** 23 x 55 mm  
**SF-21-335** 23 x 60 mm  
**SF-21-336** 23 x 65 mm  
**SF-21-337** 23 x 75 mm  
 Blunt Blades  
 PEEK – rotating

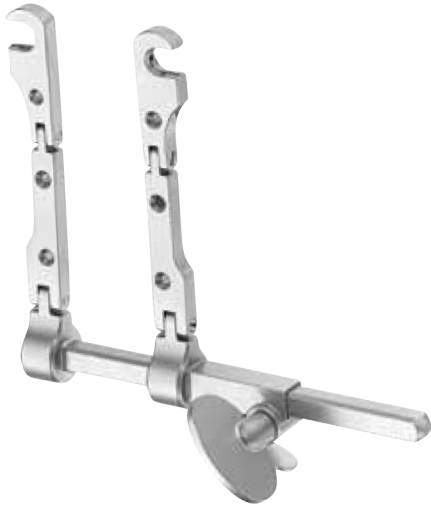

CASPAR  
**SF-21-338**  
Transverse Retractor double-hinged  
quick connect 72 mm spread, side-loading



CASPAR  
**SF-21-339**  
Longitudinal Retractor double-hinged,  
ring handle, quick connect  
185 mm  
75 mm spread, side-loading



CASPAR  
**SF-21-340**  
Specula Retractor single-hinged,  
quick connect  
115 mm  
70 mm spread, side-loading



CASPAR  
**SF-21-341**  
Quick Connect Blade  
Positioner Handle  
210 mm  
for quick connect  
blades only



**SF-21-342 - SF-21-346**  
**SF-21-342** 23 x 40 mm  
**SF-21-343** 23 x 45 mm  
**SF-21-344** 23 x 50 mm  
**SF-21-345** 23 x 55 mm  
**SF-21-346** 23 x 60 mm  
Medial Toothed Blades  
Stainless Steel  
quick connect



**SF-21-347 - SF-21-351**  
**SF-21-347** 23 x 40 mm  
**SF-21-348** 23 x 45 mm  
**SF-21-349** 23 x 50 mm  
**SF-21-350** 23 x 55 mm  
**SF-21-351** 23 x 60 mm  
Lateral Serrated Blades  
Stainless Steel  
quick connect



**SF-21-352 - SF-21-356**  
**SF-21-352** 23 x 45 mm  
**SF-21-353** 23 x 50 mm  
**SF-21-354** 23 x 55 mm  
**SF-21-355** 23 x 60 mm  
**SF-21-356** 23 x 65 mm  
Blunt Blades  
Stainless Steel  
quick connect



**SF-21-357 - SF-21-361**  
**SF-21-357** 23 x 40 mm  
**SF-21-358** 23 x 45 mm  
**SF-21-359** 23 x 50 mm  
**SF-21-360** 23 x 55 mm  
**SF-21-361** 23 x 60 mm  
Medial Toothed Blades  
Titanium  
quick connect



**SF-21-362 - SF-21-366**  
**SF-21-362** 23 x 40 mm  
**SF-21-363** 23 x 45 mm  
**SF-21-364** 23 x 50 mm  
**SF-21-365** 23 x 55 mm  
**SF-21-366** 23 x 60 mm  
Lateral Serrated Blades  
Titanium  
quick connect



**SF-21-367 - SF-21-371**  
**SF-21-367** 23 x 45 mm  
**SF-21-368** 23 x 50 mm  
**SF-21-369** 23 x 55 mm  
**SF-21-370** 23 x 60 mm  
**SF-21-371** 23 x 65 mm  
Blunt Blades  
Titanium  
quick connect

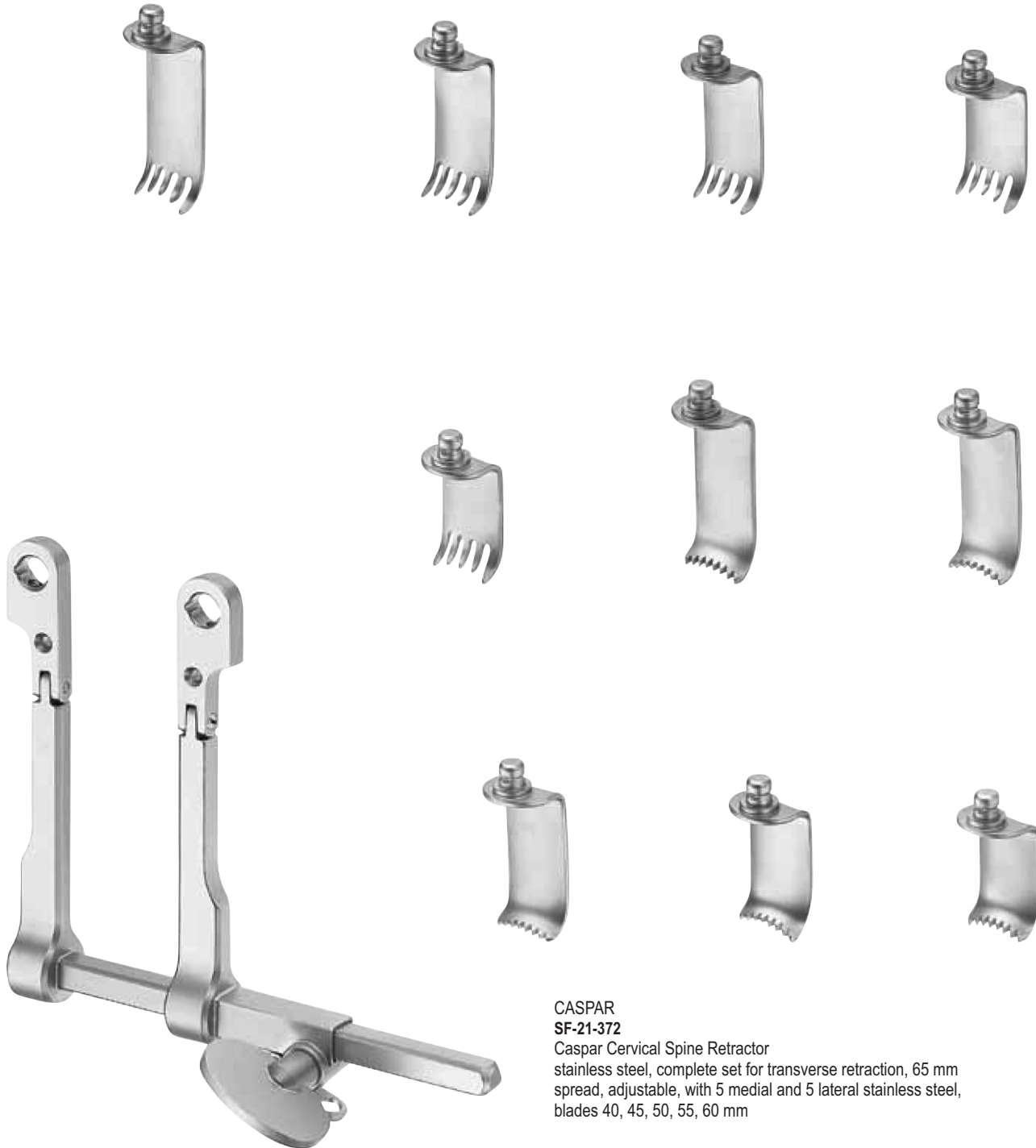

**CASPAR  
SF-21-372**  
Caspar Cervical Spine Retractor  
stainless steel, complete set for transverse retraction, 65 mm  
spread, adjustable, with 5 medial and 5 lateral stainless steel,  
blades 40, 45, 50, 55, 60 mm

**SF-21-373**  
TI Caspar Cervical Spine Retractor  
titanium, complete set for transverse retraction, 65 mm  
spread, adjustable, with 5 medial and 5 lateral titanium  
blades 40, 45, 50, 55, 60 mm



CASPAR  
**SF-21-374**  
Caspar Microdiscectomy Retractor  
for microsurgical treatment of  
herniated lumbar discs  
45 mm spread



**SF-21-375 - SF-21-383**  
SF-21-375 35 mm  
SF-21-376 40 mm  
SF-21-377 45 mm  
SF-21-378 50 mm  
SF-21-379 55 mm  
SF-21-380 60 mm  
SF-21-381 65 mm  
SF-21-382 75 mm  
SF-21-383 85 mm  
Lateral Blades



**SF-21-384 - SF-21-390**  
SF-21-384 40 mm  
SF-21-385 45 mm  
SF-21-386 50 mm  
SF-21-387 55 mm  
SF-21-388 60 mm  
SF-21-389 65 mm  
SF-21-390 70 mm  
Paraspina Blades



CASPAR  
**SF-21-391 - SF-21-400**  
SF-21-391 40 mm  
SF-21-392 45 mm  
SF-21-393 50 mm  
SF-21-394 55 mm  
SF-21-395 60 mm  
SF-21-396 65 mm  
SF-21-397 70 mm  
SF-21-398 75 mm  
SF-21-399 80 mm  
SF-21-400 85 mm  
Lumbar Speculum  
fenestrated



**SF-21-405 - SF-21-410**  
**SF-21-405** 20 x 30 mm  
**SF-21-406** 20 x 40 mm  
**SF-21-407** 20 x 50 mm  
**SF-21-408** 20 x 60 mm  
**SF-21-409** 20 x 70 mm  
**SF-21-410** 20 x 80 mm  
 McCulloch 4-teeth  
 Narrow Muscle Blades



**SF-21-411 - SF-21-416**  
**SF-21-411** 20 x 30 mm  
**SF-21-412** 20 x 40 mm  
**SF-21-413** 20 x 50 mm  
**SF-21-414** 20 x 60 mm  
**SF-21-415** 20 x 70 mm  
**SF-21-416** 20 x 80 mm  
 McCulloch 6-teeth  
 Wide Muscle Blades

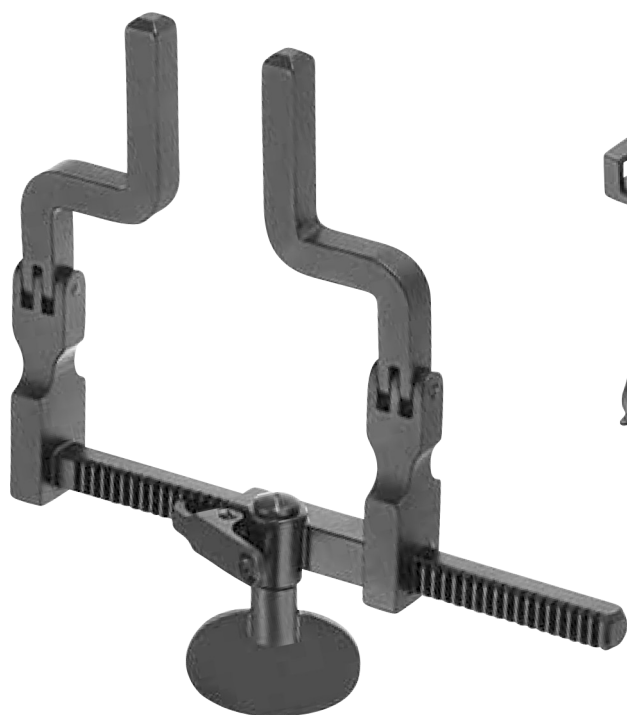

**SF-21-417 - SF-21-422**  
**SF-21-417** 20 x 30 mm  
**SF-21-418** 20 x 40 mm  
**SF-21-419** 20 x 50 mm  
**SF-21-420** 20 x 60 mm  
**SF-21-421** 20 x 70 mm  
**SF-21-422** 20 x 80 mm  
 McCulloch 2-teeth  
 Thin Muscle Blades



**SF-21-423 - SF-21-430**  
**SF-21-423** 20 mm  
**SF-21-424** 30 mm  
**SF-21-425** 40 mm  
**SF-21-426** 50 mm  
**SF-21-427** 60 mm  
**SF-21-428** 70 mm  
**SF-21-429** 80 mm  
**SF-21-430** 90 mm  
 McCulloch Hook Blades

**CASPAR**  
 McCulloch Lumbar Spine Retractor for Microdiscectomy,  
 black silicone bead  
**SF-21-401** 68 mm spread, hinged  
**SF-21-402** 68 mm spread, rigid  
**SF-21-403** 90 mm spread, rigid  
 McCulloch Lumbar Spine Retractor Tray  
**SF-21-404** Tray 265 x 265 mm for Container (not illustrated)



**SF-21-431 - SF-21-438**  
**SF-21-431** 20 mm  
**SF-21-432** 30 mm  
**SF-21-433** 40 mm  
**SF-21-434** 50 mm  
**SF-21-435** 60 mm  
**SF-21-436** 70 mm  
**SF-21-437** 80 mm  
**SF-21-438** 90 mm  
 McCulloch toothed  
 Hook Blades



**SF-21-439 - SF-21-441**  
**SF-21-439** 20 x 50 mm  
**SF-21-440** 20 x 60 mm  
**SF-21-441** 20 x 70 mm  
 McCulloch 2-teeth  
 Cervical Blades



CASPAR  
**SF-21-442 - SF-21-443**  
Caspar Vertebral Column Retractor for Laminectomy and Hemilaminectomy (Lumbar, Thoracal, Cervical), stainless steel, complete set, 145 mm spread,  
**SF-21-442** 125 mm arms, consisting of  
**SF-21-443** 145 mm spread, hinged includes Screw Driver for spreading bar



CASPAR  
**SF-21-444**  
Screw driver four spreading bar



CASPAR  
**SF-21-445**  
Blade Changing Forceps  
115 mm



**SF-21-446 - SF-21-447**  
**SF-21-446** 38 mm  
**SF-21-447** 58 mm



**SF-21-448 - SF-21-455**  
**SF-21-448** 22 x 32 mm  
**SF-21-449** 22 x 37 mm  
**SF-21-450** 22 x 43 mm  
**SF-21-451** 22 x 47 mm  
**SF-21-452** 22 x 52 mm  
**SF-21-453** 22 x 57 mm  
**SF-21-454** 22 x 62 mm  
**SF-21-455** 22 x 67 mm



**SF-21-456 - SF-21-463**  
**SF-21-456** 37 x 32 mm  
**SF-21-457** 37 x 37 mm  
**SF-21-458** 37 x 43 mm  
**SF-21-459** 37 x 47 mm  
**SF-21-460** 37 x 52 mm  
**SF-21-461** 37 x 57 mm  
**SF-21-462** 37 x 62 mm  
**SF-21-463** 37 x 67 mm



**SF-21-464 - SF-21-471**  
**SF-21-464** 57 x 32 mm  
**SF-21-465** 57 x 37 mm  
**SF-21-466** 57 x 43 mm  
**SF-21-467** 57 x 47 mm  
**SF-21-468** 57 x 52 mm  
**SF-21-469** 57 x 57 mm  
**SF-21-470** 57 x 62 mm  
**SF-21-471** 57 x 67 mm





**CASPAR**  
**SF-21-472**  
Distractor only for use in surgical procedures from the left approach the right approach for the upper cervical spine Distractor as above but with elongated toothed bar for multilevel (more than 2) distraction

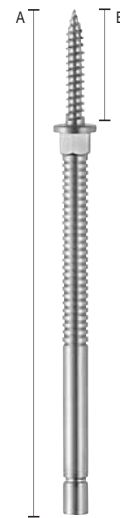

**DISTRACTION PIN A/B**  
**SF-21-473 - SF-21-476**  
**SF-21-473** 66/12 mm  
**SF-21-474** 68/14 mm  
**SF-21-475** 70/16 mm  
**SF-21-476** 72/18 mm



**TWIST DRILL**  
**SF-21-477**



**DRILL GUIDE**  
**SF-21-478**



**SCREW DRIVER**  
**SF-21-479**



**CASPAR  
SF-21-480**  
Distractor only for use in surgical procedures from the left approach the right approach for the upper cervical spine Distractor as above but with elongated toothed bar for multilevel (more than 2) distraction

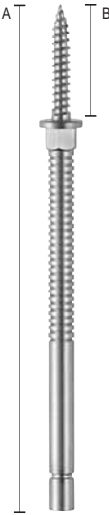

**DISTRACTION PIN A/B  
SF-21-481 - SF-21-484**  
SF-21-481 66/12 mm  
SF-21-482 68/14 mm  
SF-21-483 70/16 mm  
SF-21-484 72/18 mm



**TWIST DRILL  
SF-21-485**



**DRILL GUIDE  
SF-21-486**



**SCREW DRIVER  
SF-21-487**



CLOWARD-TYPE  
**SF-21-488**  
Vertebra Spreaders  
130 mm  
18 mm spread



**SF-21-489**  
one pointed tip  
70 mm  
arm, 80 mm spread



three pointed tips  
**SF-21-490**  
850 mm arm,  
70 mm spread  
**SF-21-491**  
100 mm  
arm, 70 mm spread



INGE  
Lamina Spreaders  
**SF-21-492 - SF-21-493**  
**SF-21-492** 165 mm  
**SF-21-493** 270 mm

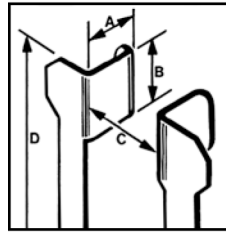

**SCOVILLE-HAVERFIELD**

	A	B	C	D
<b>SF-21-494</b>	50 mm	35 mm	140 mm	140 mm
	50 mm			
with 1 each blade 29-3165.50 and 29-3162.51				
<b>Frame only, hinged:</b>				
<b>SF-21-495</b>			140 mm	140 mm



**Toothed:**

<b>SF-21-502 - SF-21-507</b>	
<b>SF-21-502</b>	63 mm x 26 mm
<b>SF-21-503</b>	66 mm x 30 mm
<b>SF-21-504</b>	89 mm x 26 mm
<b>SF-21-505</b>	51 mm x 51 mm
<b>SF-21-506</b>	63 mm x 51 mm
<b>SF-21-507</b>	76 mm x 51 mm



**3-prongs:**

**SF-21-496** 44 mm x 38 mm

**4-prongs:**

**SF-21-497 - SF-21-501**

**SF-21-497** 41 mm x 38 mm

**SF-21-498** 66 mm x 48 mm

**SF-21-499** 48 mm x 51 mm

**SF-21-500** 63 mm x 63 mm

**SF-21-501** 82 mm x 58 mm



**Hook-shaped, blunt:**

**SF-21-508 - SF-21-509**

**SF-21-508** 50 mm

**SF-21-509** 75 mm



**Williams**  
**SF-21-510**  
for microsurgical treatment  
of herniated discs  
170 mm  
**w = 10 mm**  
**SF-21-511** 10 x 50 mm  
**SF-21-512** 10 x 60 mm  
**SF-21-513** 10 x 70 mm

**w = 20 mm**  
**SF-21-514** 20 x 50 mm  
**SF-21-515** 20 x 60 mm  
**SF-21-516** 20 x 70 mm



**Williams**  
**SF-21-517**  
for microsurgical treatment  
of herniated discs  
170 mm  
**w = 10 mm**  
**SF-21-518** 10 x 50 mm  
**SF-21-519** 10 x 60 mm  
**SF-21-520** 10 x 70 mm

**w = 20 mm**  
**SF-21-521** 20 x 50 mm  
**SF-21-522** 20 x 60 mm  
**SF-21-523** 20 x 70 mm



**CLOWARD-TYPE**  
**SF-21-524**  
 with slide lock Cervical Retractor Set with  
 slide-lock complete with 14 blades, 25 cm  
**SF-21-525 – SF-21-526**  
**SF-21-527** Retractor Body only (without blades), 25 cm

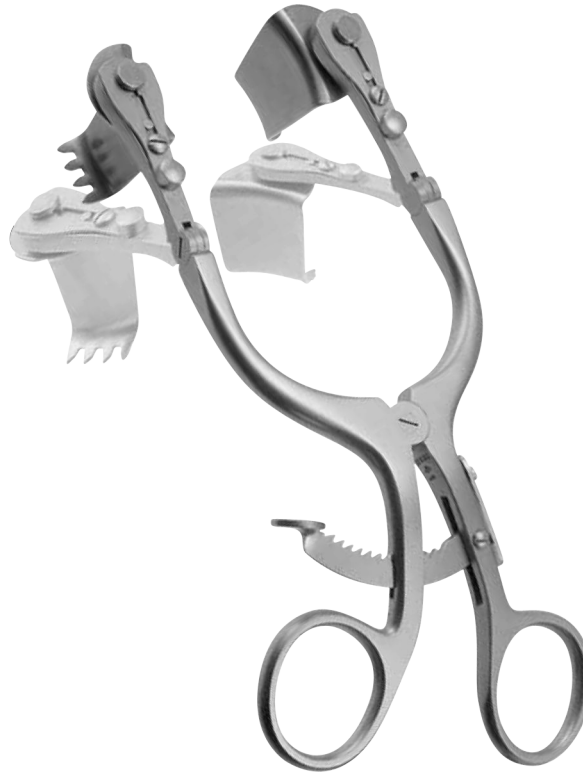

**SF-21-528**  
 Cervical Retractor Set with  
 slide-lock complete with 14 blades, 16 cm  
**SF-21-529 – SF-21-530**  
**SF-21-531** Retractor Body only (without blades),  
 160 mm



**SF-21-532 - SF-21-538**  
**SF-21-532** 25 mm  
**SF-21-533** 30 mm  
**SF-21-534** 35 mm  
**SF-21-535** 40 mm  
**SF-21-536** 45 mm  
**SF-21-537** 50 mm  
**SF-21-538** 55 mm  
 blunt



**SF-21-539 - SF-21-545**  
**SF-21-539** 25 mm  
**SF-21-540** 30 mm  
**SF-21-541** 35 mm  
**SF-21-542** 40 mm  
**SF-21-543** 45 mm  
**SF-21-544** 50 mm  
**SF-21-545** 55 mm  
 blunt

Galea Hooks



YASARGIL  
SF-21-546  
31 cm

YASARGIL  
SF-21-547  
41 cm

Dura Protecting Forceps

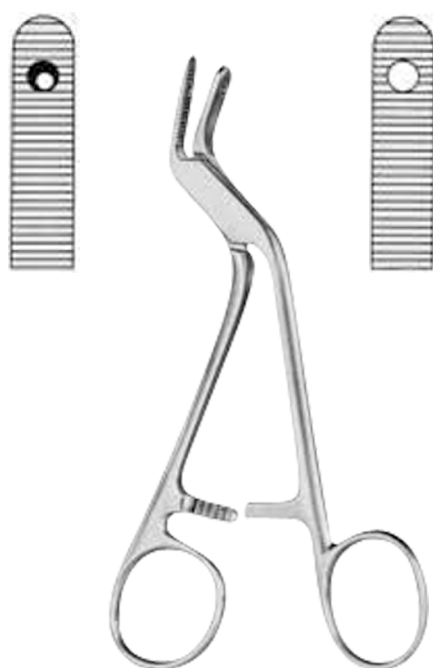

ADSON  
SF-21-548  
15 cm



**SF-21-549**  
Silver Wires Mckenzie

Elio Carrier



MCKENZIE  
**SF-21-550**  
148x40x60 mm  
One Clip Holding



MCKENZIE  
**SF-21-551**  
190x48x13 mm  
Two Clips Holding

Silver Clips



**SF-21-552**



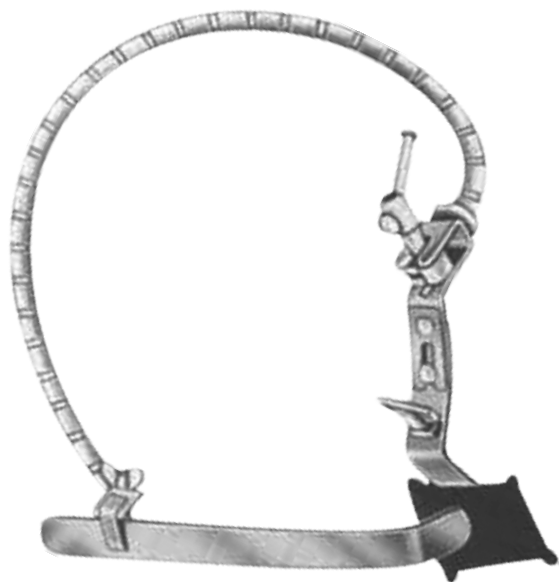

**SF-21-553**  
Complete Brain Ttractor  
Set With 1 Arm



**SF-21-554**  
Complete Brain Ttractor  
Set With 2 Arm

**SF-21-555**  
Complete Set

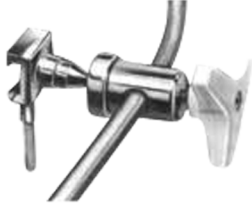

**SF-21-556**  
Ball and Socket Joint



**SF-21-557**  
Holding Rod, Head



**SF-21-558**  
Coupling Head



**SF-21-559**  
Fixation Base for skull  
Mounting Holding 1  
Flexible Arm



**SF-21-560**  
Fixation Base for skull  
Mounting, Holding 2  
Flexible Arms



**SF-21-561**  
Fixation Base for  
Mounting to 16 mm Dia.  
Holding 1 Flexible Arm

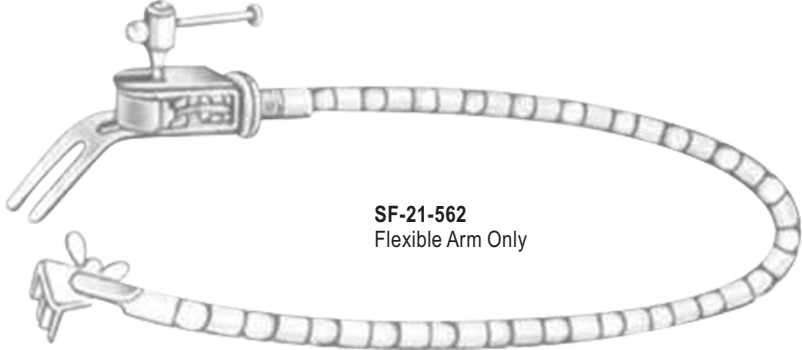

**SF-21-562**  
Flexible Arm Only



**SF-21-563**  
Support for Flat  
Brain Spatula



**SF-21-564**  
Support for Brain Spatula  
With Round Shaft



**SF-21-565**  
Holed for Ear Spatula



# Surgiforce Instruments



Opposite Surgical Association,  
Malkay Kalan, Marala Road,  
Sialkot-51050 Pakistan.



+92 523 559131



info@surgiforce.com  
sales@surgiforce.com



www.surgiforce.com



## Our Certifications:

ISO 9001

CE Certified

EN 13485:2012

ISO 7153-1

ISO 7151

ISO 17664:2004

ISO 13402

ISO 15223

